



## SPECIFICATIONS

1. THIS SPECIFICATIONS APPLY TO RK09L12B0 POTENTIOMETER.

2. CONTENTS OF THIS SPECIFICATIONS.

F1689807M  
K092G000C

3. MARKING

· MARKING ON ALL UNITS  
DATE CODE, RESIST. VALUE, TAPER

4. REMARKS

· FURNISH PACKAGE  
NUT: 1, WASHER: 1

· CAUTION

Regardless of the suggested applications of these products being introduced in the specifications, when using them for equipment and devices requiring a high degree of safety, respective manufacturers will please preserve safety of the planned equipment and devices by providing necessary protective circuits and redundancy circuits and reconfirm if safety is being duly preserved.

Products being introduced in the specifications have been designed and manufactured for applications to ordinary electronic equipment and devices such as the AV equipment, electric home appliances, office machines and communications equipment. Consequently, when employing these products for applications requiring a high degree of safety and reliability such as the medical equipment, aviation and aircraft equipment, space equipment and burglar alarm equipment, the using manufacturers will please thoroughly study the proprieties of these products for the planned applications.

Although we are exerting our best efforts to maintain the quality of these products, we cannot guarantee that they will never cause short circuiting and open circuitry. Therefore, when designing an equipment or device with which the priority is given to the safety, you will please carefully study the influences to the whole equipment of a single function failure of Potentiometers and Encoders in advance to make out a fail-safe design providing.

# SPECIFICATIONS

## ELECTRICAL

1. Total resistance : 50k  $\Omega$   $\pm$  20%
2. Rated power : 0.05 W
3. Rated voltage :

The rated voltage shall be the voltage of D.C. or A.C. (commercial frequency, effective value) corresponding to the rated power (dissipation), and be obtained from the following formula. When the obtained rated voltage exceeds the maximum working voltage given in the following, however, the maximum working voltage of the following shall be the rated voltage.

$$E = \sqrt{P \cdot R} \text{ (V)}$$

Where E : Rated voltage (V)  
 P : Rated power (dissipation) (W)  
 R : Nominal total resistance ( $\Omega$ )

Maximum working voltage : 50 V A.C. , 10 V D.C.

4. Resistance taper : A
  
5. Maximum attenuation level at full C.C.W. position : 90 dBmin.
6. Insertion loss at full C.W. position : 0.1dB max.
7. Sliding noise : Less than 100mV. (Measured by JIS C 6443)
  
8. Insulation resistance : More than 100 M $\Omega$  at 250V D.C.
9. Withstand voltage: 300V A.C. for 1 minute.
10. Gang error : 3 dB max.

to -40dB less than 0dB

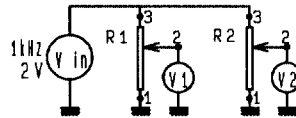

## MECHANICAL

1. Total rotational angle : 300°  $\pm$  5°
  2. Rotational torque : 2~25mN·m (Rotational speed 60°/sec.)
  3. Stopper strength : No damage with an application of 0.5N·m.
  4. Resistance to soldering heat : Please refer to the attached
  5. Bushing nut tightening strength : Tightening torque to be no greater than 1N·m.
- \*Pay attention otherwise the strength may not be assured.

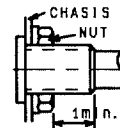

6. Push/pull strength :  
 After installing the potentiometer, no damages with an application of push or pull force 80N for 10 seconds.
7. Shaft wobble :  
 The resistor shall be mounted by soldering the mounting legs on the panel and a side thrust of 50mN·m at the end of the shaft shall be applied, then the total play of the shaft shall not exceed 0.6xL/20 mm-p.  
 (L is the length between mounting surface and measuring point.)

## ENDURANCE

1. Rotational life : 15,000 cycles min.

## NOTE

1. Operating temperature range : -10~+70°C
2. Storage temperature range : -20~+80°C
3. The items except above mentioned items shall meet or exceed JIS C 6443.
4. The use for HomeAudio.
5. This type is protected against sulfides.

<b>ALPS ELECTRIC CO., LTD.</b>				
APPD.	CHKD.	DSGD.	TITLE	
Aug. 19, '93	Aug. 19, '93	Aug. 19, '93	F 1689807M	
S. Aizawa	M. Satoh	Y. Saitoh	DOCUMENT NO.	
SYMB	DATE	APPD	CHKD	DSGD
				L X

## SPECIFICATIONS

Resistance to soldering heat :

There shall be no evidence of poor contact between resistance element and terminals, or any physical damages as a result of soldering.

\*Dip soldering :

Condition of soldering :

Soldering shall be certified with following condition.

Substrate to be soldered :

Copper clad laminated phenol board in one surface of 1.6mm thickness.

Solder flux :

Flux of 0.82 specific weight in bubbling type solder fluxcoating apparatus shall be used and bubbling surface height shall be defined substantially as half thickness of substrate.

Flux shall not flow up on substrate surface.

Preheating

Surface temperature of substrate shall be settled within 100°C in two minutes.

Dip soldering :

To be performed in 260±5°C , 5±1 sec.

Please use the above process only one or two times.

\*Manual soldering :

To be performed in three seconds within 350°C.

 <b>ALPS ELECTRIC CO., LTD.</b>				
APPD.	CHKD.	DSGD.	TITLE	
<i>Aug. 19. '93</i>	<i>Aug. 19. '93</i>	<i>Aug. 19. '93</i>	F 1689807M	
<i>S. Aizawa</i>	<i>M. Satoh</i>	<i>Y. Saitoh</i>	DOCUMENT NO.	
SYMB	DATE	APPD	CHKD	DSGD



ALPS ELECTRIC CO., LTD  
1-7 YUKIGAYA OTSUKA-CHO OTA-KU TOKYO JAPAN

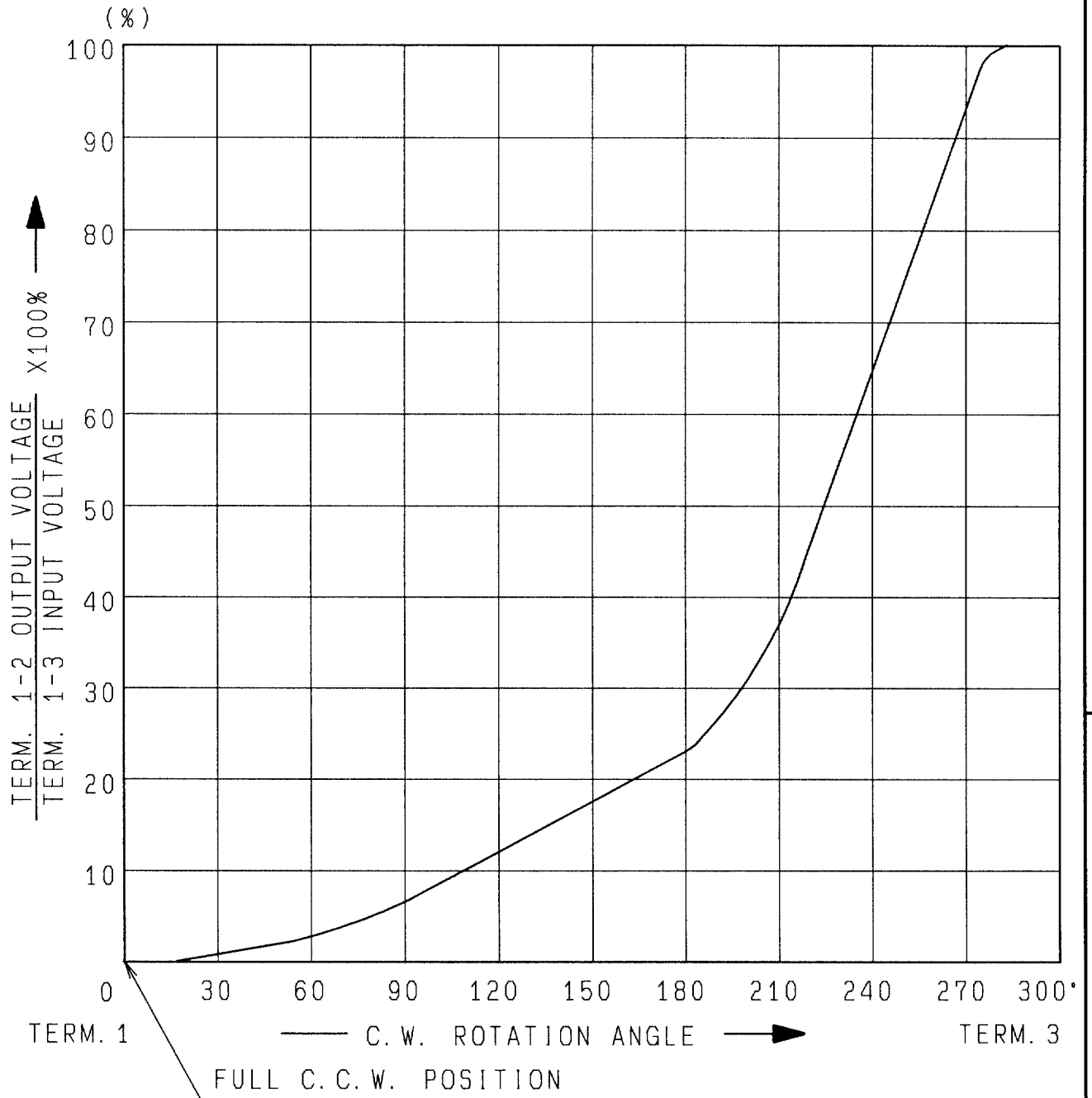

AT 150° C.W. SHAFT ROTATION FROM FULL C.C.W. POSITION VOLTAGE PERCENT SHALL FALL WITHIN THE LIMITS OF 10~25 PERCENT.

					APPD.	CHKD.	DSGD.	NAME
					Sep. 07. '93	Sep. 07. '93	Sep. 07. '93	RESISTANCE TAPER (A)
					K. Magami	K. Sasaki	K. Suzuki	DOCUMENT NO.
SYMB	DATE	APPD	CHKD	DSGD				F1689807M

LX

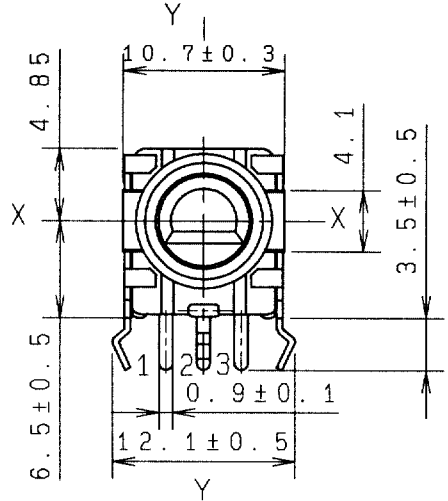
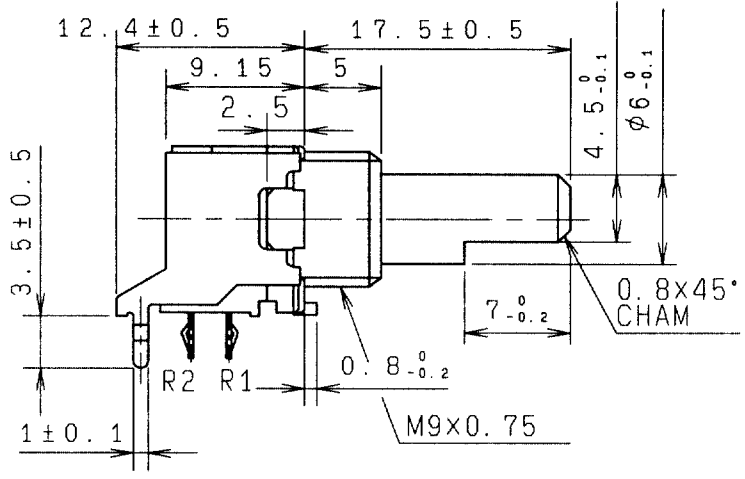

端子取付穴寸法図 (挿入側より見た図)  
 (許容差±0.1)  
 MOUNTING HOLE DETAIL  
 (TOLERANCE±0.1)  
 VIEWED FROM MOUNTING SIDE

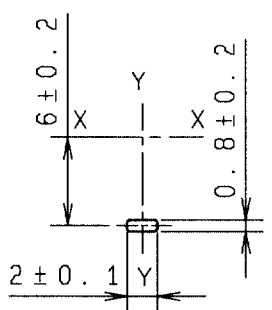
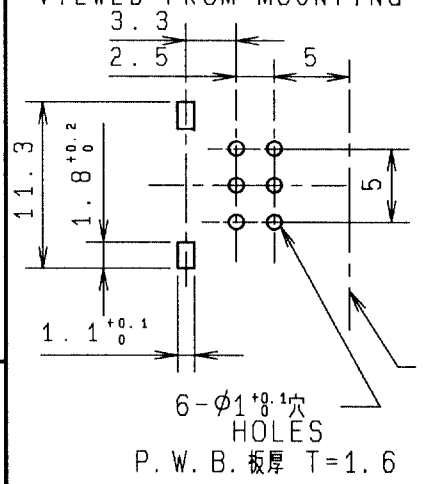

シャフト止め 詳細図  
 LOCATING LUG  
 DETAIL  
 軸受取付面  
 BUSHING  
 MOUNTING  
 SURFACE

軸はセンター位置を示す  
 SHAFT SHOWN IN  
 CENTER POSITION

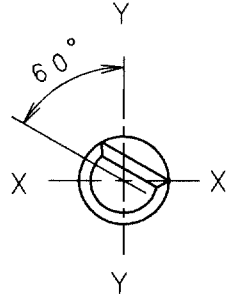

軸は、反時計方向に  
 回し切った状態を示す  
 SHAFT SHOWN  
 IN FULL C.C.W  
 POSITION.

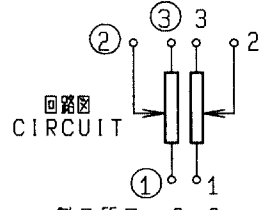

製品質量: 6.6g  
 NET WEIGHT

指定なき部分の許容差 TOLERANCES UNLESS OTHERWISE SPEC	
$L \leq 10$	±0.3
$10 < L < 100$	±0.5
$100 \leq L$	±0.8
角度 ANGULAR DIMENSION	±5°

PART NO.		NAME		MATERIAL NAME / CODE		FINISH	
<b>ALPS ELECTRIC CO., LTD.</b>							
DSGN. 1-設計1番 Y. Saitoh 93-10-01				SCALE 2/1		NO. F1689807M	
CHKD. SEC M. Satoh 93-10-01						TITLE 9形1軸2連VR組立図 FIGURE	
APPD. SEC S. Aizawa 93-10-01						DOCUMENT NO. G01	
SYMB	DATE	APPD	CHKD	DSGD	UNIT mm	K092G000C	