

Aluminum Capacitors Axial Standard Miniature

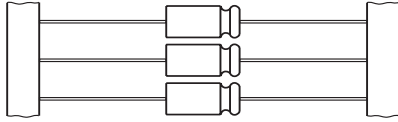
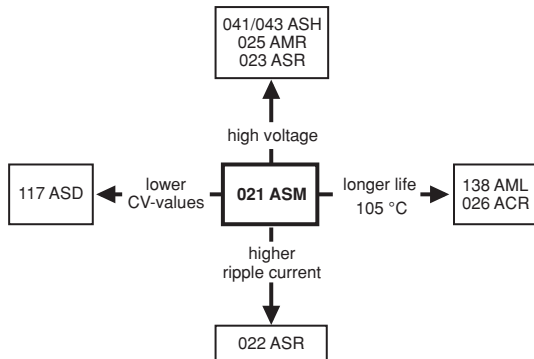

Fig. 1 Component outlines.



FEATURES

- Polarized aluminum electrolytic capacitors, non-solid electrolyte.
- Axial leads, cylindrical aluminum case, insulated with a blue sleeve.
- Mounting ring version not available in insulated form.
- Taped versions up to case $\varnothing 15 \times 30$ mm available for automatic insertion
- Charge and discharge proof
- Miniaturized, high CV-product per unit volume.

APPLICATIONS

- General purpose, industrial, automotive, audio-video
- Coupling, decoupling, smoothing, filtering, buffering
- Portable and mobile equipment (small size, low mass)
- Low mounting height boards, vibration and shock resistant.

MARKING

The capacitors are marked (where possible) with the following information:

- Rated capacitance (in μF).
- Tolerance on rated capacitance, code letter in accordance with IEC 60062 (M for $\pm 20\%$).
- Rated voltage (in V).
- Upper category temperature (85 °C).
- Date code in accordance with IEC 60062.
- Code for factory of origin.
- Name of manufacturer.
- Band to indicate the negative terminal.
- '+' sign to identify the positive terminal (not for case sizes $L < 18$ mm).
- Series number (021).

QUICK REFERENCE DATA

DESCRIPTION	VALUE	
Nominal case sizes ($\varnothing D \times L$ in mm)	4.5 × 10 to 10 × 25	10 × 30 to 21 × 38
Rated capacitance range, C_R	0.47 to 15000 μF	
Tolerance on C_R	$\pm 20\%$	
Rated voltage range, U_R	6.3 to 100 V	
Category temperature range	-40 to +85 °C	
Endurance test at 85 °C:		
$U_R = 6.3$ to 25 V	1000 hours	5000 hours
$U_R = 40$ to 100 V	2000 hours	5000 hours
Endurance test at 105 °C	-	1500 hours
Useful life at 85 °C	2500 hours	8000 hours
Useful life at 40 °C, $1.4 \times I_R$ applied	70000 hours	200000 hours
Shelf life at 0 V, 85 °C	500 hours	500 hours
Based on sectional specification	IEC 60384-4/EN130300	
Climatic category IEC 60068	40/085/56	

SELECTION CHART FOR C_R , U_R AND RELEVANT NOMINAL CASE SIZES ($\varnothing D \times L$ in mm)

C_R (μF)	U_R (V)						
	6.3	10	16	25	40	63	100
0.47	-	-	-	-	-	4.5 × 10	-
1.0	-	-	-	-	-	4.5 × 10	4.5 × 10
2.2	-	-	-	-	-	4.5 × 10	4.5 × 10
3.3	-	-	-	-	-	4.5 × 10	-
4.7	-	-	-	-	-	4.5 × 10	4.5 × 10
10	-	-	-	-	-	4.5 × 10	6 × 10
15	-	-	-	-	-	4.5 × 10	8 × 11
	-	-	-	-	-	-	6.5 × 18
	-	-	-	-	4.5 × 10	6 × 10	8 × 11
22	-	-	-	-	-	-	6.5 × 18
	-	-	-	-	-	6 × 10	6.5 × 18
33	-	-	-	-	-	6 × 10	6.5 × 18

SELECTION CHART FOR C_R , U_R AND RELEVANT NOMINAL CASE SIZES ($\varnothing D \times L$ in mm)							
C_R (μF)	U_R (V)						
	6.3	10	16	25	40	63	100
47	-	-	-	4.5 x 10	6 x 10	8 x 11	8 x 18
	-	-	-	-	-	6.5 x 18	-
68	-	-	4.5 x 10	-	-	8 x 11	10 x 18
	-	-	-	-	-	6.5 x 18	-
100	-	4.5 x 10	-	6 x 10	8 x 11	8 x 18	10 x 25
	-	-	-	-	6.5 x 18	-	10 x 30
150	-	-	6 x 10	8 x 11	8 x 18	10 x 18	12.5 x 30
	-	-	-	6.5 x 18	-	-	-
220	-	6 x 10	8 x 11	6.5 x 18	10 x 18	10 x 25	12.5 x 30
	-	-	-	-	-	10 x 30	-
330	-	8 x 11	6.5 x 18	8 x 18	10 x 25	12.5 x 30	15 x 30
470	8 x 11	6.5 x 18	8 x 18	10 x 18	10 x 25	12.5 x 30	18 x 30
	-	-	-	-	10 x 30	-	-
680	-	8 x 18	10 x 18	10 x 25	12.5 x 30	15 x 30	18 x 38
	-	-	-	10 x 30	-	-	-
1000	8 x 18	10 x 18	10 x 25	12.5 x 30	12.5 x 30	18 x 30	21 x 38
	-	-	10 x 30	-	-	-	-
1500	-	10 x 25	12.5 x 30	12.5 x 30	15 x 30	18 x 38	-
	-	10 x 30	-	-	-	-	-
2200	10 x 25	12.5 x 30	12.5 x 30	15 x 30	18 x 30	21 x 38	-
3300	-	12.5 x 30	15 x 30	18 x 30	18 x 38	-	-
4700	-	15 x 30	18 x 30	18 x 38	21 x 38	-	-
6800	-	18 x 30	18 x 38	21 x 38	-	-	-
10000	-	18 x 38	21 x 38	-	-	-	-
15000	-	21 x 38	-	-	-	-	-

DIMENSIONS in millimeters **AND AVAILABLE FORMS**

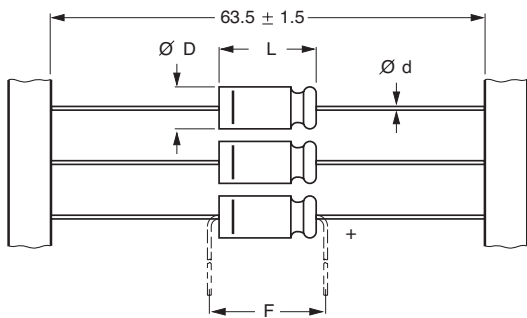

Form BR: Taped on reel.
Form BA: Taped in box (ammopack).
Case $\varnothing D \times L = 4.5 \times 10$ to 8×11 mm.

Fig.2 Forms BA and BR.

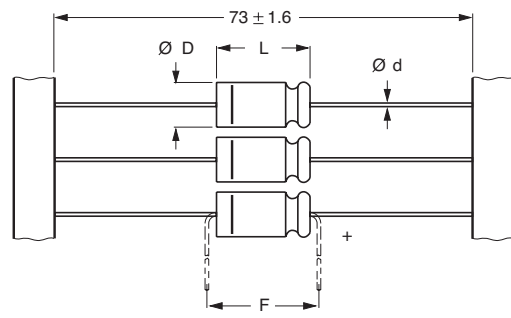

Form BR: Taped on reel,
case $\varnothing D \times L = 6.5 \times 18$ to 15×30 mm.
Form BA: Taped in box (ammopack),
case $\varnothing D \times L = 6.5 \times 18$ to 10×25 mm.

Fig.3 Forms BA and BR.

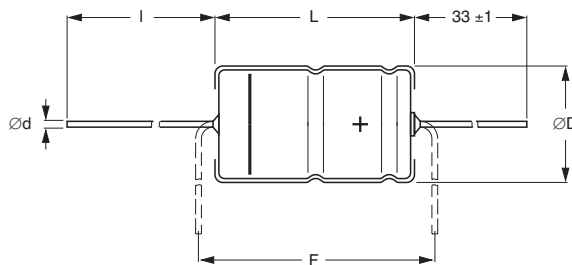

Form AA: Axial in box.
Case $\varnothing D \times L = 10 \times 30$ to 21×38 mm.

Fig.4 Form AA.

Table 1

AXIAL; DIMENSIONS in millimeters, MASS AND PACKAGING QUANTITIES										
NOMINAL CASE SIZE $\varnothing D \times L$	CASE CODE	AXIAL: FORM AA, BA, and BR					MASS (g)	PACKAGING QUANTITIES		
		$\varnothing d$	l	$\varnothing D_{max}$	L_{max}	F_{min}		FORM AA	FORM BA	FORM BR
4.5 × 10	2	0.6	–	5.0	10.5	15	≈0.50	–	1000	3000
6 × 10	3	0.6	–	6.3	10.5	15	≈0.70	–	1000	1000
8 × 11	5a	0.6	–	8.5	11.5	15	≈1.1	–	500	500
6.5 × 18	4	0.8	–	6.9	18.5	25	≈1.3	–	1000	1000
8 × 18	5	0.8	–	8.5	18.5	25	≈1.7	–	500	500
10 × 18	6	0.8	–	10.5	18.5	25	≈2.5	–	500	500
10 × 25	7	0.8	–	10.5	25.0	30	≈3.3	–	500	500
10 × 30	00	0.8	55 ±1	10.5	30.5	35	≈4.8	340	–	500
12.5 × 30	01	0.8	55 ±1	13.0	30.5	35	≈7.4	260	–	400
15 × 30	02	0.8	55 ±1	15.5	30.5	35	≈11.7	300	–	250
18 × 30	03	0.8	55 ±1	18.5	30.5	35	≈12.9	200	–	–
18 × 38	04	0.8	34 ±1	18.5	39.0	44	≈19.0	125	–	–
21 × 38	05	0.8	34 ±1	21.5	39.0	44	≈24.0	100	–	–

Note

- Detailed tape dimensions see section 'PACKAGING'.

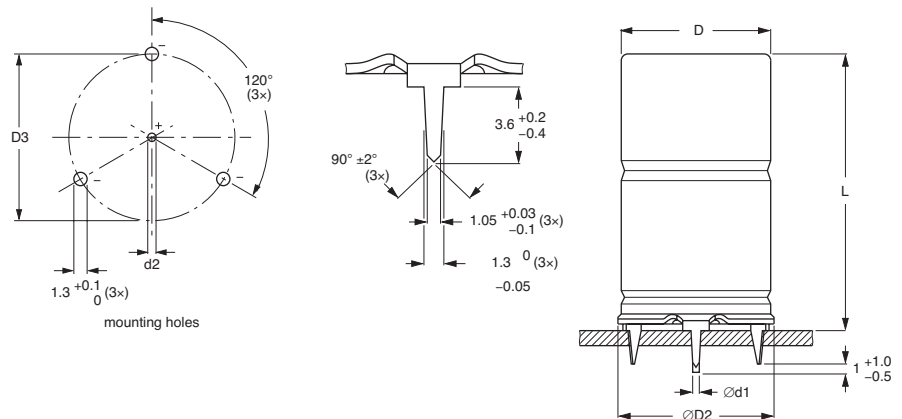
 Fig. 5 Mounting hole diagram and outline; **Form MR**; with mounting ring and pins.

Form MR: case $\varnothing D \times L = 15 \times 30$ to 21×38 mm.
 Case not insulated (insulation on request).
 Especially for applications with severe shocks and vibrations

Table 2

MOUNTING RING; DIMENSIONS in millimeters, MASS AND PACKAGING QUANTITIES								
NOMINAL CASE SIZE $\varnothing D \times L$	CASE CODE	MOUNTING RING: FORM MR					MASS (g)	PACKAGING QUANTITIES
		$\varnothing d1$	$\varnothing d2$	$\varnothing D2_{max}$	$D3$	L_{max}		
15 × 30	02	0.8	1.0 +0.4	17.5	16.5 ±0.2	33	≈11.7	200
18 × 30	03	0.8	1.0 +0.4	19.5	18.5 ±0.2	33	≈12.9	240
18 × 38	04	0.8	1.0 +0.4	19.5	18.5 ±0.2	42	≈19.0	100
21 × 38	05	0.8	1.0 +0.4	22.5	21.5 ±0.2	42	≈24.0	100

ELECTRICAL DATA	
SYMBOL	DESCRIPTION
C_R	rated capacitance at 100 Hz, tolerance $\pm 20\%$
I_R	rated RMS ripple current at 100 Hz, 85 °C
I_{L5}	max. leakage current after 5 minutes at U_R
Tan δ	max. dissipation factor at 100 Hz
ESR	equivalent series resistance at 100 Hz (calculated from tan δ_{max} and C_R)
Z	max. impedance at 10 kHz

Note

1. Unless otherwise specified, all electrical values in Table 3 apply at $T_{amb} = 20\text{ °C}$, $P = 86$ to 106 kPa , $RH = 45$ to 75% .

Table 3

ELECTRICAL DATA AND ORDERING INFORMATION											
U_R (V)	C_R 100 Hz (μF)	NOMINAL CASE SIZE $\varnothing D \times L$ (mm)	I_R 100 Hz 85 °C (mA)	I_{L5} 5 min (μA)	Tan δ 100 Hz	ESR 100 Hz (Ω)	Z 10 kHz (Ω)	CATALOG NUMBER 2222 021			
								IN BOX FORM AA	TAPED ON REEL FORM BR	TAPED IN BOX FORM BA	MOUNTING RING FORM MR
6.3	470	8 × 11	260	10	0.25	0.85	0.64	–	23471	33471	–
	1000	8 × 18	440	17	0.25	0.4	0.5	–	23102	33102	–
	2200	10 × 25	710	32	0.29	0.21	0.16	–	90588	90589	–
10	100	4.5 × 10	100	6	0.20	3.2	2.0	–	24101	34101	–
	220	6 × 10	160	8.4	0.20	1.5	0.91	–	24221	34221	–
	330	8 × 11	230	11	0.20	1.0	0.61	–	24331	34331	–
	470	6.5 × 18	310	13	0.20	0.68	0.43	–	24471	34471	–
	680	8 × 18	400	18	0.20	0.47	0.29	–	24681	34681	–
	1000	10 × 18	550	24	0.20	0.32	0.20	–	24102	34102	–
	1500	10 × 25	690	34	0.23	0.25	0.18	–	90524	90525	–
	1500	10 × 30	740	34	0.23	0.245	0.18	14152	24152	–	–
	2200	12.5 × 30	980	48	0.25	0.177	0.095	14222	24222	–	–
	3300	12.5 × 30	1090	70	0.27	0.128	0.095	14332	24332	–	–
	4700	15 × 30	1320	98	0.29	0.100	0.07	14472	24472	–	44472
	6800	18 × 30	1590	140	0.34	0.079	0.065	14682	–	–	44682
	10000	18 × 38	2090	204	0.40	0.064	0.04	14103	–	–	44103
15000	21 × 38	2250	304	0.50	0.054	0.035	14153	–	–	44153	
16	68	4.5 × 10	90	6.2	0.16	3.8	2.4	–	25689	35689	–
	150	6 × 10	140	8.8	0.16	1.7	1.1	–	25151	35151	–
	220	8 × 11	210	11	0.16	1.2	0.73	–	25221	35221	–
	330	6.5 × 18	290	15	0.16	0.77	0.48	–	25331	35331	–
	470	8 × 18	380	19	0.16	0.55	0.34	–	25471	35471	–
	680	10 × 18	500	26	0.16	0.38	0.24	–	25681	35681	–
	1000	10 × 25	660	36	0.16	0.26	0.18	–	90517	90518	–
	1000	10 × 30	700	36	0.16	0.260	0.175	15102	25102	–	–
	1500	12.5 × 30	950	52	0.19	0.205	0.095	15152	25152	–	–
	2200	12.5 × 30	1040	74	0.21	0.150	0.095	15222	25222	–	–
	3300	15 × 30	1290	110	0.23	0.111	0.07	15332	25332	–	45332
	4700	18 × 30	1560	154	0.25	0.087	0.065	15472	–	–	45472
	6800	18 × 38	2040	222	0.30	0.070	0.04	15682	–	–	45682
10000	21 × 38	2170	324	0.36	0.058	0.035	15103	–	–	45103	
25	47	4.5 × 10	80	6.4	0.14	4.8	2.6	–	26479	36479	–
	100	6 × 10	150	9	0.14	2.3	1.2	–	26101	36101	–
	150	8 × 11	190	12	0.14	1.5	0.80	–	90534	90535	–
	150	6.5 × 18	210	12	0.14	1.5	0.80	–	26151	36151	–
	220	6.5 × 18	250	15	0.14	1.0	0.55	–	26221	36221	–
	330	8 × 18	340	21	0.14	0.68	0.36	–	26331	36331	–
	470	10 × 18	450	28	0.14	0.48	0.26	–	26471	36471	–
	680	10 × 25	560	38	0.14	0.33	0.18	–	90527	90528	–
	680	10 × 30	640	38	0.14	0.323	0.175	16681	26681	–	–
	1000	12.5 × 30	840	54	0.14	0.220	0.095	16102	26102	–	–
	1500	12.5 × 30	950	79	0.17	0.179	0.095	16152	26152	–	–

ORDERING EXAMPLE

Electrolytic capacitor 021 series

1000 $\mu\text{F}/16\text{ V}$; $\pm 20\%$ Nominal case size: $\varnothing 10 \times 25\text{ mm}$; Form BA

Catalog number: 2222 021 90518.



ELECTRICAL DATA AND ORDERING INFORMATION											
U _R (V)	C _R 100 Hz (μF)	NOMINAL CASE SIZE ØD × L (mm)	I _R 100 Hz 85 °C (mA)	I _{L5} 5 min (μA)	Tan δ 100 Hz	ESR 100 Hz (Ω)	Z 10 kHz (Ω)	CATALOG NUMBER 2222 021			
								IN BOX FORM AA	TAPED ON REEL FORM BR	TAPED IN BOX FORM BA	MOUNTING RING FORM MR
25	2200	15 × 30	1180	114	0.19	0.132	0.07	16222	26222	-	46222
	3300	18 × 30	1470	169	0.21	0.099	0.065	16332	-	-	46332
	4700	18 × 38	1920	239	0.23	0.079	0.04	16472	-	-	46472
	6800	21 × 38	2070	344	0.28	0.064	0.035	16682	-	-	46682
40	22	4.5 × 10	60	5.8	0.11	8.0	3.2	-	27229	37229	-
	47	6 × 10	110	7.8	0.11	3.8	1.5	-	27479	37479	-
	100	8 × 11	170	12	0.11	1.8	0.70	-	90537	90538	-
	100	6.5 × 18	190	12	0.11	1.8	0.70	-	27101	37101	-
	150	8 × 18	250	16	0.11	1.1	0.47	-	27151	37151	-
	220	10 × 18	330	22	0.11	0.8	0.32	-	27221	37221	-
	330	10 × 25	430	30	0.11	0.53	0.21	-	27331	37331	-
	470	10 × 25	520	42	0.11	0.37	0.18	-	90514	90515	-
	470	10 × 30	590	42	0.12	0.404	0.175	17471	27471	-	-
	680	12.5 × 30	800	58	0.12	0.297	0.110	17681	27681	-	-
	1000	12.5 × 30	900	84	0.12	0.190	0.110	17102	27102	-	-
	1500	15 × 30	1120	124	0.15	0.159	0.07	17152	27152	-	47152
	2200	18 × 30	1390	180	0.17	0.118	0.065	17222	-	-	47222
	3300	18 × 38	1810	268	0.19	0.090	0.04	17332	-	-	47332
	4700	21 × 38	1940	380	0.21	0.072	0.035	17472	-	-	47472
	63	0.47	4.5 × 10	8	4.1	0.09	310	120	-	28477	38477
1		4.5 × 10	12	4.1	0.09	150	55	-	28108	38108	-
2.2		4.5 × 10	21	4.3	0.09	65	25	-	28228	38228	-
3.3		4.5 × 10	25	4.4	0.09	44	17	-	28338	38338	-
4.7		4.5 × 10	31	4.6	0.09	31	12	-	28478	38478	-
10		4.5 × 10	50	5.3	0.08	13	5.5	-	28109	38109	-
15		4.5 × 10	55	5.9	0.08	8.5	3.7	-	28159	38159	-
22		6 × 10	90	6.8	0.08	5.8	2.5	-	28229	38229	-
33		6 × 10	100	8.2	0.08	3.9	1.7	-	28339	38339	-
47		8 × 11	140	10	0.08	2.7	1.2	-	90541	90542	-
47		6.5 × 18	150	10	0.08	2.7	1.2	-	28479	38479	-
68		8 × 11	160	13	0.08	1.9	0.81	-	90544	90545	-
68		6.5 × 18	170	13	0.08	1.9	0.81	-	28689	38689	-
100		8 × 18	250	17	0.08	1.3	0.55	-	28101	38101	-
150		10 × 18	320	23	0.08	0.85	0.37	-	28151	38151	-
220		10 × 25	430	32	0.08	0.60	0.25	-	90511	90512	-
220		10 × 30	480	32	0.08	0.614	0.26	18221	28221	-	-
330		12.5 × 30	610	46	0.08	0.409	0.19	18331	28331	-	-
470		12.5 × 30	700	63	0.08	0.287	0.13	18471	28471	-	-
680		15 × 30	890	90	0.08	0.199	0.095	18681	28681	-	48681
1000	18 × 30	1170	130	0.08	0.135	0.075	18102	-	-	48102	
1500	18 × 38	1530	193	0.11	0.122	0.045	18152	-	-	48152	
2200	21 × 38	1780	281	0.13	0.099	0.040	18222	-	-	48222	
100	1	4.5 × 10	14	4.2	0.08	130	90	-	29108	39108	-
	2.2	4.5 × 10	20	4.4	0.08	58	41	-	29228	39228	-
	4.7	4.5 × 10	30	4.9	0.08	27	19	-	29478	39478	-
	10	6 × 10	65	6	0.08	13	9	-	29109	39109	-
	15	8 × 11	77	7	0.08	8.5	6	-	90547	90548	-
	15	6.5 × 18	85	7	0.08	8.5	6	-	29159	39159	-
	22	8 × 11	95	8.4	0.08	5.8	4.1	-	90551	90552	-
	22	6.5 × 18	100	8.4	0.08	5.8	4.1	-	29229	39229	-
	33	6.5 × 18	120	10.6	0.08	3.9	2.7	-	29339	39339	-
	47	8 × 18	160	13.4	0.08	2.7	1.9	-	29479	39479	-
	68	10 × 18	220	17.6	0.08	1.9	1.3	-	29689	39689	-
	100	10 × 25	300	24	0.08	1.3	0.9	-	90531	90532	-
	100	10 × 30	340	24	0.07	1.150	1.0	19101	29101	-	-
	150	12.5 × 30	490	34	0.07	0.645	0.61	19151	29151	-	-
	220	12.5 × 30	560	48	0.08	0.610	0.56	19221	29221	-	-
	330	15 × 30	740	70	0.09	0.420	0.40	19331	29331	-	49331
	470	18 × 30	980	98	0.09	0.310	0.29	19471	-	-	49471
	680	18 × 38	1260	140	0.09	0.195	0.18	19681	-	-	49681
1000	21 × 38	1470	204	0.10	0.160	0.15	19102	-	-	49102	



ADDITIONAL ELECTRICAL DATA			
PARAMETER	CONDITIONS	VALUE	
		AXIAL	MOUNTING RING
Voltage			
Surge voltage		$U_s \leq 1.15 \times U_R$	
Reverse voltage		$U_{rev} \leq 1 V$	
Current			
Leakage current	after 1 minute at U_R	$I_{L1} \leq 0.006C_R \times U_R + 4 \mu A$	
	after 5 minutes at U_R	$I_{L5} \leq 0.002C_R \times U_R + 4 \mu A$	
Inductance			
Equivalent series inductance (ESL)	case $\varnothing D \times L$ mm:		
	4.5 × 10	typ. 10 nH	–
	6 × 10	typ. 22 nH	–
	8 × 11	typ. 85 nH	–
	6.5 × 18	typ. 25 nH	–
	8 × 18	typ. 40 nH	–
	10 × 18	typ. 61 nH	–
	10 × 25	typ. 38 nH	–
	10 × 30	typ. 38 nH	–
	12.5 × 30	typ. 46 nH	–
	15 × 30	typ. 48 nH	typ. 39 nH
	18 × 30	typ. 50 nH	typ. 39 nH
	18 × 38	typ. 54 nH	typ. 39 nH
	21 × 38	typ. 59 nH	typ. 39 nH

CAPACITANCE (C)

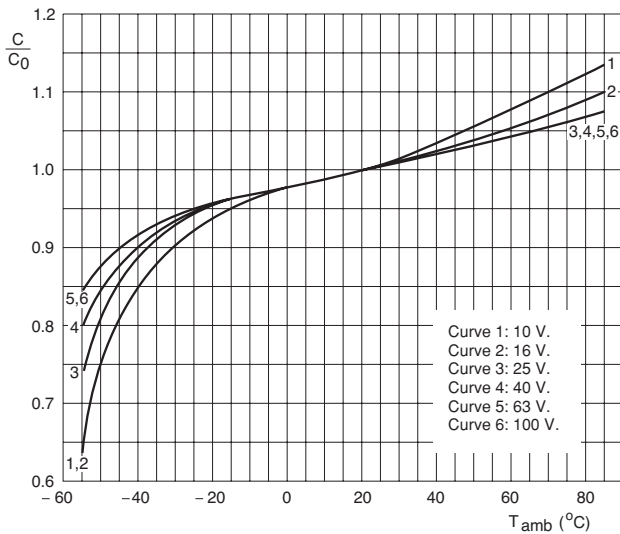

Case $\varnothing D \times L = 4.5 \times 10$ to 10×25 mm.

C_0 = capacitance at 20 °C, 100 Hz.

Fig.6 Typical multiplier of capacitance as a function of ambient temperature.

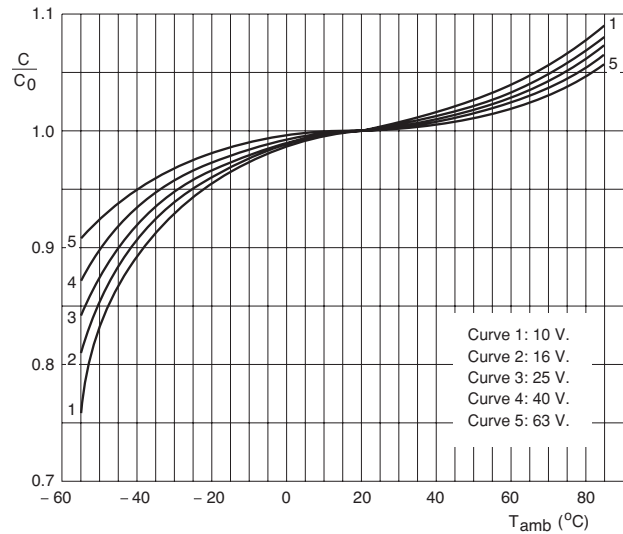

Case $\varnothing D \times L = 10 \times 30$ to 21×38 mm.

C_0 = capacitance at 20 °C, 100 Hz.

Fig.7 Typical multiplier of capacitance as a function of ambient temperature.

CAPACITANCE (C)

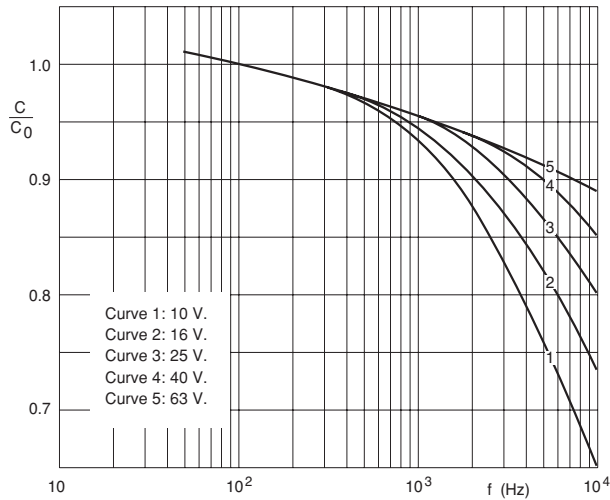

C_0 = capacitance at 20 °C, 100 Hz.

Fig.8 Typical multiplier of capacitance as a function of frequency.

EQUIVALENT SERIES RESISTANCE (ESR)

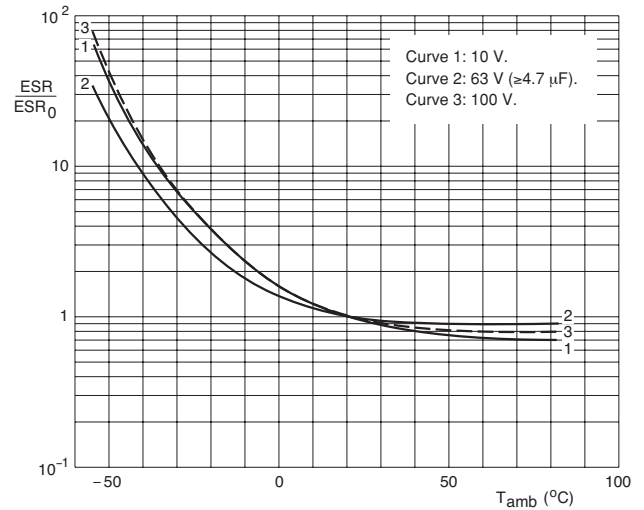

Case $\varnothing D \times L = 4.5 \times 10$ to 10×25 mm.

ESR_0 = typical ESR at 20 °C, 100 Hz.

Fig.9 Typical multiplier of ESR as a function of ambient temperature.

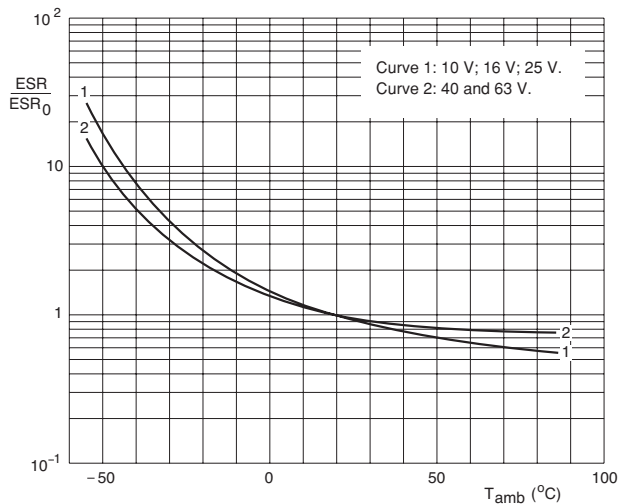

Case $\varnothing D \times L = 10 \times 30$, 12.5×30 and 15×30 mm.

ESR_0 = typical ESR at 20 °C, 100 Hz.

Fig.10 Typical multiplier of ESR as a function of ambient temperature.

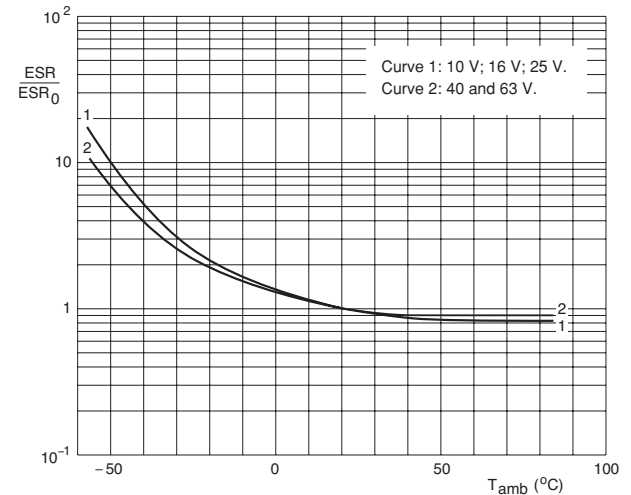

Case $\varnothing D \times L = 18 \times 30$, 18×38 and 21×38 mm.

ESR_0 = typical ESR at 20 °C, 100 Hz.

Fig.11 Typical multiplier of ESR as a function of ambient temperature.

EQUIVALENT SERIES RESISTANCE (ESR)

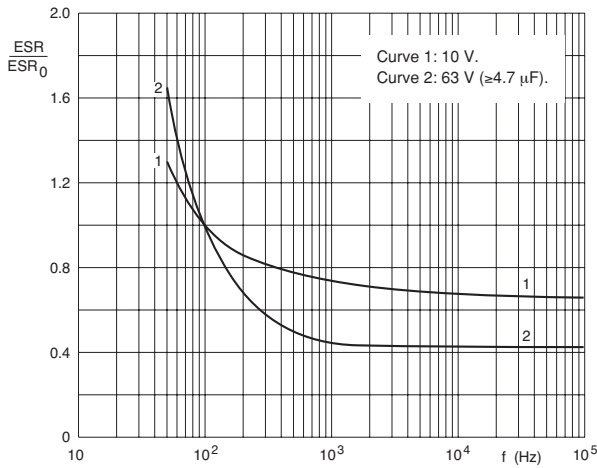

Case ØD x L = 4.5 x 10 to 10 x 25 mm.

ESR₀ = typical ESR at 20 °C, 100 Hz.

Fig.12 Typical multiplier of ESR as a function of frequency.

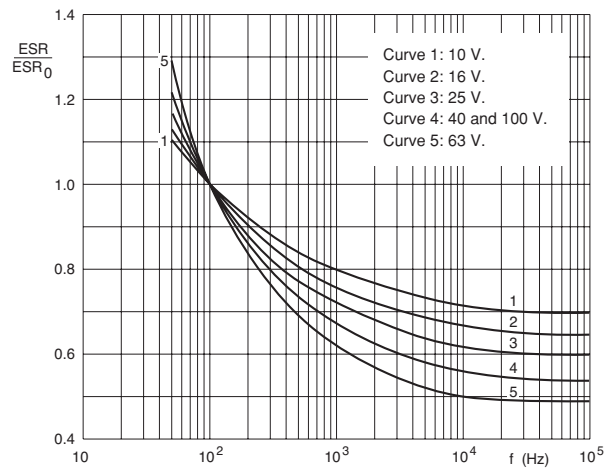

Case ØD x L = 10 x 30 to 21 x 38 mm.

ESR₀ = typical ESR at 20 °C, 100 Hz.

Fig.13 Typical multiplier of ESR as a function of frequency.

IMPEDANCE (Z)

Table 4

IMPEDANCE x CAPACITANCE VALUES (case ØD x L = 4.5 x 10 to 10 x 25 mm)							
T _{amb}	Z x C _R (Ω x µF) at 10 kHz						
	6.3 V	10 V	16 V	25 V	40 V	63 V	100 V
+20 °C	≤300	≤200	≤160	≤120	≤70	≤55	≤90
-25 °C	≤2000	≤1 200	≤750	≤560	≤300	≤180	≤600
-40 °C	≤5500	≤3200	≤2000	≤1 500	≤900	≤500	≤1 600

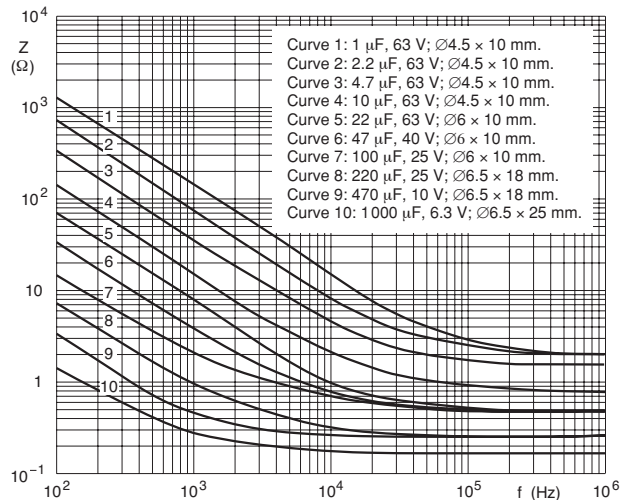

Case ØD x L = 4.5 x 10 to 6.5 x 25 mm.

Fig.14 Typical impedance as a function of frequency.

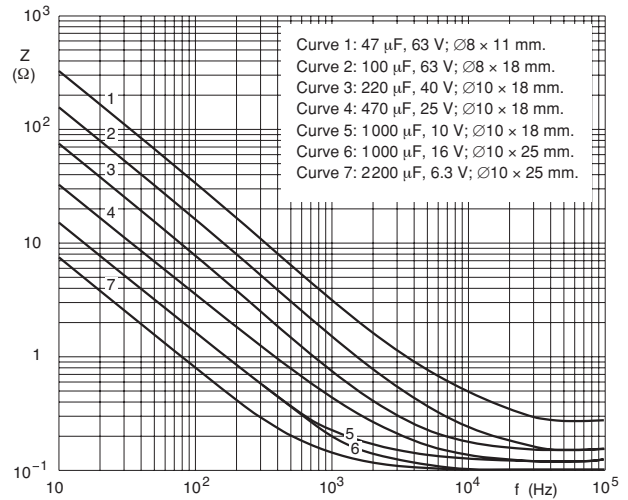

Case ØD x L = 8 x 11 to 10 x 25 mm.

Fig.15 Typical impedance as a function of frequency.

IMPEDANCE (Z)

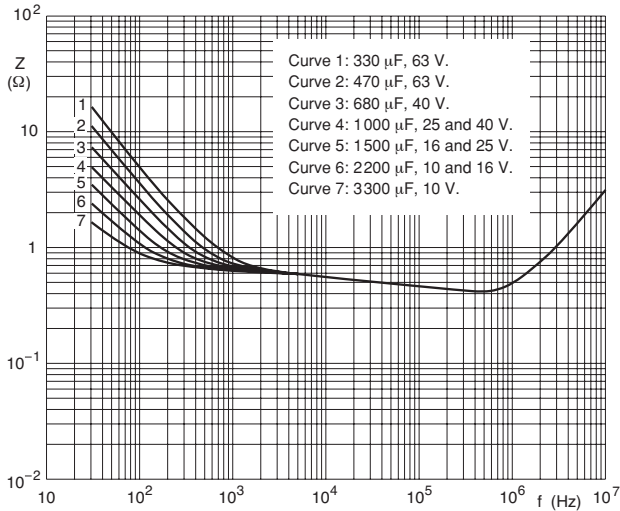

Case $\varnothing D \times L = 12.5 \times 30$ mm.

$T_{amb} = 40$ °C.

Fig.16 Typical impedance as a function of frequency.

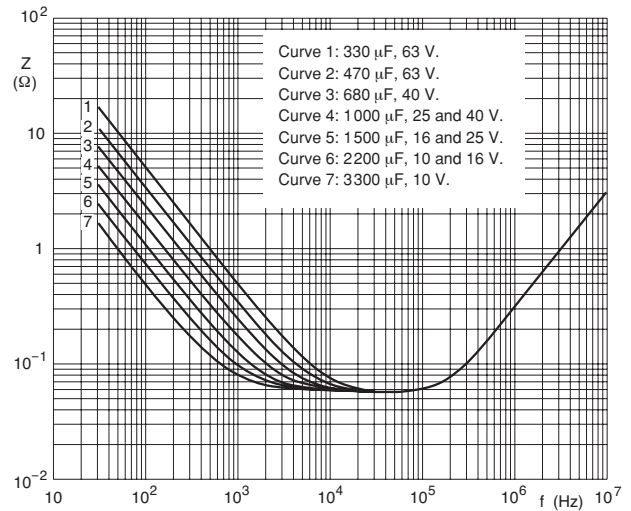

Case $\varnothing D \times L = 12.5 \times 30$ mm.

$T_{amb} = 20$ °C.

Fig.17 Typical impedance as a function of frequency.

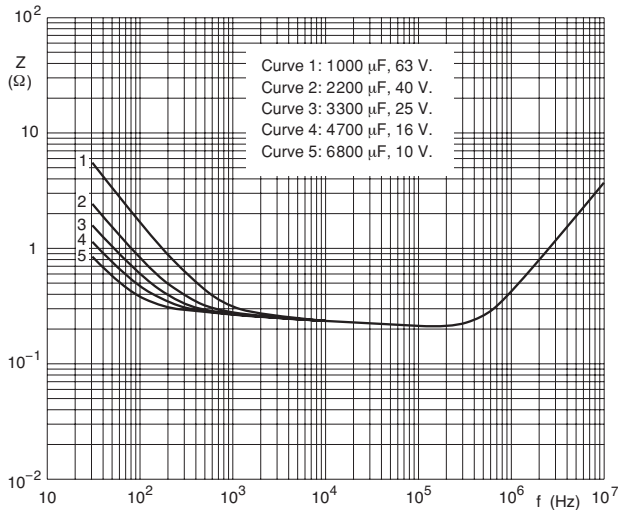

Case $\varnothing D \times L = 18 \times 30$ mm.

$T_{amb} = 40$ °C.

Fig.18 Typical impedance as a function of frequency.

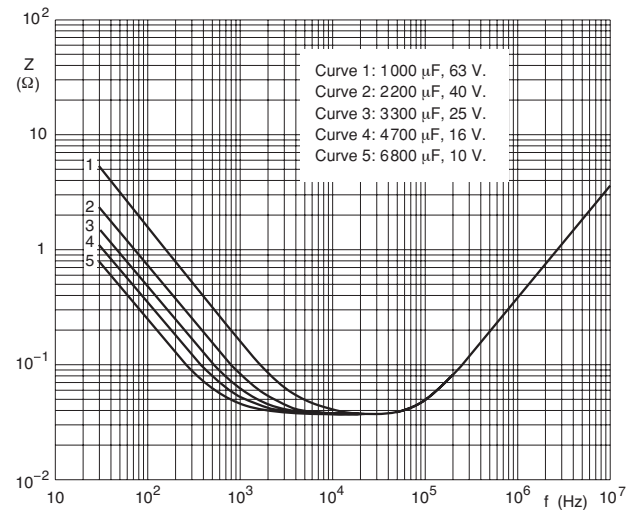

Case $\varnothing D \times L = 18 \times 30$ mm.

$T_{amb} = 20$ °C.

Fig.19 Typical impedance as a function of frequency.



RIPPLE CURRENT AND USEFUL LIFE

CCC205

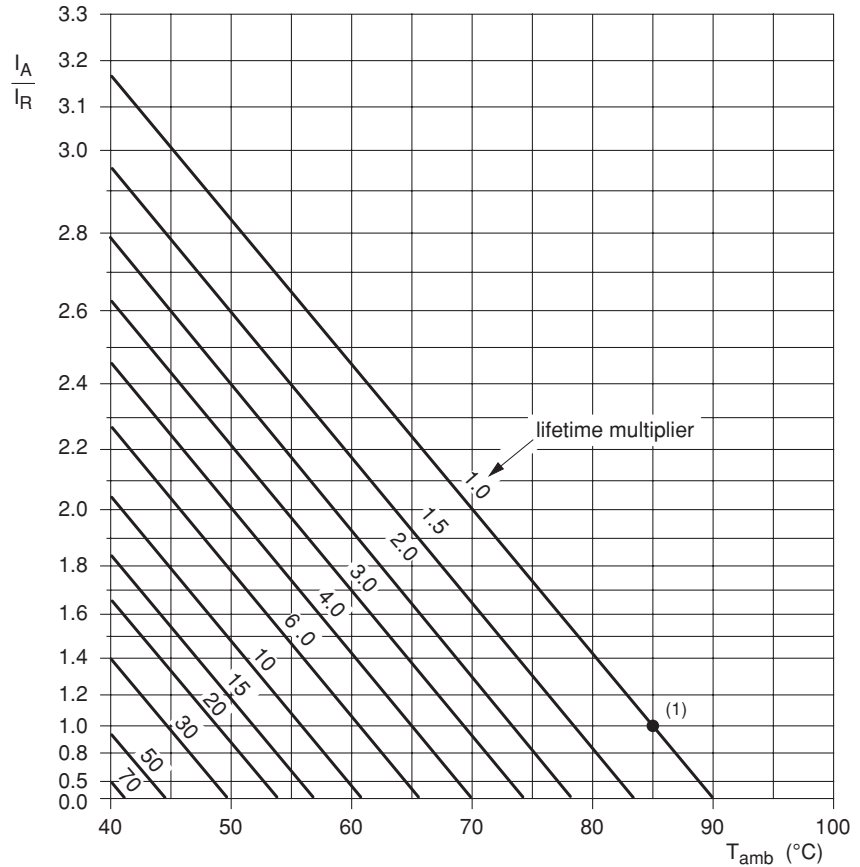

I_A = actual ripple current at 100 Hz.
 I_R = rated ripple current at 100 Hz, 85 °C.

(1) Useful life at 85 °C and I_R applied:
 case $\varnothing D \times L = 4.5 \times 10$ to 10×25 mm: 2500 hours
 case $\varnothing D \times L = 10 \times 30$ to 21×38 mm: 8000 hours.

Fig.20 Multiplier of useful life as a function of ambient temperature and ripple current load

Table 5

MULTIPLIER OF RIPPLE CURRENT (I_R) AS A FUNCTION OF FREQUENCY			
FREQUENCY (Hz)	I_R MULTIPLIER		
	$U_R = 6.3$ to 16 V	$U_R = 25$ to 40 V	$U_R = 63$ to 100 V
50	0.95	0.90	0.85
100	1.00	1.00	1.00
300	1.07	1.12	1.20
1000	1.12	1.20	1.30
3000	1.15	1.25	1.35
≥ 10000	1.20	1.30	1.40



Table 6

TEST PROCEDURES AND REQUIREMENTS			
TEST		PROCEDURE (quick reference)	REQUIREMENTS
NAME OF TEST	REFERENCE		
Endurance	IEC 60384-4/ EN130300 subclause 4.13	$T_{amb} = 85\text{ }^{\circ}\text{C}$; U_R applied; case $\varnothing D \times L = 4.5 \times 10$ to 10×25 mm: $U_R = 6.3$ to 25 V: 1000 hours; $U_R = 40$ to 100 V: 2000 hours; case $\varnothing D \times L = 10 \times 30$ to 21×38 mm: $U_R = 6.3$ to 100 V: 5000 hours	$U_R \leq 6.3$ V; $\Delta C/C$: +15/-30% $U_R > 6.3$ V; $\Delta C/C$: $\pm 15\%$ $\tan \delta \leq 1.3 \times$ spec. limit $Z \leq 2 \times$ spec. limit $I_{L5} \leq$ spec. limit
		$T_{amb} = 105\text{ }^{\circ}\text{C}$; U_R applied; case $\varnothing D \times L = 10 \times 30$ to 21×38 mm: 1500 hours	$\Delta C/C$: $\leq \pm 15\%$ $\tan \delta \leq 1.6 \times$ spec. limit $Z \leq 2 \times$ spec. limit $I_{L5} \leq$ spec. limit
Useful life	CECC 30301 subclause 1.8.1	$T_{amb} = 85\text{ }^{\circ}\text{C}$; U_R and I_R applied; case $\varnothing D \times L = 4.5 \times 10$ to 10×25 mm: 2500 hours; case $\varnothing D \times L = 10 \times 30$ to 21×38 mm: 8000 hours	$U_R \leq 6.3$ V; $\Delta C/C$: +45/-50% $U_R > 6.3$ V; $\Delta C/C$: $\pm 45\%$ $\tan \delta \leq 3 \times$ spec. limit $Z \leq 3 \times$ spec. limit $I_{L5} \leq$ spec. limit no short or open circuit total failure percentage: $\leq 1\%$
Shelf life (storage at high temperature)	IEC 60384-4/ EN130300 subclause 4.17	$T_{amb} = 85\text{ }^{\circ}\text{C}$; no voltage applied; 500 hours after test: U_R to be applied for 30 minutes, 24 to 48 hours before measurement	$\Delta C/C$, $\tan \delta$, Z : for requirements see 'Endurance test' above $I_{L5} \leq 2 \times$ spec. limit