

DATA SHEET

021 ASM
Aluminum electrolytic capacitors
Axial Standard Miniature

Product specification
Supersedes data of 12th June 2002
File under BCcomponents, BC01

2003 Feb 25

Aluminum electrolytic capacitors

Axial Standard Miniature

021 ASM

FEATURES

- Polarized aluminum electrolytic capacitors, non-solid electrolyte
- Axial leads, cylindrical aluminum case, insulated with a blue sleeve
- Mounting ring version not insulated
- Charge and discharge proof
- Taped versions up to case $\varnothing 15 \times 30$ mm available for automatic insertion
- Miniaturized, high CV-product per unit volume.

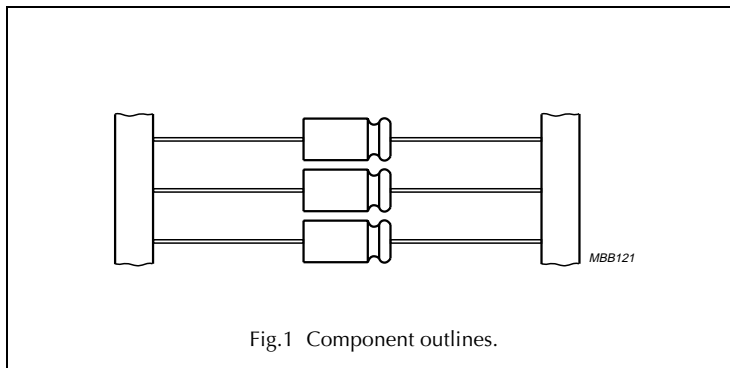
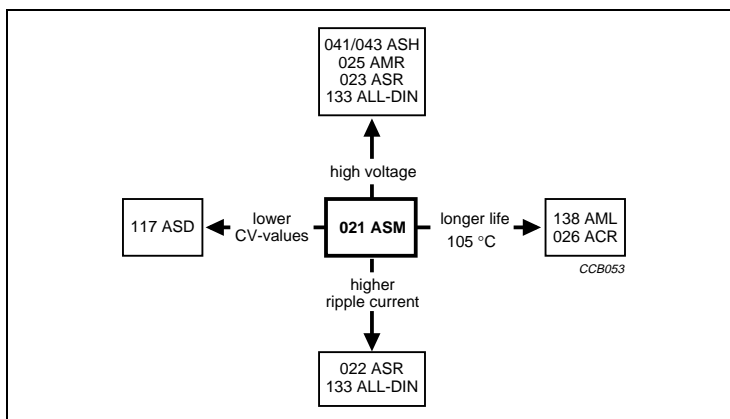

Fig.1 Component outlines.

APPLICATIONS

- General purpose, industrial, automotive, audio-video
- Coupling, decoupling, smoothing, filtering, buffering
- Portable and mobile equipment (small size, low mass)
- Low mounting height boards, vibration and shock resistant.



QUICK REFERENCE DATA

DESCRIPTION	VALUE	
Case sizes ($\varnothing D_{nom} \times L_{nom}$ in mm)	4.5 × 10 to 10 × 25	10 × 30 to 21 × 38
Rated capacitance range, C_R	0.47 to 15 000 μ F	
Tolerance on C_R	±20%	
Rated voltage range, U_R	6.3 to 100 V	
Category temperature range	-40 to +85 °C	
Endurance test at 85 °C:		
$U_R = 6.3$ to 25 V	1 000 hours	5 000 hours
$U_R = 40$ to 100 V	2 000 hours	5 000 hours
Endurance test at 105 °C	–	1 500 hours
Useful life at 85 °C	2 500 hours	8 000 hours
Useful life at 40 °C, $1.4 \times I_R$ applied	70 000 hours	200 000 hours
Shelf life at 0 V, 85 °C	500 hours	500 hours
Based on sectional specification	IEC 60384-4/EN130300	
Climatic category IEC 60068	40/085/56	

Aluminum electrolytic capacitors

Axial Standard Miniature

021 ASM
Selection chart for C_R , U_R and relevant nominal case sizes ($\varnothing D \times L$ in mm)

 Preferred types in **bold**.

C_R (μF)	U_R (V)						
	6.3	10	16	25	40	63	100
0.47	–	–	–	–	–	4.5 × 10	–
1	–	–	–	–	–	4.5 × 10	4.5 × 10
2.2	–	–	–	–	–	4.5 × 10	4.5 × 10
3.3	–	–	–	–	–	4.5 × 10	–
4.7	–	–	–	–	–	4.5 × 10	4.5 × 10
10	–	–	–	–	–	4.5 × 10	6 × 10
15	–	–	–	–	–	4.5 × 10	8 × 11
	–	–	–	–	–	–	6.5 × 18
22	–	–	–	–	4.5 × 10	6 × 10	8 × 11
	–	–	–	–	–	–	6.5 × 18
33	–	–	–	–	–	6 × 10	6.5 × 18
47	–	–	–	4.5 × 10	6 × 10	8 × 11	8 × 18
	–	–	–	–	–	6.5 × 18	–
68	–	–	4.5 × 10	–	–	8 × 11	10 × 18
	–	–	–	–	–	6.5 × 18	–
100	–	4.5 × 10	–	6 × 10	8 × 11	8 × 18	10 × 25
	–	–	–	–	6.5 × 18	–	10 × 30
150	–	–	6 × 10	8 × 11	8 × 18	10 × 18	12.5 × 30
	–	–	–	6.5 × 18	–	–	–
220	–	6 × 10	8 × 11	6.5 × 18	10 × 18	10 × 25	12.5 × 30
	–	–	–	–	–	10 × 30	–
330	–	8 × 11	6.5 × 18	8 × 18	10 × 25	12.5 × 30	15 × 30
470	8 × 11	6.5 × 18	8 × 18	10 × 18	10 × 25	12.5 × 30	18 × 30
	–	–	–	–	10 × 30	–	–
680	–	8 × 18	10 × 18	10 × 25	12.5 × 30	15 × 30	18 × 38
	–	–	–	10 × 30	–	–	–
1000	8 × 18	10 × 18	10 × 25	12.5 × 30	12.5 × 30	18 × 30	21 × 38
	–	–	10 × 30	–	–	–	–
1500	–	10 × 25	12.5 × 30	12.5 × 30	15 × 30	18 × 38	–
	–	10 × 30	–	–	–	–	–
2200	10 × 25	12.5 × 30	12.5 × 30	15 × 30	18 × 30	21 × 38	–
3300	–	12.5 × 30	15 × 30	18 × 30	18 × 38	–	–
4700	–	15 × 30	18 × 30	18 × 38	21 × 38	–	–
6800	–	18 × 30	18 × 38	21 × 38	–	–	–
10000	–	18 × 38	21 × 38	–	–	–	–
15000	–	21 × 38	–	–	–	–	–

Aluminum electrolytic capacitors

Axial Standard Miniature

021 ASM

MECHANICAL DATA, AVAILABLE FORMS AND PACKAGING QUANTITIES

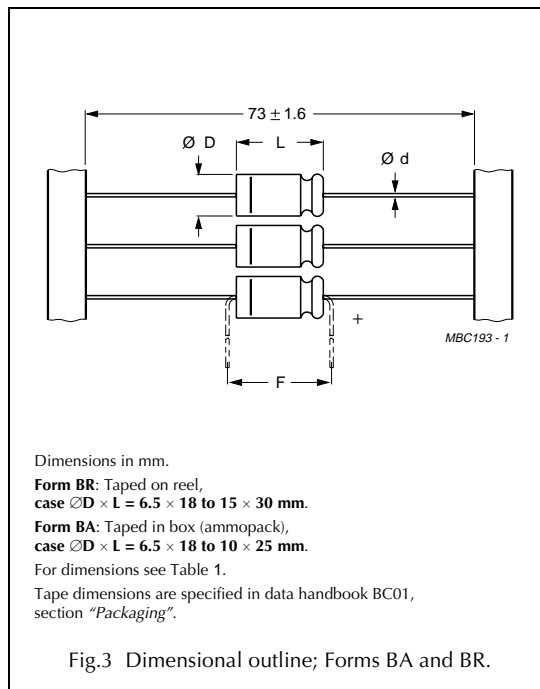
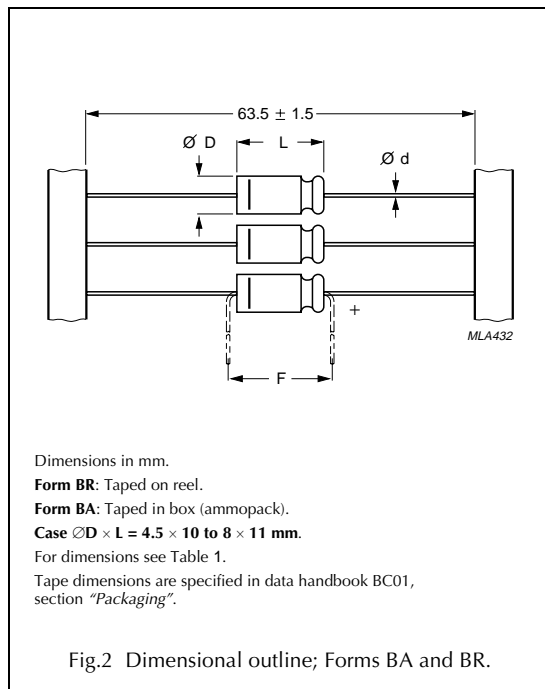

Table 1 Axial; physical dimensions, mass and packaging quantities; see Figs 2, 3 and 4

NOMINAL CASE SIZE $\varnothing D \times L$ (mm)	CASE CODE	AXIAL: FORM AA, BA, and BR					MASS (g)	PACKAGING QUANTITIES		
		$\varnothing d$	l	$\varnothing D_{max}$ (mm)	L_{max} (mm)	F_{min} (mm)		FORM AA	FORM BA	FORM BR
4.5 × 10	2	0.6	–	5.0	10.5	15	≈0.50	–	1000	3000
6 × 10	3	0.6	–	6.3	10.5	15	≈0.70	–	1000	1000
8 × 11	5a	0.6	–	8.5	11.5	15	≈1.1	–	500	500
6.5 × 18	4	0.8	–	6.9	18.5	25	≈1.3	–	1000	1000
8 × 18	5	0.8	–	8.5	18.5	25	≈1.7	–	500	500
10 × 18	6	0.8	–	10.5	18.5	25	≈2.5	–	500	500
10 × 25	7	0.8	–	10.5	25.0	30	≈3.3	–	500	500
10 × 30	00	0.8	55 ±1	10.5	30.5	35	≈4.8	340	–	500
12.5 × 30	01	0.8	55 ±1	13.0	30.5	35	≈7.4	260	–	400
15 × 30	02	0.8	55 ±1	15.5	30.5	35	≈11.7	300	–	250
18 × 30	03	0.8	55 ±1	18.5	30.5	35	≈12.9	200	–	–
18 × 38	04	0.8	34 ±1	18.5	39.0	44	≈19.0	125	–	–
21 × 38	05	0.8	34 ±1	21.5	39.0	44	≈24.0	100	–	–

Aluminum electrolytic capacitors

Axial Standard Miniature

021 ASM

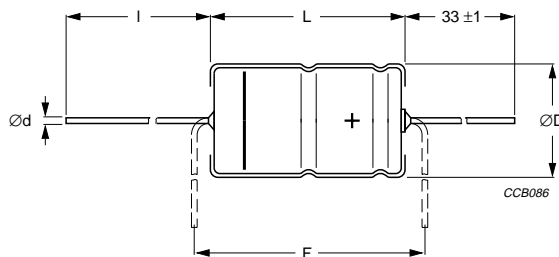

Dimensions in mm.

Form AA: Axial in box.

Case ØD × L = 10 × 30 to 21 × 38 mm.

For dimensions see Table 1.

Fig.4 Dimensional outline; Form AA.

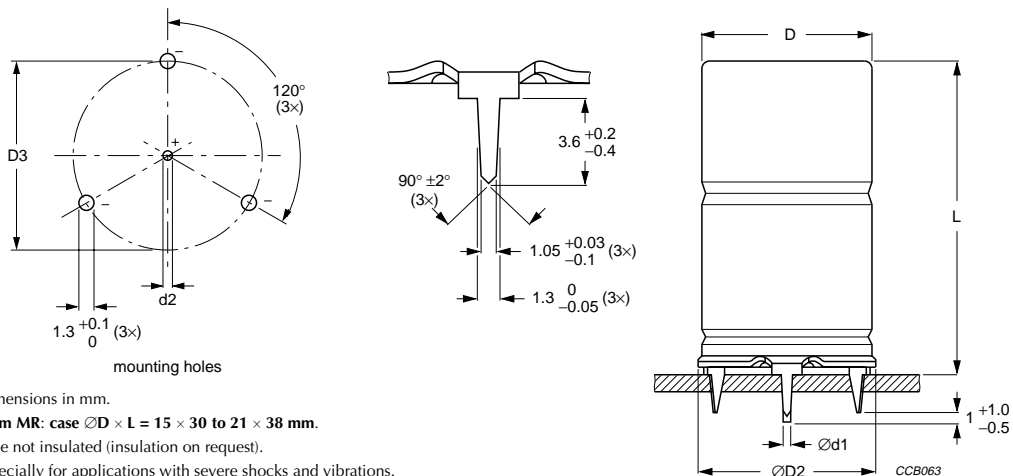

Dimensions in mm.

Form MR: case ØD × L = 15 × 30 to 21 × 38 mm.

Case not insulated (insulation on request).

Especially for applications with severe shocks and vibrations.

For dimensions see Table 2.

Fig.5 Mounting hole diagram and outline; Form MR; with mounting ring and pins.

Table 2 Mounting ring; mass and packaging quantities; see Fig.5

NOMINAL CASE SIZE ØD × L (mm)	CASE CODE	MOUNTING RING: FORM MR					MASS (g)	PACKAGING QUANTITIES
		Ød1 (mm)	Ød2 (mm)	ØD2 _{max} (mm)	D3 (mm)	L _{max} (mm)		
15 × 30	02	0.8	1.0 +0.4	17.5	16.5 ±0.2	33	≈11.7	200
18 × 30	03	0.8	1.0 +0.4	19.5	18.5 ±0.2	33	≈12.9	240
18 × 38	04	0.8	1.0 +0.4	19.5	18.5 ±0.2	42	≈19.0	100
21 × 38	05	0.8	1.0 +0.4	22.5	21.5 ±0.2	42	≈24.0	100

Aluminum electrolytic capacitors

Axial Standard Miniature

021 ASM

ELECTRICAL DATA AND ORDERING INFORMATION

Unless otherwise specified, all electrical values in Table 3 apply at $T_{amb} = 20\text{ °C}$, $P = 86$ to 106 kPa , $RH = 45$ to 75% .

SYMBOL	DESCRIPTION
C_R	rated capacitance at 100 Hz, tolerance $\pm 20\%$
I_R	rated RMS ripple current at 100 Hz, 85 °C
I_{L5}	max. leakage current after 5 minutes at U_R
$\tan \delta$	max. dissipation factor at 100 Hz
ESR	equivalent series resistance at 100 Hz (calculated from $\tan \delta_{max}$ and C_R)
Z	max. impedance at 10 kHz

Ordering example

Electrolytic capacitor 021 series

1000 $\mu\text{F}/16\text{ V}$; $\pm 20\%$

Nominal case size: $\varnothing 10 \times 25\text{ mm}$;
Form BA

Catalogue number: 2222 021 90518.

Table 3 Electrical data and ordering Information; preferred types in **bold**

U_R (V)	C_R 100 Hz (μF)	NOMINAL CASE SIZE $\varnothing D \times L$ (mm)	I_R 100 Hz 85 °C (mA)	I_{L5} 5 min (μA)	$\tan \delta$ 100 Hz	ESR 100 Hz (Ω)	Z 10 kHz (Ω)	CATALOGUE NUMBER 2222 021			
								IN BOX FORM AA	TAPED ON REEL FORM BR	TAPED IN BOX FORM BA	MOUNTING RING FORM MR
6.3	470	8 × 11	260	10	0.25	0.85	0.64	–	23471	33471	–
	1000	8 × 18	440	17	0.25	0.4	0.5	–	23102	33102	–
	2200	10 × 25	710	32	0.29	0.21	0.16	–	90588	90589	–
10	100	4.5 × 10	100	6	0.20	3.2	2.0	–	24101	34101	–
	220	6 × 10	160	8.4	0.20	1.5	0.91	–	24221	34221	–
	330	8 × 11	230	11	0.20	1.0	0.61	–	24331	34331	–
	470	6.5 × 18	310	13	0.20	0.68	0.43	–	24471	34471	–
	680	8 × 18	400	18	0.20	0.47	0.29	–	24681	34681	–
	1000	10 × 18	550	24	0.20	0.32	0.20	–	24102	34102	–
	1500	10 × 25	690	34	0.23	0.25	0.18	–	90524	90525	–
	1500	10 × 30	740	34	0.23	0.245	0.18	14152	24152	–	–
	2200	12.5 × 30	980	48	0.25	0.177	0.095	14222	24222	–	–
	3300	12.5 × 30	1090	70	0.27	0.128	0.095	14332	24332	–	–
	4700	15 × 30	1320	98	0.29	0.100	0.07	14472	24472	–	44472
	6800	18 × 30	1590	140	0.34	0.079	0.065	14682	–	–	44682
10000	18 × 38	2090	204	0.40	0.064	0.04	14103	–	–	44103	
15000	21 × 38	2250	304	0.50	0.054	0.035	14153	–	–	44153	
16	68	4.5 × 10	90	6.2	0.16	3.8	2.4	–	25689	35689	–
	150	6 × 10	140	8.8	0.16	1.7	1.1	–	25151	35151	–
	220	8 × 11	210	11	0.16	1.2	0.73	–	25221	35221	–
	330	6.5 × 18	290	15	0.16	0.77	0.48	–	25331	35331	–
	470	8 × 18	380	19	0.16	0.55	0.34	–	25471	35471	–
	680	10 × 18	500	26	0.16	0.38	0.24	–	25681	35681	–
	1000	10 × 25	660	36	0.16	0.26	0.18	–	90517	90518	–
	1000	10 × 30	700	36	0.16	0.260	0.175	15102	25102	–	–
	1500	12.5 × 30	950	52	0.19	0.205	0.095	15152	25152	–	–

Aluminum electrolytic capacitors

Axial Standard Miniature

021 ASM

U _R (V)	C _R 100 Hz (μF)	NOMINAL CASE SIZE ØD × L (mm)	I _R 100 Hz 85 °C (mA)	I _{L5} 5 min (μA)	Tan δ 100 Hz	ESR 100 Hz (Ω)	Z 10 kHz (Ω)	CATALOGUE NUMBER 2222 021			
								IN BOX FORM AA	TAPED ON REEL FORM BR	TAPED IN BOX FORM BA	MOUNTING RING FORM MR
16	2200	12.5 × 30	1040	74	0.21	0.150	0.095	15222	25222	–	–
	3300	15 × 30	1290	110	0.23	0.111	0.07	15332	25332	–	45332
	4700	18 × 30	1560	154	0.25	0.087	0.065	15472	–	–	45472
	6800	18 × 38	2040	222	0.30	0.070	0.04	15682	–	–	45682
	10000	21 × 38	2170	324	0.36	0.058	0.035	15103	–	–	45103
25	47	4.5 × 10	80	6.4	0.14	4.8	2.6	–	26479	36479	–
	100	6 × 10	150	9	0.14	2.3	1.2	–	26101	36101	–
	150	8 × 11	190	12	0.14	1.5	0.80	–	90534	90535	–
	150	6.5 × 18	210	12	0.14	1.5	0.80	–	26151	36151	–
	220	6.5 × 18	250	15	0.14	1.0	0.55	–	26221	36221	–
	330	8 × 18	340	21	0.14	0.68	0.36	–	26331	36331	–
	470	10 × 18	450	28	0.14	0.48	0.26	–	26471	36471	–
	680	10 × 25	560	38	0.14	0.33	0.18	–	90527	90528	–
	680	10 × 30	640	38	0.14	0.323	0.175	16681	26681	–	–
	1000	12.5 × 30	840	54	0.14	0.220	0.095	16102	26102	–	–
	1500	12.5 × 30	950	79	0.17	0.179	0.095	16152	26152	–	–
	2200	15 × 30	1180	114	0.19	0.132	0.07	16222	26222	–	46222
	3300	18 × 30	1470	169	0.21	0.099	0.065	16332	–	–	46332
	4700	18 × 38	1920	239	0.23	0.079	0.04	16472	–	–	46472
6800	21 × 38	2070	344	0.28	0.064	0.035	16682	–	–	46682	
40	22	4.5 × 10	60	5.8	0.11	8.0	3.2	–	27229	37229	–
	47	6 × 10	110	7.8	0.11	3.8	1.5	–	27479	37479	–
	100	8 × 11	170	12	0.11	1.8	0.70	–	90537	90538	–
	100	6.5 × 18	190	12	0.11	1.8	0.70	–	27101	37101	–
	150	8 × 18	250	16	0.11	1.1	0.47	–	27151	37151	–
	220	10 × 18	330	22	0.11	0.8	0.32	–	27221	37221	–
	330	10 × 25	430	30	0.11	0.53	0.21	–	27331	37331	–
	470	10 × 25	520	42	0.11	0.37	0.18	–	90514	90515	–
	470	10 × 30	590	42	0.12	0.404	0.175	17471	27471	–	–
	680	12.5 × 30	800	58	0.12	0.297	0.110	17681	27681	–	–
	1000	12.5 × 30	900	84	0.12	0.190	0.110	17102	27102	–	–
	1500	15 × 30	1120	124	0.15	0.159	0.07	17152	27152	–	47152
	2200	18 × 30	1390	180	0.17	0.118	0.065	17222	–	–	47222
	3300	18 × 38	1810	268	0.19	0.090	0.04	17332	–	–	47332
4700	21 × 38	1940	380	0.21	0.072	0.035	17472	–	–	47472	
63	0.47	4.5 × 10	8	4.1	0.09	310	120	–	28477	38477	–
	1	4.5 × 10	12	4.1	0.09	150	55	–	28108	38108	–
	2.2	4.5 × 10	21	4.3	0.09	65	25	–	28228	38228	–
	3.3	4.5 × 10	25	4.4	0.09	44	17	–	28338	38338	–
	4.7	4.5 × 10	31	4.6	0.09	31	12	–	28478	38478	–

Aluminum electrolytic capacitors

Axial Standard Miniature

021 ASM

U _R (V)	C _R 100 Hz (μF)	NOMINAL CASE SIZE ∅D × L (mm)	I _R 100 Hz 85 °C (mA)	I _{L5} 5 min (μA)	Tan δ 100 Hz	ESR 100 Hz (Ω)	Z 10 kHz (Ω)	CATALOGUE NUMBER 2222 021			
								IN BOX FORM AA	TAPED ON REEL FORM BR	TAPED IN BOX FORM BA	MOUNTING RING FORM MR
63	10	4.5 × 10	50	5.3	0.08	13	5.5	–	28109	38109	–
	15	4.5 × 10	55	5.9	0.08	8.5	3.7	–	28159	38159	–
	22	6 × 10	90	6.8	0.08	5.8	2.5	–	28229	38229	–
	33	6 × 10	100	8.2	0.08	3.9	1.7	–	28339	38339	–
	47	8 × 11	140	10	0.08	2.7	1.2	–	90541	90542	–
	47	6.5 × 18	150	10	0.08	2.7	1.2	–	28479	38479	–
	68	8 × 11	160	13	0.08	1.9	0.81	–	90544	90545	–
	68	6.5 × 18	170	13	0.08	1.9	0.81	–	28689	38689	–
	100	8 × 18	250	17	0.08	1.3	0.55	–	28101	38101	–
	150	10 × 18	320	23	0.08	0.85	0.37	–	28151	38151	–
	220	10 × 25	430	32	0.08	0.60	0.25	–	90511	90512	–
	220	10 × 30	480	32	0.08	0.614	0.26	18221	28221	–	–
	330	12.5 × 30	610	46	0.08	0.409	0.19	18331	28331	–	–
	470	12.5 × 30	700	63	0.08	0.287	0.13	18471	28471	–	–
	680	15 × 30	890	90	0.08	0.199	0.095	18681	28681	–	48681
	1000	18 × 30	1170	130	0.08	0.135	0.075	18102	–	–	48102
	1500	18 × 38	1530	193	0.11	0.122	0.045	18152	–	–	48152
	2200	21 × 38	1780	281	0.13	0.099	0.040	18222	–	–	48222
	100	1	4.5 × 10	14	4.2	0.08	130	90	–	29108	39108
2.2		4.5 × 10	20	4.4	0.08	58	41	–	29228	39228	–
4.7		4.5 × 10	30	4.9	0.08	27	19	–	29478	39478	–
10		6 × 10	65	6	0.08	13	9	–	29109	39109	–
15		8 × 11	77	7	0.08	8.5	6	–	90547	90548	–
15		6.5 × 18	85	7	0.08	8.5	6	–	29159	39159	–
22		8 × 11	95	8.4	0.08	5.8	4.1	–	90551	90552	–
22		6.5 × 18	100	8.4	0.08	5.8	4.1	–	29229	39229	–
33		6.5 × 18	120	10.6	0.08	3.9	2.7	–	29339	39339	–
47		8 × 18	160	13.4	0.08	2.7	1.9	–	29479	39479	–
68		10 × 18	220	17.6	0.08	1.9	1.3	–	29689	39689	–
100		10 × 25	300	24	0.08	1.3	0.9	–	90531	90532	–
100		10 × 30	340	24	0.07	1.150	1.0	19101	29101	–	–
150		12.5 × 30	490	34	0.07	0.645	0.61	19151	29151	–	–
220		12.5 × 30	560	48	0.08	0.610	0.56	19221	29221	–	–
330		15 × 30	740	70	0.09	0.420	0.40	19331	29331	–	49331
470		18 × 30	980	98	0.09	0.310	0.29	19471	–	–	49471
680		18 × 38	1260	140	0.09	0.195	0.18	19681	–	–	49681
1000		21 × 38	1470	204	0.10	0.160	0.15	19102	–	–	49102

Aluminum electrolytic capacitors

Axial Standard Miniature

021 ASM**Additional electrical data**

PARAMETER	CONDITIONS	VALUE	
		AXIAL	MOUNTING RING
Voltage			
Surge voltage		$U_s \leq 1.15 \times U_R$	
Reverse voltage		$U_{rev} \leq 1 \text{ V}$	
Current			
Leakage current	after 1 minute at U_R	$I_{L1} \leq 0.006C_R \times U_R + 4 \mu\text{A}$	
	after 5 minutes at U_R :	$I_{L5} \leq 0.002C_R \times U_R + 4 \mu\text{A}$	
Inductance			
Equivalent series inductance (ESL)	case $\varnothing D \times L$ mm:		
	4.5 × 10	typ. 10 nH	–
	6 × 10	typ. 22 nH	–
	8 × 11	typ. 85 nH	–
	6.5 × 18	typ. 25 nH	–
	8 × 18	typ. 40 nH	–
	10 × 18	typ. 61 nH	–
	10 × 25	typ. 38 nH	–
	10 × 30	typ. 38 nH	–
	12.5 × 30	typ. 46 nH	–
	15 × 30	typ. 48 nH	typ. 39 nH
	18 × 30	typ. 50 nH	typ. 39 nH
	18 × 38	typ. 54 nH	typ. 39 nH
21 × 38	typ. 59 nH	typ. 39 nH	

Aluminum electrolytic capacitors

Axial Standard Miniature

021 ASM

Capacitance (C)

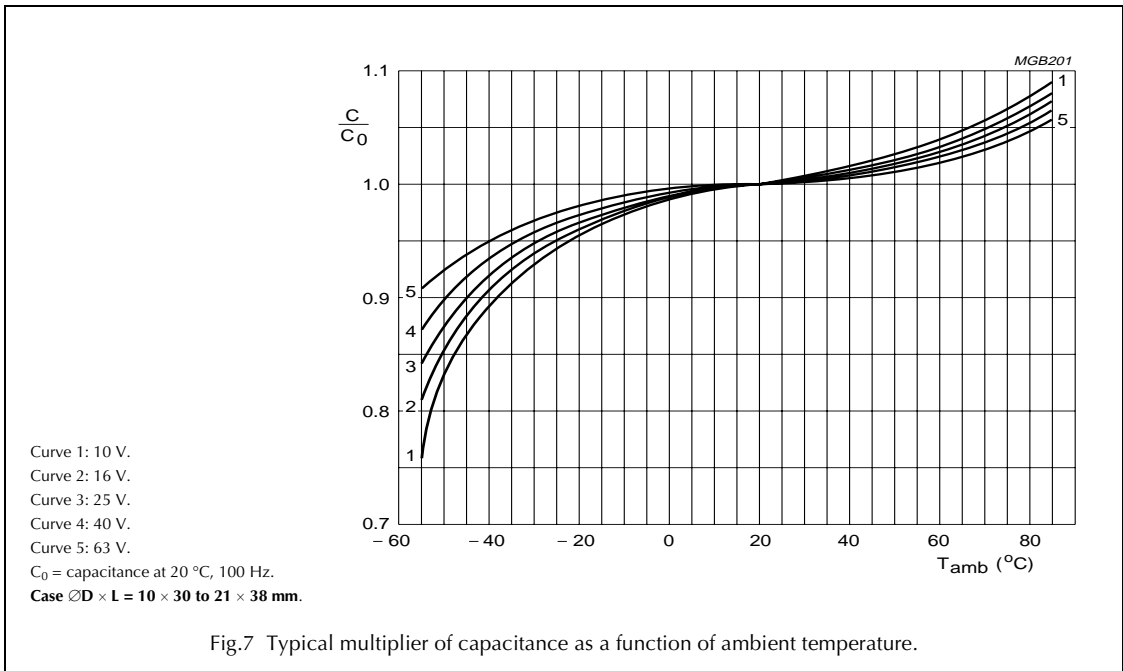
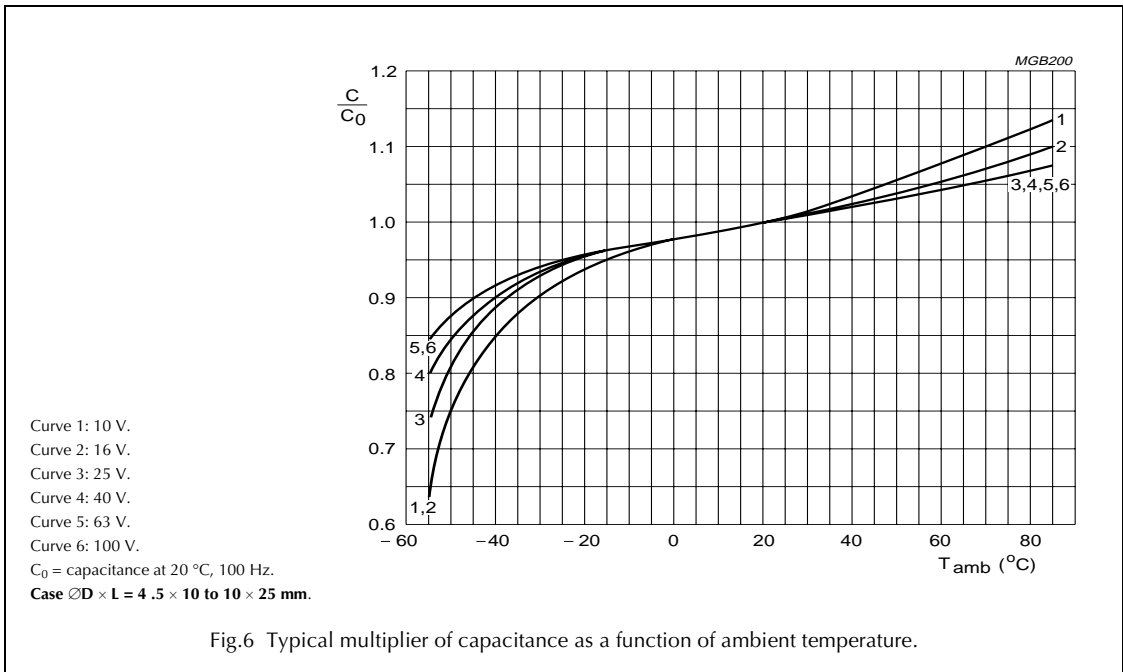

Aluminum electrolytic capacitors

Axial Standard Miniature

021 ASM

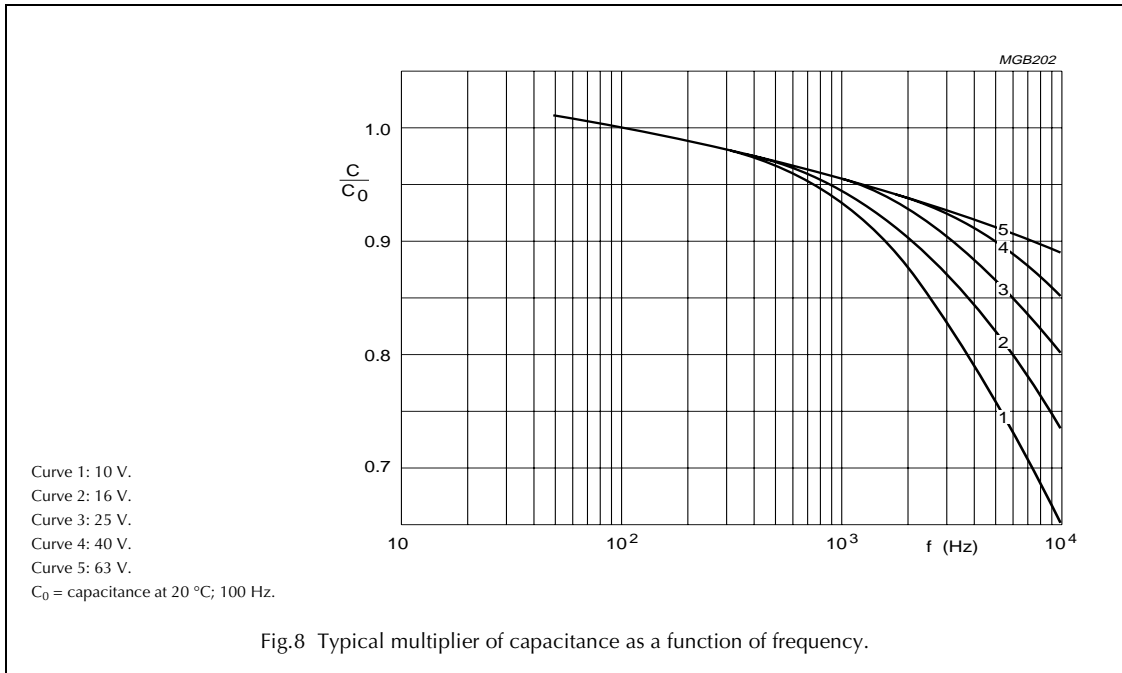

Equivalent series resistance (ESR)

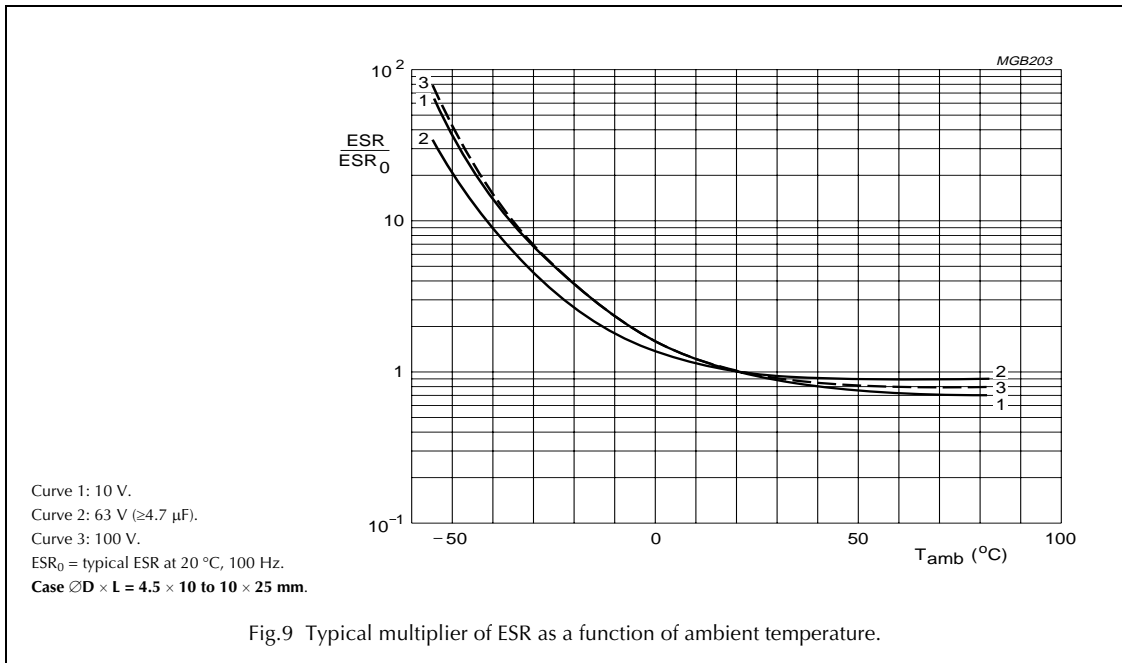

Aluminum electrolytic capacitors

Axial Standard Miniature

021 ASM

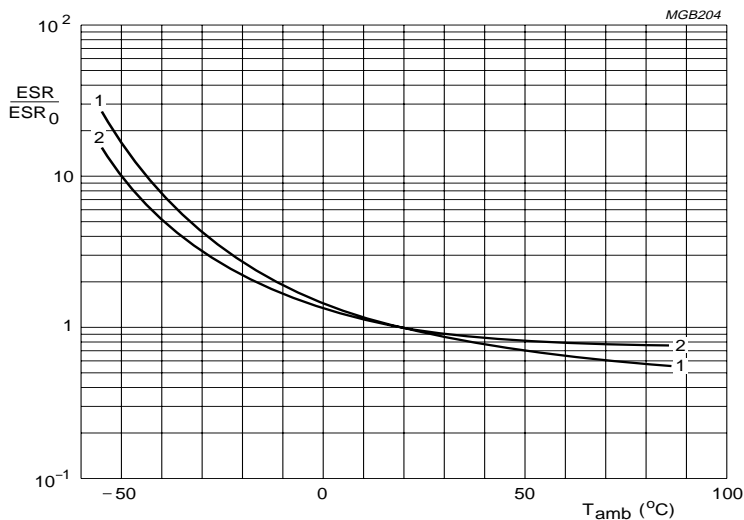

Curve 1: 10 V; 16 V; 25 V.

Curve 2: 40 and 63 V.

ESR₀ = typical ESR at 20 °C, 100 Hz.

Case $\varnothing D \times L = 10 \times 30, 12.5 \times 30$ and 15×30 mm.

Fig.10 Typical multiplier of ESR as a function of ambient temperature.

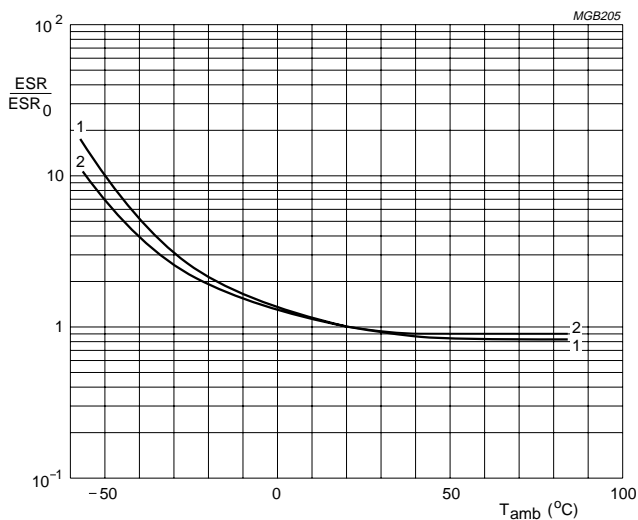

Curve 1: 10 V; 16 V; 25 V.

Curve 2: 40 and 63 V.

ESR₀ = typical ESR at 20 °C, 100 Hz.

Case $\varnothing D \times L = 18 \times 30, 18 \times 38$ and 21×38 mm.

Fig.11 Typical multiplier of ESR as a function of ambient temperature.

Aluminum electrolytic capacitors

Axial Standard Miniature

021 ASM

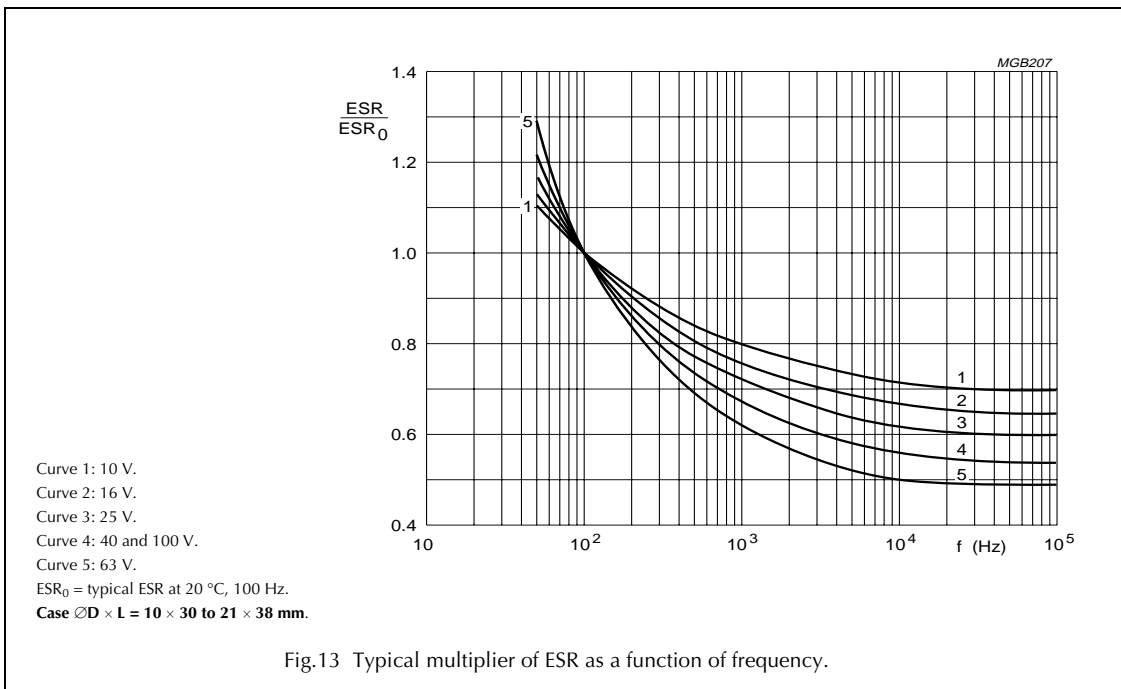
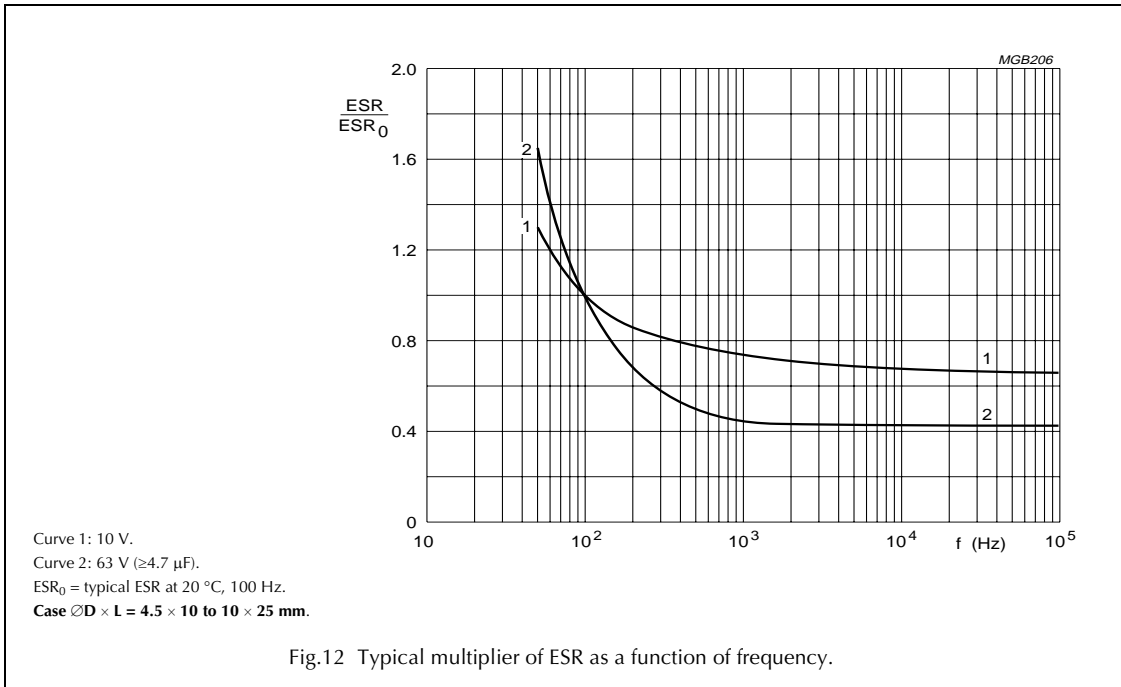

Aluminum electrolytic capacitors

Axial Standard Miniature

021 ASM

Impedance (Z)

Table 4 Impedance × capacitance values (case $\varnothing D \times L = 4.5 \times 10$ to 10×25 mm)

T_{amb}	$Z \times C_R (\Omega \times \mu F)$ at 10 kHz						
	6.3 V	10 V	16 V	25 V	40 V	63 V	100 V
+20 °C	≤300	≤200	≤160	≤120	≤70	≤55	≤90
-25 °C	≤2000	≤1200	≤750	≤560	≤300	≤180	≤600
-40 °C	≤5500	≤3200	≤2000	≤1500	≤900	≤500	≤1600

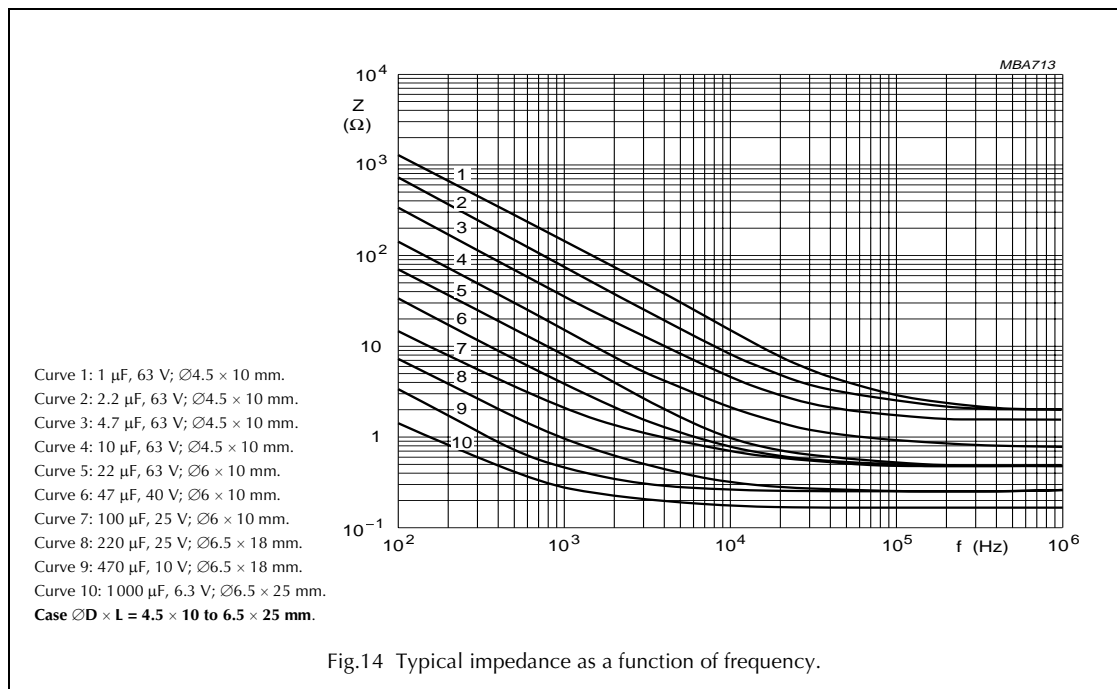

Aluminum electrolytic capacitors

Axial Standard Miniature

021 ASM

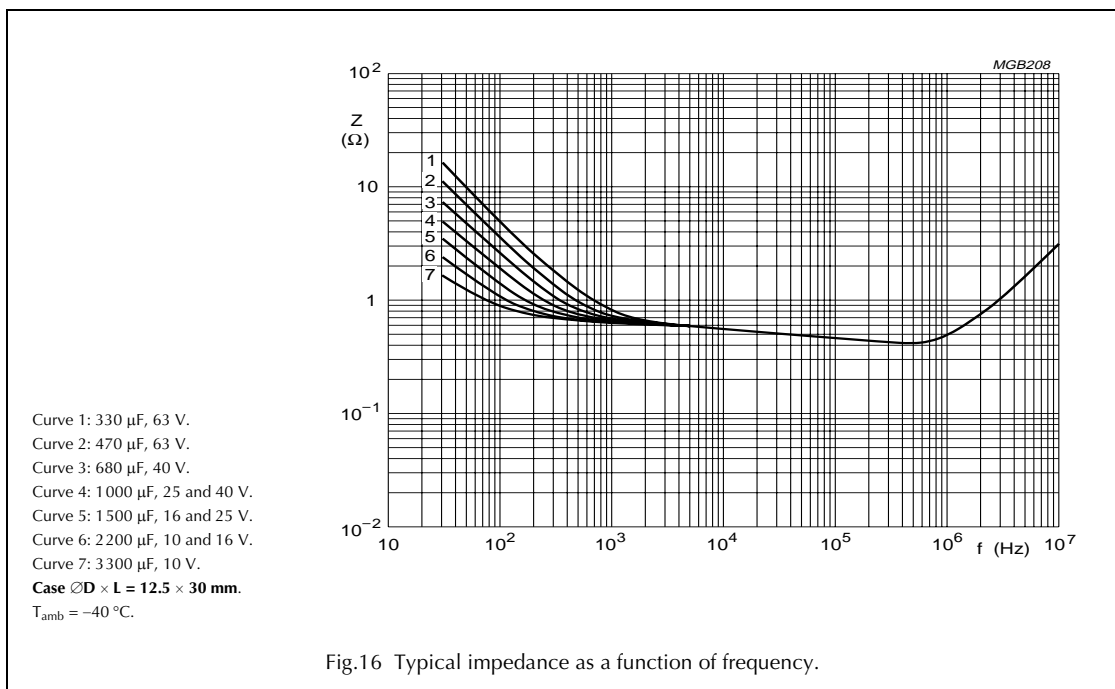
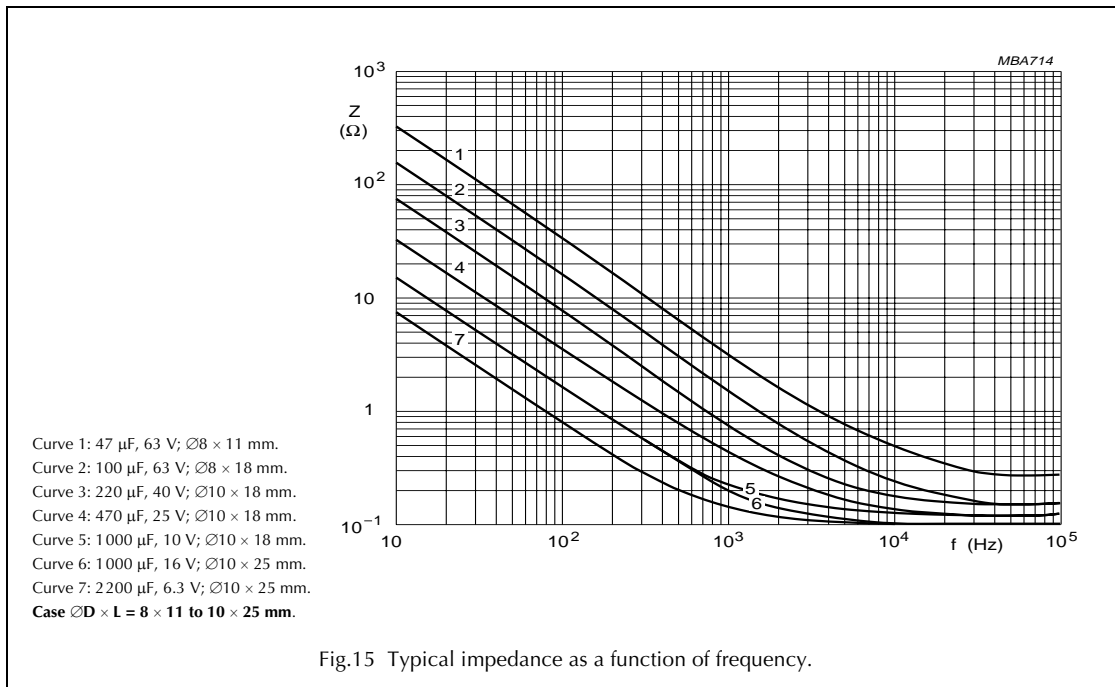

Aluminum electrolytic capacitors

Axial Standard Miniature

021 ASM

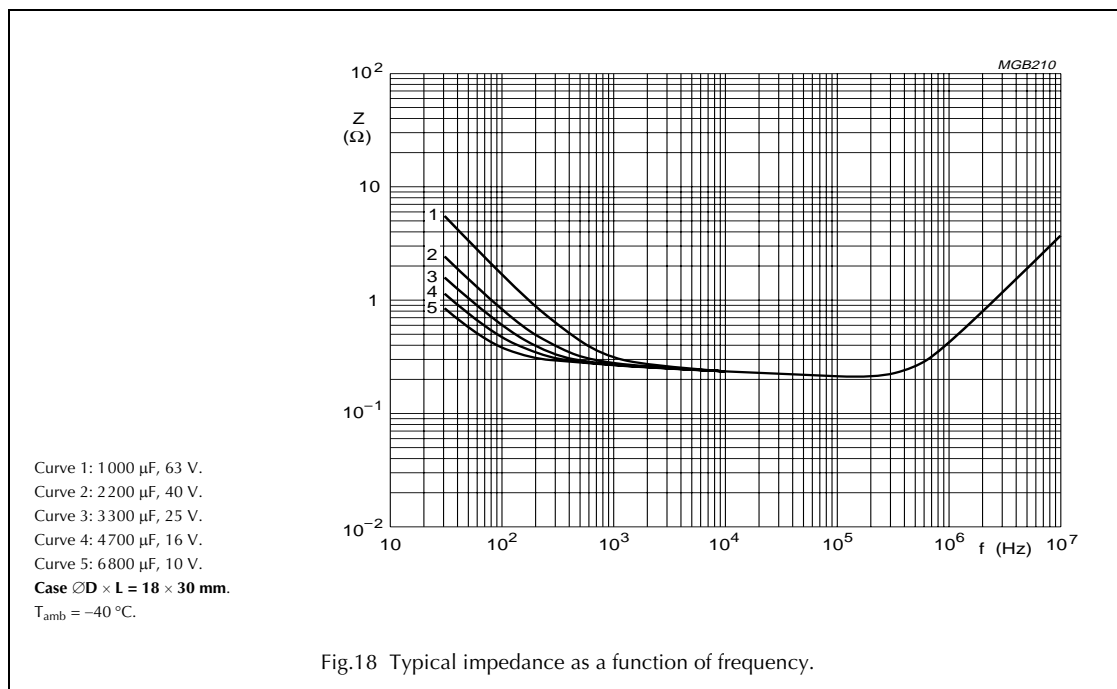
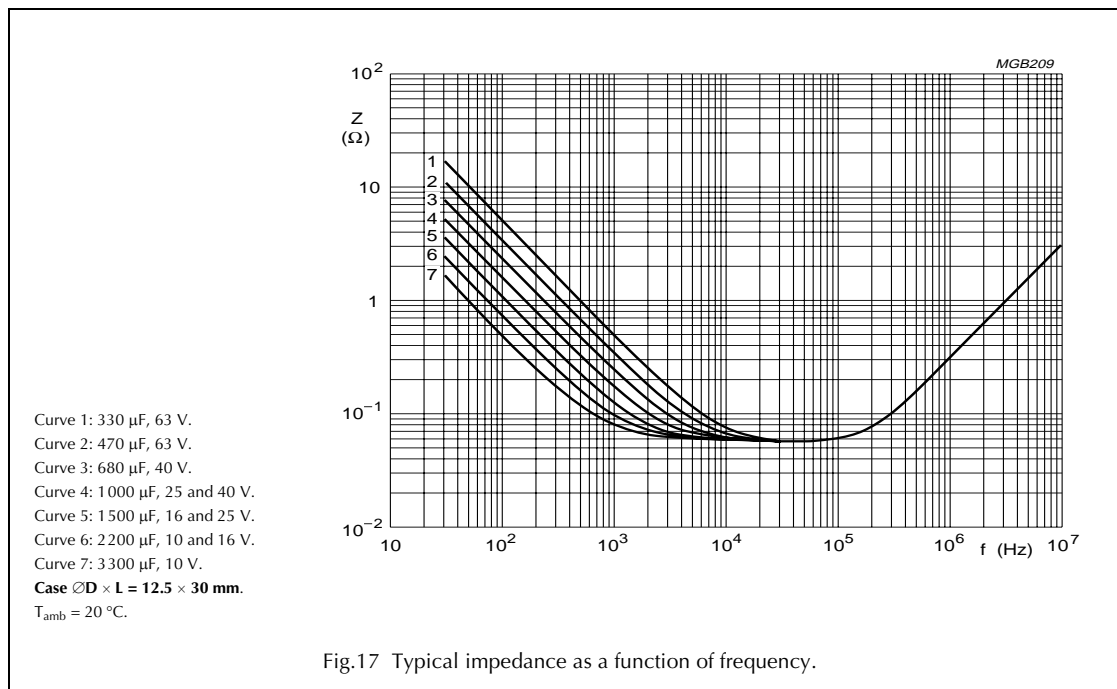

Aluminum electrolytic capacitors

Axial Standard Miniature

021 ASM

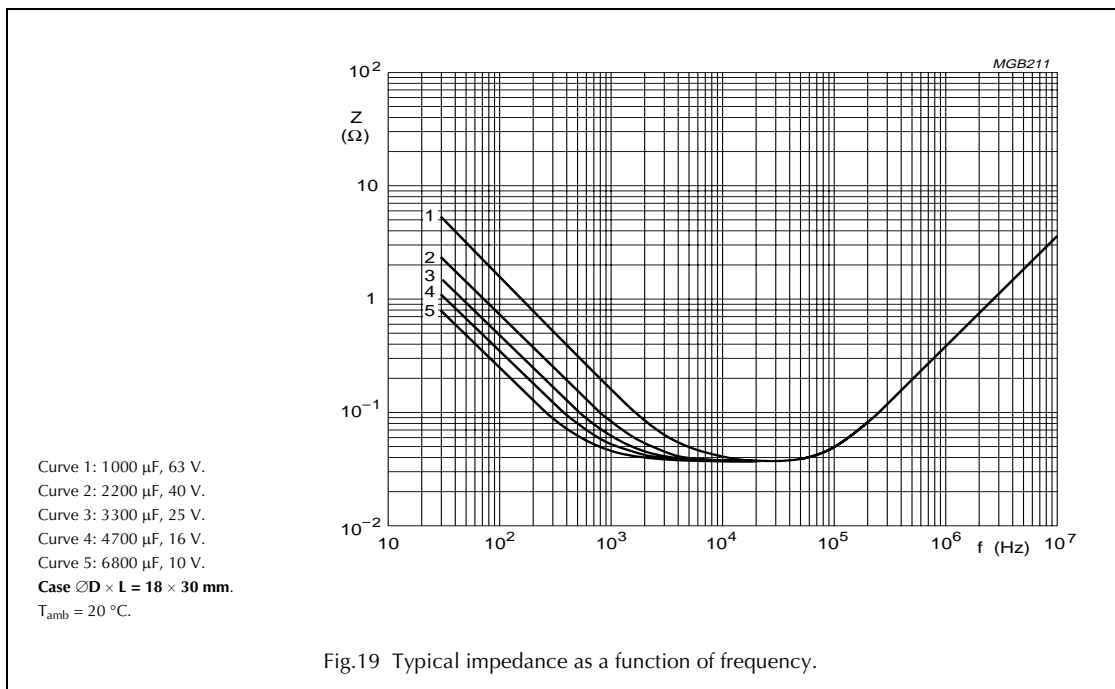

MARKING

The capacitors are marked (where possible) with the following information:

- Rated capacitance (in μF)
- Tolerance on nominal capacitance (in accordance with "IEC 60062")
- Rated voltage (in V)
- Group number (021)
- Name of manufacturer
- Date code in accordance with "IEC 60062"
- Code for factory of origin
- Band to indicate the negative terminal
- '+' sign to identify the positive terminal (not for case sizes $L < 18 \text{ mm}$).

Aluminum electrolytic capacitors

Axial Standard Miniature

021 ASM

RIPPLE CURRENT AND USEFUL LIFE

Table 5 Multiplier of ripple current (I_R) as a function of frequency

FREQUENCY (Hz)	I_R MULTIPLIER		
	$U_R = 6.3$ to 16 V	$U_R = 25$ to 40 V	$U_R = 63$ to 100 V
50	0.95	0.9	0.85
100	1	1	1
300	1.07	1.12	1.2
1000	1.12	1.2	1.3
3000	1.15	1.25	1.35
≥ 10000	1.2	1.3	1.4

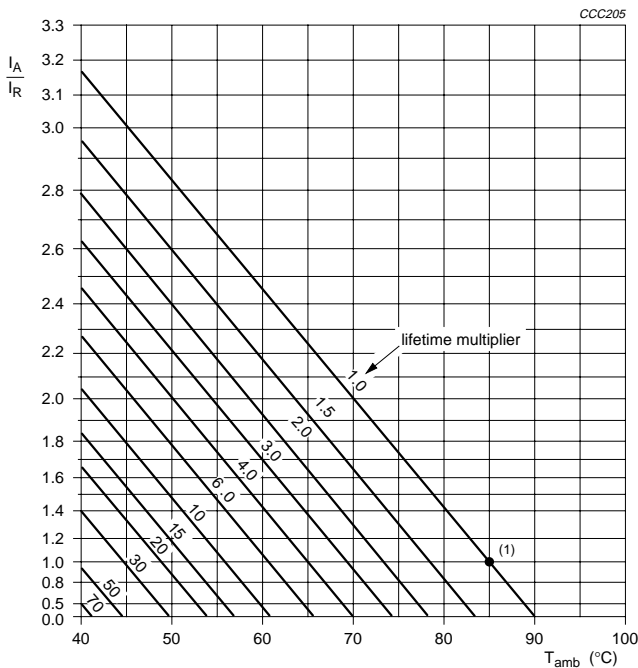

I_A = actual ripple current at 100 Hz.

I_R = rated ripple current at 100 Hz, 85 °C.

(1) Useful life at 85 °C and I_R applied:

case $\varnothing D \times L = 4.5 \times 10$ to 10×25 mm: 2500 hours

case $\varnothing D \times L = 10 \times 30$ to 21×38 mm: 8000 hours.

Fig.20 Multiplier of useful life as a function of ambient temperature and ripple current load.

Aluminum electrolytic capacitors

Axial Standard Miniature

021 ASM

SPECIFIC TESTS AND REQUIREMENTS

General tests and requirements are specified in data handbook BC01, section "Tests and Requirements".

Table 6 Test procedures and requirements

TEST		PROCEDURE (quick reference)	REQUIREMENTS
NAME OF TEST	REFERENCE		
Endurance	IEC 60384-4/ EN130300 subclause 4.13	$T_{amb} = 85\text{ °C}$; U_R applied; case $\varnothing D \times L = 4.5 \times 10$ to 10×25 mm: $U_R = 6.3$ to 25 V: 1000 hours; $U_R = 40$ to 100 V: 2000 hours; case $\varnothing D \times L = 10 \times 30$ to 21×38 mm: $U_R = 6.3$ to 100 V: 5000 hours	$U_R \leq 6.3$ V; $\Delta C/C$: +15/-30% $U_R > 6.3$ V; $\Delta C/C$: $\pm 15\%$ $\tan \delta \leq 1.3 \times \text{spec. limit}$ $Z \leq 2 \times \text{spec. limit}$ $I_{L5} \leq \text{spec. limit}$
		$T_{amb} = 105\text{ °C}$; U_R applied; case $\varnothing D \times L = 10 \times 30$ to 21×38 mm: 1500 hours	$\Delta C/C$: $\leq \pm 15\%$ $\tan \delta \leq 1.6 \times \text{spec. limit}$ $Z \leq 2 \times \text{spec. limit}$ $I_{L5} \leq \text{spec. limit}$
Useful life	CECC 30301 subclause 1.8.1	$T_{amb} = 85\text{ °C}$; U_R and I_R applied; case $\varnothing D \times L = 4.5 \times 10$ to 10×25 mm: 2500 hours; case $\varnothing D \times L = 10 \times 30$ to 21×38 mm: 8000 hours	$U_R \leq 6.3$ V; $\Delta C/C$: +45/-50% $U_R > 6.3$ V; $\Delta C/C$: $\pm 45\%$ $\tan \delta \leq 3 \times \text{spec. limit}$ $Z \leq 3 \times \text{spec. limit}$ $I_{L5} \leq \text{spec. limit}$ no short or open circuit total failure percentage: $\leq 1\%$
Shelf life (storage at high temperature)	IEC 60384-4/ EN130300 subclause 4.17	$T_{amb} = 85\text{ °C}$; no voltage applied; 500 hours after test: U_R to be applied for 30 minutes, 24 to 48 hours before measurement	$\Delta C/C$, $\tan \delta$, Z : for requirements see 'Endurance test' above $I_{L5} \leq 2 \times \text{spec. limit}$