

# Aluminum Capacitors

## Power Standard Miniature Snap-in

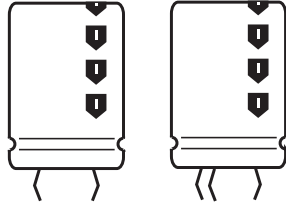
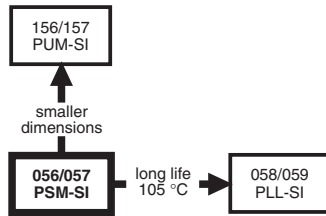

Fig.1 Component outlines.

**FEATURES**

- Polarized aluminum electrolytic capacitors, non-solid electrolyte
- Large types, minimized dimensions, cylindrical aluminum case, insulated with a blue sleeve
- Pressure relief on the top of the aluminum case
- Charge and discharge proof
- Long useful life: 12000 hours at 85 °C
- High ripple current capability
- Keyed polarity version available
- Lead (Pb)-free versions are RoHS compliant.

**RoHS\***  
COMPLIANT

**APPLICATIONS**

- General purpose, industrial and audio/video systems
- Smoothing and filtering
- Standard and switched mode power supplies
- Energy storage in pulse systems.

**MARKING**

The capacitors are marked (where possible) with the following information:

- Rated capacitance (in  $\mu\text{F}$ ).
- Tolerance code on rated capacitance, code letter in accordance with IEC 60062 (M for  $\pm 20\%$ ).
- Rated voltage (in V).
- Date code (YYMM).
- Name of manufacturer.
- Code for factory of origin.
- ‘-’ sign to identify the negative terminal, visible from the top and side of the capacitor.
- Code number.
- Climatic category in accordance with IEC 60068.

**QUICK REFERENCE DATA**

DESCRIPTION	VALUE	
	056	057
Nominal case size ( $\varnothing D \times L$ in mm)	22 × 25 to 35 × 50	
Rated capacitance range (E6 series), $C_R$	470 to 68000 $\mu\text{F}$	47 to 1500 $\mu\text{F}$
Tolerance on $C_R$	$\pm 20\%$	
Rated voltage range, $U_R$ ; note 1	10 to 100 V	200 to 450 V
Category temperature range	- 40 to + 85 °C	
Endurance test at 85 °C	5000 hours (450 V: 2000 hours)	
Useful life at 85 °C	12000 hours (450 V: 5000 hours)	
Useful life at 40 °C and $1.4 \times I_R$ applied	210000 hours (450 V: 90000 hours)	
Shelf life at 0 V, 85 °C	500 hours	
Based on sectional specification	IEC 60384-4/EN130300	
Climatic category IEC 60068	40/085/56	

**Note**

1. A 420 V range is available on request.

**SELECTION CHART FOR  $C_R$ ,  $U_R$  AND RELEVANT NOMINAL CASE SIZES FOR 056 SERIES ( $\varnothing D \times L$  in mm)**

$C_R$ ( $\mu\text{F}$ )	$U_R$ (V)						
	10	16	25	40	50	63	100
470	-	-	-	-	-	-	22 × 25
680	-	-	-	-	-	-	22 × 30
1000	-	-	-	-	-	22 × 25	25 × 30
	-	-	-	-	-	-	22 × 40
1500	-	-	-	-	22 × 25	22 × 30	30 × 30
	-	-	-	-	-	-	25 × 40
2200	-	-	-	22 × 25	22 × 30	25 × 30	30 × 40
	-	-	-	-	-	22 × 40	25 × 50
3300	-	-	22 × 25	22 × 30	25 × 30	30 × 30	35 × 40
	-	-	-	-	22 × 40	25 × 40	30 × 50

\* Pb containing terminations are not RoHS compliant, exemptions may apply

**SELECTION CHART FOR  $C_R$ ,  $U_R$  AND RELEVANT NOMINAL CASE SIZES FOR 056 SERIES** ( $\varnothing D \times L$  in mm)

$C_R$ ( $\mu F$ )	$U_R$ (V)						
	10	16	25	40	50	63	100
4700	–	22 × 25	22 × 30	25 × 30	30 × 30	30 × 40	35 × 50
	–	–	–	22 × 40	25 × 40	25 × 50	–
6800	22 × 25	22 × 30	25 × 30	30 × 30	30 × 40	35 × 40	–
	–	–	22 × 40	25 × 40	25 × 50	30 × 50	–
10000	22 × 30	25 × 30	30 × 30	30 × 40	35 × 40	35 × 50	–
	–	22 × 40	25 × 40	25 × 50	30 × 50	–	–
15000	25 × 30	30 × 30	30 × 40	35 × 40	35 × 50	–	–
	22 × 40	25 × 40	25 × 50	30 × 50	–	–	–
22000	30 × 30	30 × 40	35 × 40	35 × 50	–	–	–
	25 × 40	25 × 50	30 × 50	–	–	–	–
33000	30 × 40	35 × 40	35 × 50	–	–	–	–
	25 × 50	30 × 50	–	–	–	–	–
47000	35 × 40	35 × 50	–	–	–	–	–
	30 × 50	–	–	–	–	–	–
68000	35 × 50	–	–	–	–	–	–

**SELECTION CHART FOR  $C_R$ ,  $U_R$  AND RELEVANT NOMINAL CASE SIZES FOR 057 SERIES** ( $\varnothing D \times L$  in mm)

$C_R$ ( $\mu F$ )	$U_R$ (V)				
	200	250	385	400	450
47	–	–	22 × 25	22 × 25	22 × 30
68	–	–	22 × 30	22 × 30	22 × 30
100	–	22 × 25	25 × 30	25 × 30	30 × 30
	–	–	22 × 40	22 × 35	25 × 35
	–	–	22 × 35	–	–
150	22 × 25	22 × 30	30 × 30	30 × 30	25 × 50
	–	–	25 × 40	25 × 50 <sup>(1)</sup>	30 × 35
	–	–	–	25 × 40	–
220	22 × 30	25 × 30	30 × 45	30 × 35	35 × 40
	–	22 × 40	30 × 40	25 × 50	30 × 45
	–	–	30 × 35	–	–
	–	–	25 × 50	–	–
330	25 × 30	30 × 30	35 × 35	35 × 40	35 × 50
	22 × 40	25 × 40	30 × 45	30 × 50	35 × 45
470	30 × 30	30 × 40	35 × 50	35 × 50	–
	25 × 40	25 × 50	35 × 45	–	–
680	30 × 40	35 × 40	–	–	–
	25 × 50	30 × 50	–	–	–
1000	35 × 40	35 × 50	–	–	–
	30 × 50	–	–	–	–
1500	35 × 50	–	–	–	–

**Notes**

- Ripple current optimized types.

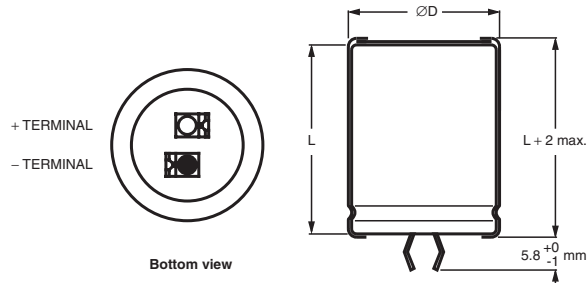
**DIMENSIONS** in millimeters **AND AVAILABLE FORMS**
**TWO TERMINALS SNAP-IN**

The minus terminal can be marked with a black dot or with an imprinted '-' sign.

Fig.2 Two terminal snap-in.

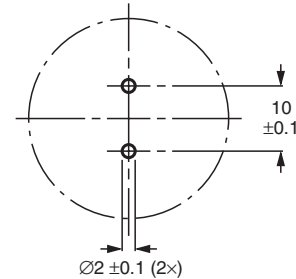
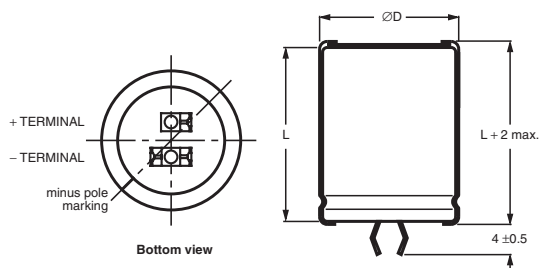
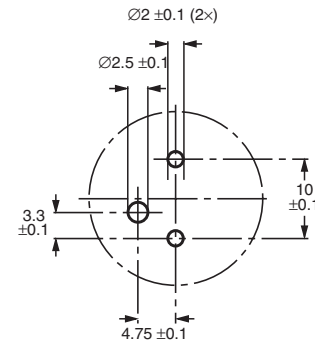

Fig.3 Mounting hole diagram.

**THREE TERMINAL SNAP-IN**

The negative terminal has **TWO** pins which are **BOTH** electrically connected.

Fig.4 Three terminal snap-in.



The 10 mm spacing of the 2 pin snap-in is used as the base layout and a third hole is added.

The third hole is closer to the negative primary hole so that polarization is always maintained, together with added mechanical stability.

Fig.5 Mounting hole diagram.

Table 1

<b>DIMENSIONS</b> in millimeters, <b>MASS AND PACKAGING QUANTITIES</b>					
<b>NOMINAL CASE SIZE</b> ØD × L	ØD <sub>max</sub>	L <sub>max</sub>	<b>MASS</b> (g)	<b>PACKAGING QUANTITIES</b> (units per box)	<b>CARDBOARD BOX DIMENSIONS</b> L x W x H (mm)
22 × 25	23	27	≈12	100	260 × 250 × 39
22 × 30	23	32	≈16	100	260 × 250 × 44
22 × 35	23	37	≈20	100	260 × 250 × 49
22 × 40	23	42	≈23	100	260 × 250 × 54
25 × 30	26	32	≈22	100	290 × 280 × 44
25 × 35	26	37	≈24	100	290 × 280 × 49
25 × 40	26	42	≈27	100	290 × 280 × 54
25 × 50	26	52	≈38	100	290 × 280 × 64
30 × 30	31	32	≈30	100	340 × 330 × 44
30 × 35	31	37	≈35	100	340 × 330 × 49
30 × 40	31	42	≈40	100	340 × 330 × 54
30 × 45	31	47	≈45	100	340 × 330 × 59
30 × 50	31	52	≈50	100	340 × 330 × 64
35 × 35	36	37	≈48	50	390 × 198 × 49
35 × 40	36	42	≈55	50	390 × 198 × 54
35 × 45	36	47	≈63	50	390 × 198 × 59
35 × 50	36	52	≈72	50	390 × 198 × 64

ELECTRICAL DATA	
SYMBOL	DESCRIPTION
$C_R$	rated capacitance at 100 Hz
$I_R$	rated RMS ripple current at 100 Hz or $\geq 10$ kHz and 85 °C
$I_{L1}$	max. leakage current after 1 minute at $U_R$
$I_{L5}$	max. leakage current after 5 minutes at $U_R$
ESR	max. equivalent series resistance at 100 Hz
Z	max. impedance at 10 kHz

**Note**

1. Unless otherwise specified, all electrical values in Tables 2 and apply at  $T_{amb} = 20$  °C,  $P = 86$  to 106 kPa,  $RH = 45$  to 75 %.

**ORDERING EXAMPLE\***

Electrolytic capacitor 056 series

10000 $\mu$ F/25 V;  $\pm 20$  %Nominal case size:  $\varnothing 25 \times 40$ mm

2-terminal snap-in:

Catalog number: 2222 056 46103.

3-terminal snap-in:

Catalog number: 2222 056 26103.

\*Note: To ensure delivery of lead (Pb)-free parts during the transition period, please contact your Vishay sales agent.

Table 2

ELECTRICAL DATA AND ORDERING INFORMATION FOR 056 SERIES										
$U_R$ (V)	CR 100 Hz (MF)	NOMINAL CASE SIZE $\varnothing D \times L$ (mm)	$I_R$ 100 Hz 85 °C (A)	$I_R$ $\geq 10$ kHz 85 °C (A)	$I_{L1}$ 1 min (mA)	$I_{L5}$ 5 min (mA)	ESR 100 Hz (m $\Omega$ )	Z 10 kHz (m $\Omega$ )	CATALOG NUMBER 2222 056 .....	
									2-TERM.	3-TERM.
10	6800	22 $\times$ 25	2.04	2.40	412	140	76	62	54682	74682
	10000	22 $\times$ 30	2.56	3.02	608	205	56	45	54103	74103
	15000	25 $\times$ 30	3.12	3.68	904	304	44	39	54153	74153
	15000	22 $\times$ 40	3.39	4.00	904	304	41	34	44153	24153
	22000	30 $\times$ 30	3.47	4.09	1324	444	44	37	54223	74223
	22000	25 $\times$ 40	4.12	4.86	1324	444	34	28	44223	24223
	33000	30 $\times$ 40	4.58	5.40	1984	664	32	28	54333	74333
	33000	25 $\times$ 50	4.70	5.55	1984	664	30	27	44333	24333
	47000	35 $\times$ 40	5.10	6.02	2824	944	31	26	54473	74473
	47000	30 $\times$ 50	5.39	6.36	2824	944	28	24	44473	24473
68000	35 $\times$ 50	5.88	6.94	4084	1364	28	23	54683	74683	
16	4700	22 $\times$ 25	2.01	2.37	455	154	79	62	55472	75472
	6800	22 $\times$ 30	2.54	3.00	657	222	57	45	55682	75682
	10000	25 $\times$ 30	3.02	3.56	964	324	47	39	55103	75103
	10000	22 $\times$ 40	3.28	3.87	964	324	44	34	45103	25103
	15000	30 $\times$ 30	3.36	3.96	1444	484	47	37	55153	75153
	15000	25 $\times$ 40	4.00	4.72	1444	484	34	28	45153	25153
	22000	30 $\times$ 40	4.51	5.32	2116	708	33	28	55223	75223
	22000	25 $\times$ 50	3.97	4.68	2116	708	42	41	45223	25223
	33000	35 $\times$ 40	5.02	5.92	3172	1060	32	28	55333	75333
	33000	30 $\times$ 50	4.75	5.61	3172	1060	36	34	45333	25333
47000	35 $\times$ 50	5.34	6.30	4516	1508	34	32	55473	75473	
25	3300	22 $\times$ 25	1.88	2.22	499	169	89	61	56332	76332
	4700	22 $\times$ 30	2.37	2.80	709	239	65	45	56472	76472
	6800	25 $\times$ 30	2.81	3.32	1024	344	54	41	56682	76682
	6800	22 $\times$ 40	3.16	3.73	1024	344	47	38	46682	26682
	10000	30 $\times$ 30	3.25	3.84	1504	504	50	38	56103	76103
	10000	25 $\times$ 40	3.73	4.40	1504	504	39	30	46103	26103
	15000	30 $\times$ 40	4.73	5.58	2254	754	30	28	56153	76153
	15000	25 $\times$ 50	3.92	4.63	2254	754	43	39	46153	26153
	22000	35 $\times$ 40	4.48	5.29	3304	1104	40	28	56223	76223
	22000	30 $\times$ 50	4.96	5.85	3304	1104	36	23	46223	26223
	33000	35 $\times$ 50	4.98	5.88	4954	1654	39	33	56333	76333



Aluminum Capacitors  
Power Standard Miniature Snap-in

<b>ELECTRICAL DATA AND ORDERING INFORMATION FOR 056 SERIES</b>										
U <sub>R</sub> (V)	CR 100 Hz (MF)	NOMINAL CASE SIZE ∅D × L (mm)	I <sub>R</sub> 100 Hz 85 °C (A)	I <sub>R</sub> ≥ 10 kHz 85 °C (A)	I <sub>L1</sub> 1 min (MA)	I <sub>L5</sub> 5 min (MA)	ESR 100 Hz (mΩ)	Z 10 kHz (mΩ)	CATALOG NUMBER 2222 056 .....	
									2-TERM.	3-TERM.
40	2200	22 × 25	1.85	2.26	532	180	92	61	57222	77222
	3300	22 × 30	2.09	2.55	796	260	67	45	57332	77332
	4700	25 × 30	2.28	2.78	1132	380	82	70	57472	77472
	4700	22 × 40	3.10	3.78	1132	380	49	38	47472	27472
	6800	30 × 30	3.16	3.85	1636	548	53	38	57682	77682
	6800	25 × 40	3.06	3.73	1636	548	58	50	47682	27682
	10000	30 × 40	4.20	5.12	2404	804	38	28	57103	77103
	10000	25 × 50	3.88	4.73	2404	804	44	39	47103	27103
	15000	35 × 40	4.05	4.94	3604	1204	49	41	57153	77153
	15000	30 × 50	4.45	5.43	3604	1204	41	34	47153	27153
	22000	35 × 50	4.86	5.93	5284	1764	40	33	57223	77223
50	1500	22 × 25	1.36	1.66	454	154	170	130	51152	71152
	2200	22 × 30	1.75	2.14	664	224	120	91	51222	71222
	3300	25 × 30	2.17	2.65	994	334	90	72	51332	71332
	3300	22 × 40	2.42	2.95	994	334	80	63	41332	21332
	4700	30 × 30	2.65	3.23	1414	474	75	63	51472	71472
	4700	25 × 40	2.89	3.53	1414	474	65	52	41472	21472
	6800	30 × 40	3.56	4.34	2044	684	53	45	51682	71682
	6800	25 × 50	3.75	4.58	2044	684	50	43	41682	21682
	10000	35 × 40	4.05	4.94	3004	1004	49	42	51103	71103
	10000	30 × 50	4.50	5.49	3004	1004	40	35	41103	21103
	15000	35 × 50	4.98	6.08	4504	1504	39	33	51153	71153
63	1000	22 × 25	1.46	1.78	382	130	148	104	58102	78102
	1500	22 × 30	1.87	2.28	571	193	105	72	58152	78152
	2200	25 × 30	2.32	2.83	836	281	79	59	58222	78222
	2200	22 × 40	2.54	3.10	836	281	73	53	48222	28222
	3300	30 × 30	2.87	3.50	1251	420	64	50	58332	78332
	3300	25 × 40	3.14	3.83	1251	420	55	44	48332	28332
	4700	30 × 40	3.67	4.48	1780	596	50	38	58472	78472
	4700	25 × 50	3.71	4.53	1780	596	48	38	48472	28472
	6800	35 × 40	4.33	5.28	2574	861	43	38	58682	78682
	6800	30 × 50	4.75	5.80	2574	861	42	37	48682	28682
	10000	35 × 50	5.26	6.42	3784	1264	35	30	58103	78103
100	470	22 × 25	0.77	0.94	286	98	535	470	59471	79471
	680	22 × 30	0.99	1.21	412	160	375	328	59681	79681
	1000	25 × 30	1.27	1.55	604	204	265	235	59102	79102
	1000	22 × 40	1.35	1.65	604	204	260	225	49102	29102
	1500	30 × 30	1.67	2.04	904	304	190	170	59152	79152
	1500	25 × 40	1.75	2.14	904	304	180	160	49152	29152
	2200	30 × 40	2.27	2.77	1324	444	130	120	59222	79222
	2200	25 × 50	2.30	2.80	1324	444	125	110	49222	29222
	3300	35 × 40	2.84	3.46	1984	664	100	95	59332	79332
	3300	30 × 50	2.97	3.62	1984	664	92	85	49332	29332
	4700	35 × 50	3.59	4.38	2824	677	75	70	59472	79472

Table 3

ELECTRICAL DATA AND ORDERING INFORMATION FOR 057 SERIES									
U <sub>R</sub> (V)	C <sub>R</sub> 100 Hz (MF)	NOMINAL CASE SIZE ∅D × L (mm)	I <sub>R</sub> 100 Hz 85 °C (A)	I <sub>L1</sub> 1 min (MA)	I <sub>L5</sub> 5 min (MA)	ESR 100 Hz (mΩ)	Z 10 kHz (mΩ)	CATALOG NUMBER 2222 057 .....	
								2-TERM.	3-TERM.
200	150	22 × 25	0.77	184	64	950	620	52151	72151
	220	22 × 30	1.00	268	92	650	435	52221	72221
	330	25 × 30	1.36	400	136	430	310	52331	72331
	330	22 × 40	1.36	400	136	430	310	42331	22331
	470	30 × 30	1.80	568	192	310	230	52471	72471
	470	25 × 40	1.80	568	192	310	230	42471	22471
	680	30 × 40	2.39	820	276	210	180	52681	72681
	680	25 × 50	2.39	820	276	210	180	42681	22681
	1000	35 × 40	2.85	1204	404	160	135	52102	72102
	1000	30 × 50	2.85	1204	404	160	135	42102	22102
1500	35 × 50	3.66	1804	604	120	105	52152	72152	
250	100	22 × 25	0.63	154	54	1440	770	53101	73101
	150	22 × 30	0.83	229	79	960	520	53151	73151
	220	25 × 30	1.10	334	114	660	365	53221	73221
	220	22 × 40	1.10	334	114	660	365	43221	23221
	330	30 × 30	1.49	499	169	440	265	53331	73331
	330	25 × 40	1.49	499	169	440	265	43331	23331
	470	30 × 40	1.98	709	239	310	185	53471	73471
	470	25 × 50	1.98	709	239	310	185	43471	23471
	680	35 × 40	2.60	1024	344	240	145	53681	73681
	680	30 × 50	2.60	1024	344	240	145	43681	23681
1000	35 × 50	3.12	1504	504	160	105	53102	73102	
385	47	22 × 25	0.50	112	40	3000	1400	58479	78479
	68	22 × 30	0.63	161	56	2100	1000	58689	68689
	100	25 × 30	0.86	235	81	1400	780	58101	78101
	100	22 × 40	0.86	235	81	1400	780	48101	68101
	100	22 × 35	0.84	235	81	1400	780	38101	88101
	150	30 × 30	1.16	350	119	950	520	58151	78151
	150	25 × 40	1.16	350	119	950	520	48151	68151
	220	30 × 45	1.63	512	173	700	460	18221	88221
	220	30 × 40	1.57	512	173	650	400	58221	78221
	220	30 × 35	1.50	512	173	650	400	38221	90051
	220	25 × 50	1.57	512	173	650	400	48221	68221
	330	35 × 35	1.73	766	258	480	280	68331	88331
	330	30 × 45	1.75	766	258	480	280	38331	78331
	470	35 × 50	2.40	1089	366	340	220	58471	78471
470	35 × 45	2.29	1089	366	340	220	48471	28471	
400	47	22 × 25	0.50	117	42	3000	1400	56479	76479
	68	22 × 30	0.63	167	58	2100	1000	56689	76689
	100	25 × 30	0.86	244	84	1400	780	56101	76101
	100	22 × 35	0.84	240	84	1400	780	36101	66101
	150	30 × 30	1.16	364	124	950	520	56151	90054
	150	25 × 50	1.50	364	124	1000	520	16151	36151
	150	25 × 40	1.16	364	124	950	520	46151	86151
	220	30 × 35	1.50	532	180	650	400	36221	90055
	220	25 × 50	1.57	532	180	650	400	46221	86221
	330	35 × 40	1.85	796	268	480	280	56331	76331
330	30 × 50	1.85	796	268	480	280	46331	26331	
470	35 × 50	2.40	1132	380	340	220	56471	76471	
450	47	22 × 30	0.26	131	45	5600	4400	67479	87479
	68	22 × 30	0.33	188	65	3900	3100	57689	77689
	100	30 × 30	0.48	274	94	2600	2100	57101	77101
	100	25 × 35	0.46	274	94	2600	2100	37101	17101
	150	30 × 35	0.66	409	140	1600	1300	37151	17151
	150	25 × 50	0.70	409	140	1600	1300	47151	27151
	220	35 × 40	0.92	598	202	1100	900	57221	77221
	220	30 × 45	0.73	598	202	1100	900	37221	17221
	330	35 × 50	1.26	895	301	700	600	57331	77331
	330	35 × 45	1.20	895	301	700	600	47331	27331



ADDITIONAL ELECTRICAL DATA		
PARAMETER	CONDITIONS	VALUE
<b>Voltage</b>		
Surge voltage	≤ 250 V versions	$U_s = 1.15 \times U_R$
	≥ 385 V versions	$U_s = 1.1 \times U_R$
Reverse voltage		$U_{rev} \leq 1 \text{ V}$
<b>Current</b>		
Leakage current	after 1 minute at $U_R$	$I_{L1} \leq 0.006 C_R \times U_R + 4 \mu\text{A}$
	after 5 minutes at $U_R$	$I_{L5} \leq 0.002 C_R \times U_R + 4 \mu\text{A}$
<b>Inductance</b>		
Equivalent series inductance (ESL)	all case sizes	typ. 19nH
		max. 25nH

**CAPACITANCE (C)**

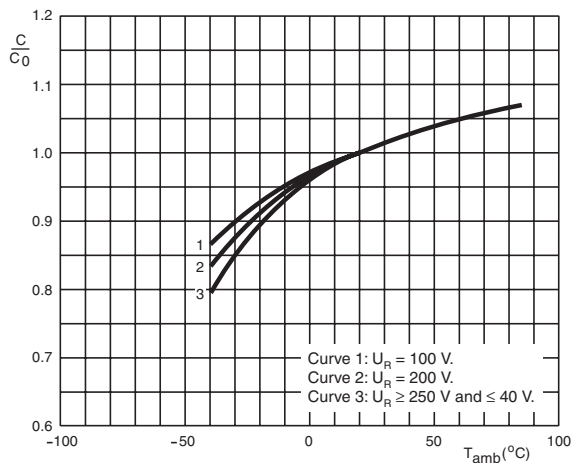

$C_0$  = capacitance at 20 °C and 100 Hz

Fig.6 Typical multiplier of capacitance as a function of ambient temperature.

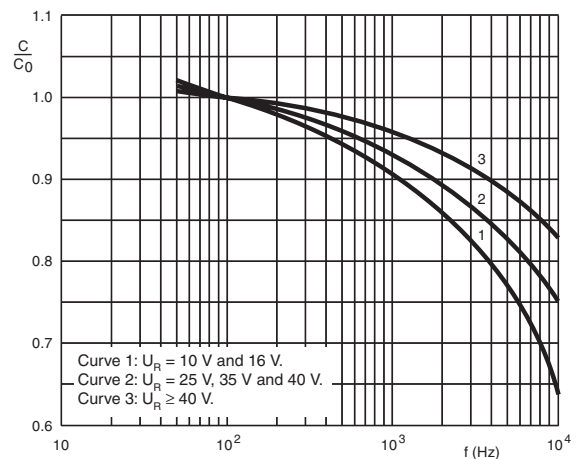

$C_0$  = capacitance at 20 °C and 100 Hz

Fig.7 Typical multiplier of capacitance as a function of frequency.

**EQUIVALENT SERIES RESISTANCE (ESR)**

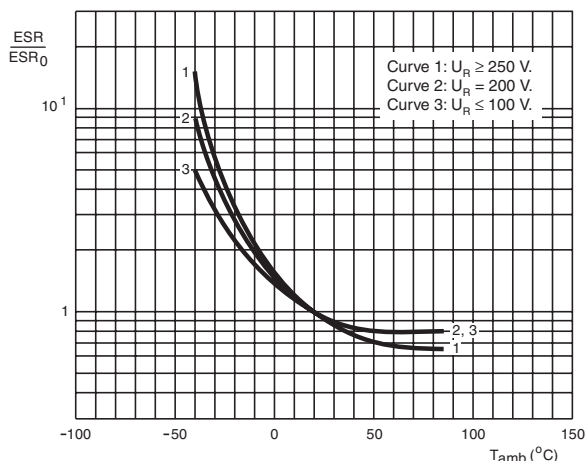

$ESR_0$  = typical at 20 °C and 100 Hz

Fig.8 Typical multiplier of ESR as a function of ambient temperature.

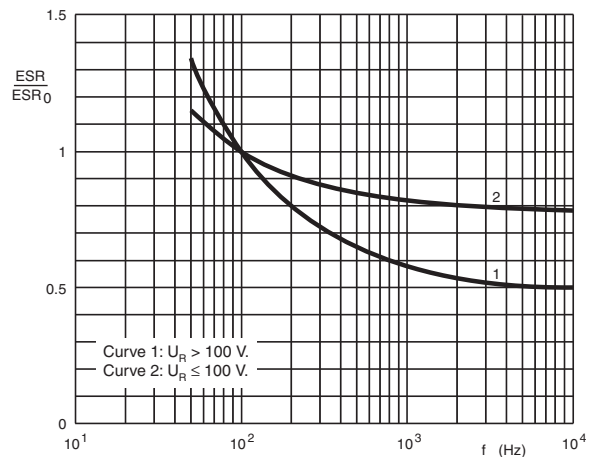

$ESR_0$  = typical at 20 °C and 100 Hz

Fig.9 Typical multiplier of ESR as a function of frequency.



**IMPEDANCE (Z)**

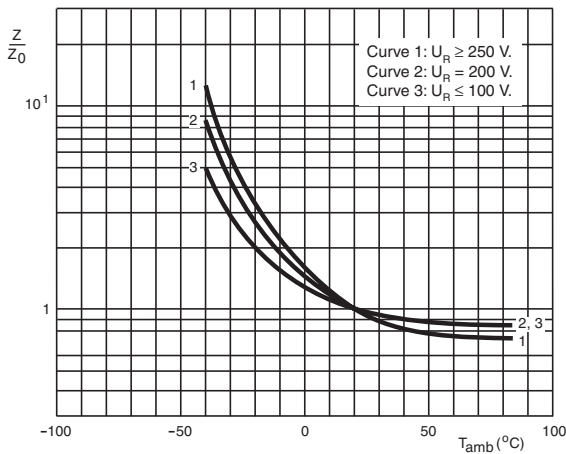

$Z_0$  = typical impedance at 20 °C and 10 kHz

Fig.10 Typical multiplier of impedance as a function of ambient temperature.

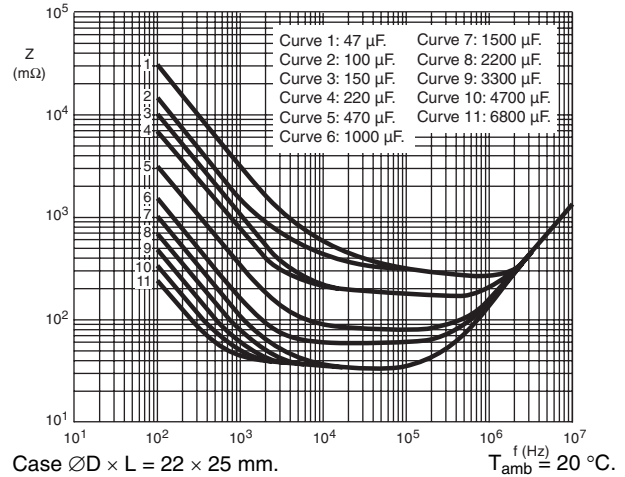
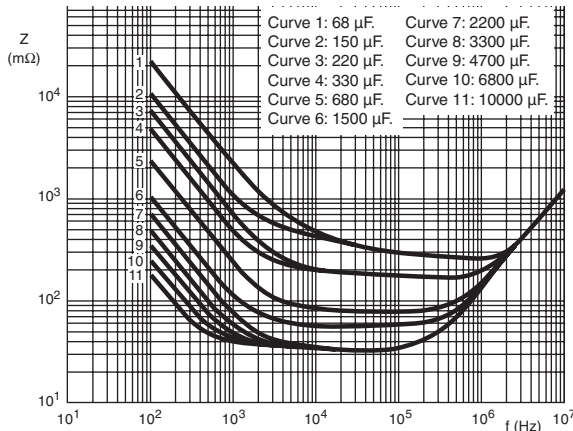
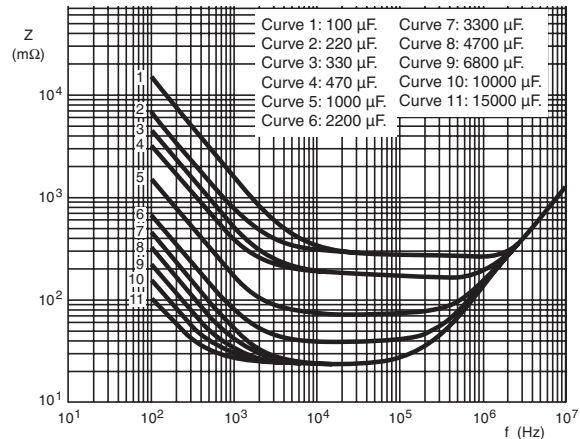

Fig.11 Typical impedance as a function of frequency.



Case  $\varnothing D \times L = 22 \times 30$  mm.  $T_{amb} = 20$  °C.

Fig.12 Typical impedance as a function of frequency.



Case  $\varnothing D \times L = 25 \times 30$  and  $22 \times 40$  mm.  $T_{amb} = 20$  °C.

Fig.13 Typical impedance as a function of frequency.

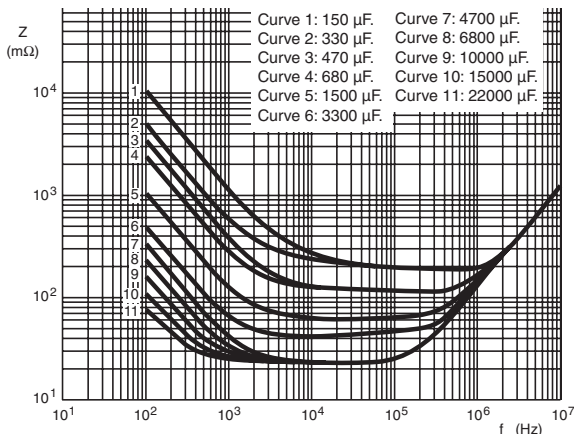

Case  $\varnothing D \times L = 30 \times 30$  and  $25 \times 40$  mm.  $T_{amb} = 20$  °C.

Fig.14 Typical impedance as a function of frequency.

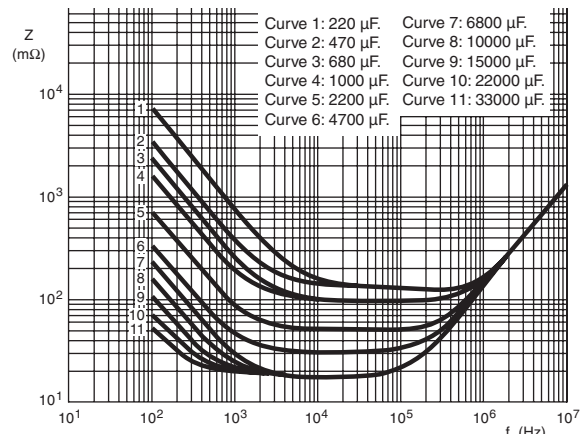

Case  $\varnothing D \times L = 30 \times 40$  and  $25 \times 50$  mm.  $T_{amb} = 20$  °C.

Fig.15 Typical impedance as a function of frequency.



**IMPEDANCE (Z)**

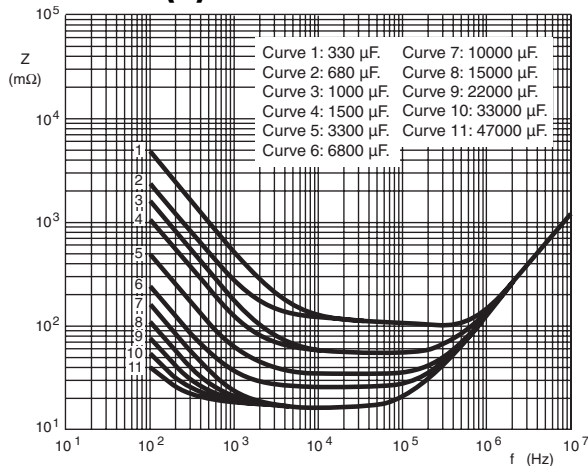

Case  $\varnothing D \times L = 35 \times 40$  and  $30 \times 50$  mm.  $T_{amb} = 20$  °C.

Fig.16 Typical impedance as a function of frequency.

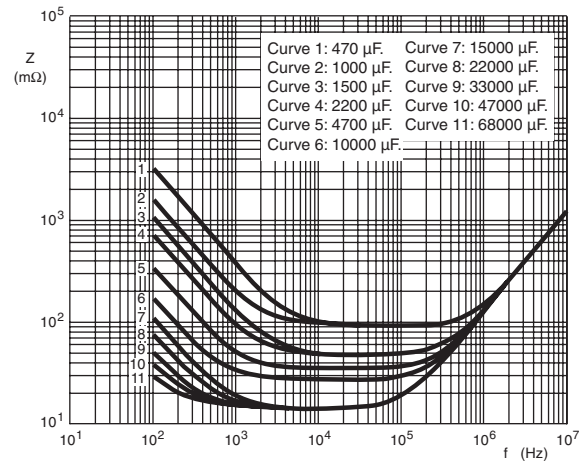

Case  $\varnothing D \times L = 35 \times 50$  mm.  $T_{amb} = 20$  °C.

Fig.17 Typical impedance as a function of frequency.

**RIPPLE CURRENT AND USEFUL LIFE**

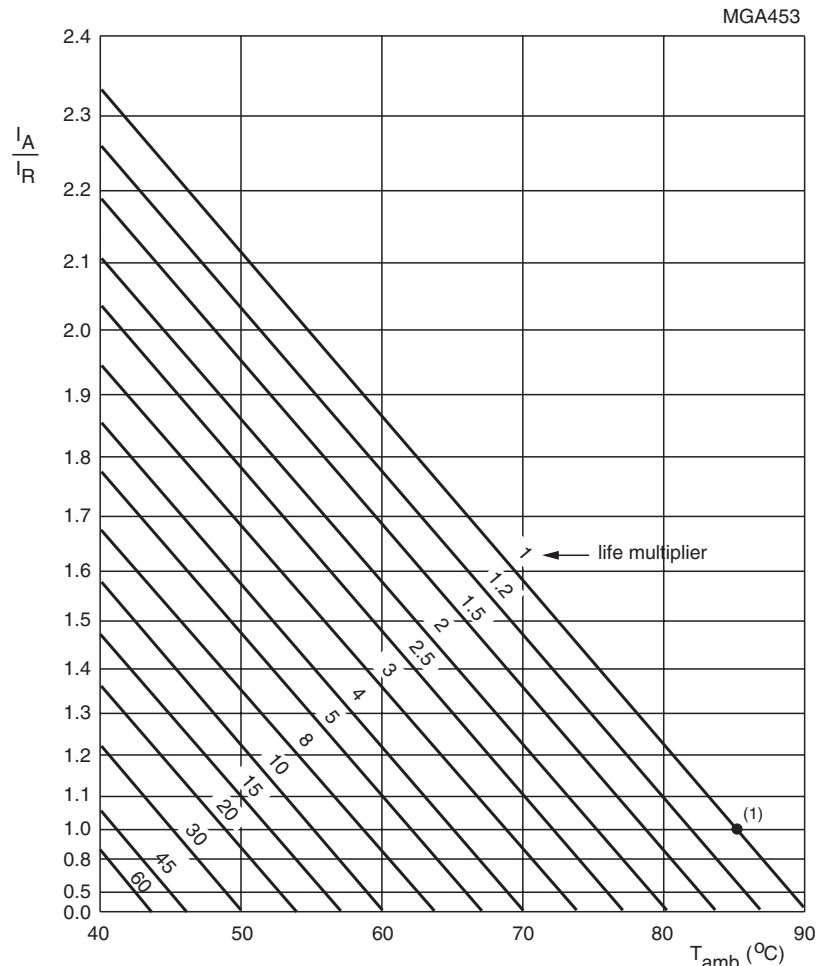

$I_A$  = actual ripple current at 100 Hz and 85 °C.  
 $I_R$  = rated ripple current at 100 Hz and 85 °C.  
 (1) Useful life at 85 °C and  $I_R$  applied:  
 12000 hours (450 V types: 5000 hours).

Fig.18 Multiplier of useful life as a function of ambient temperature and ripple current load.

Table 4

<b>MULTIPLIER OF RIPPLE CURRENT (<math>I_R</math>) AS A FUNCTION OF FREQUENCY</b>			
FREQUENCY (Hz)	$I_R$ MULTIPLIER		
	$U_R = 10$ to 25 V	$U_R = 40$ to 100 V	$U_R > 100$ V
50	0.93	0.91	0.86
100	1.00	1.00	1.00
200	1.04	1.05	1.13
400	1.07	1.09	1.21
1000	1.11	1.13	1.29
2000	1.13	1.15	1.32
4000	1.15	1.18	1.35
$\geq 10000$	1.18	1.22	1.40

Table 5

<b>TEST PROCEDURES AND REQUIREMENTS</b>			
TEST		PROCEDURE (quick reference)	REQUIREMENTS
NAME OF TEST	REFERENCE		
Endurance	IEC 60384-4/ EN130300 subclause 4.13	$T_{amb} = 85$ °C; $U_R$ applied; 5000 hours (450 V types: 2000 hours)	$U_R \leq 100$ V; $\Delta C/C$ : $\pm 15$ % $U_R > 100$ V; $\Delta C/C$ : $\pm 10$ % $ESR \leq 1.3 \times$ spec. limit $Z \leq 2 \times$ spec. limit $I_{L5} \leq$ spec. limit
Useful life	CECC 30301 subclause 1.8.1	$T_{amb} = 85$ °C; $U_R$ and $I_R$ applied; 12000 hours (450 V types: 5000 hours)	$U_R \leq 100$ V; $\Delta C/C$ : $\pm 45$ % $U_R > 100$ V; $\Delta C/C$ : $\pm 30$ % $ESR \leq 3 \times$ spec. limit $Z \leq 3 \times$ spec. limit $I_{L5} \leq$ spec. limit no short or open circuit, no visible damage total failure percentage: $U_R \leq 100$ V: $\leq 1$ %; $U_R > 100$ V: $\leq 3$ %
Shelf life (storage at high temperature)	IEC 60384-4/ EN130300 subclause 4.17	$T_{amb} = 85$ °C; no voltage applied; 500 hours after test: $U_R$ to be applied for 30 minutes, 24 to 48 hours before measurement	$\Delta C/C$ : $\pm 10$ % $ESR \leq 1.2 \times$ spec. limit $I_{L5} \leq 2 \times$ spec. limit



## Notice

Specifications of the products displayed herein are subject to change without notice. Vishay Intertechnology, Inc., or anyone on its behalf, assumes no responsibility or liability for any errors or inaccuracies.

Information contained herein is intended to provide a product description only. No license, express or implied, by estoppel or otherwise, to any intellectual property rights is granted by this document. Except as provided in Vishay's terms and conditions of sale for such products, Vishay assumes no liability whatsoever, and disclaims any express or implied warranty, relating to sale and/or use of Vishay products including liability or warranties relating to fitness for a particular purpose, merchantability, or infringement of any patent, copyright, or other intellectual property right.

The products shown herein are not designed for use in medical, life-saving, or life-sustaining applications. Customers using or selling these products for use in such applications do so at their own risk and agree to fully indemnify Vishay for any damages resulting from such improper use or sale.