

# DATA SHEET

**021 ASM**  
**Aluminum electrolytic capacitors**  
**Axial Standard Miniature**

Product specification  
Supersedes data of 12th June 2002  
File under BCcomponents, BC01

2003 Feb 25

# Aluminum electrolytic capacitors

## Axial Standard Miniature

021 ASM

### FEATURES

- Polarized aluminum electrolytic capacitors, non-solid electrolyte
- Axial leads, cylindrical aluminum case, insulated with a blue sleeve
- Mounting ring version not insulated
- Charge and discharge proof
- Taped versions up to case  $\varnothing 15 \times 30$  mm available for automatic insertion
- Miniaturized, high CV-product per unit volume.

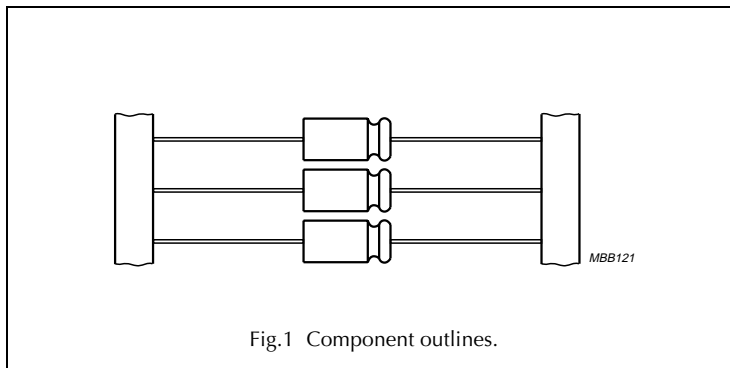
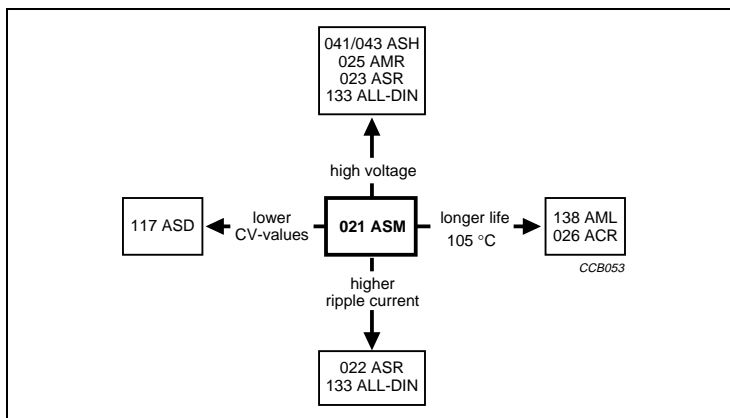

Fig.1 Component outlines.

### APPLICATIONS

- General purpose, industrial, automotive, audio-video
- Coupling, decoupling, smoothing, filtering, buffering
- Portable and mobile equipment (small size, low mass)
- Low mounting height boards, vibration and shock resistant.



### QUICK REFERENCE DATA

DESCRIPTION	VALUE	
Case sizes ( $\varnothing D_{nom} \times L_{nom}$ in mm)	4.5 × 10 to 10 × 25	10 × 30 to 21 × 38
Rated capacitance range, $C_R$	0.47 to 15 000 $\mu$ F	
Tolerance on $C_R$	±20%	
Rated voltage range, $U_R$	6.3 to 100 V	
Category temperature range	-40 to +85 °C	
Endurance test at 85 °C:		
$U_R = 6.3$ to 25 V	1 000 hours	5 000 hours
$U_R = 40$ to 100 V	2 000 hours	5 000 hours
Endurance test at 105 °C	–	1 500 hours
Useful life at 85 °C	2 500 hours	8 000 hours
Useful life at 40 °C, $1.4 \times I_R$ applied	70 000 hours	200 000 hours
Shelf life at 0 V, 85 °C	500 hours	500 hours
Based on sectional specification	IEC 60384-4/EN130300	
Climatic category IEC 60068	40/085/56	

# Aluminum electrolytic capacitors

## Axial Standard Miniature

**021 ASM**
**Selection chart for  $C_R$ ,  $U_R$  and relevant nominal case sizes ( $\varnothing D \times L$  in mm)**

 Preferred types in **bold**.

$C_R$ ( $\mu\text{F}$ )	$U_R$ (V)						
	6.3	10	16	25	40	63	100
0.47	–	–	–	–	–	4.5 × 10	–
<b>1</b>	–	–	–	–	–	<b>4.5 × 10</b>	4.5 × 10
<b>2.2</b>	–	–	–	–	–	<b>4.5 × 10</b>	4.5 × 10
3.3	–	–	–	–	–	4.5 × 10	–
<b>4.7</b>	–	–	–	–	–	<b>4.5 × 10</b>	4.5 × 10
<b>10</b>	–	–	–	–	–	<b>4.5 × 10</b>	6 × 10
15	–	–	–	–	–	4.5 × 10	8 × 11
	–	–	–	–	–	–	6.5 × 18
<b>22</b>	–	–	–	–	<b>4.5 × 10</b>	<b>6 × 10</b>	8 × 11
	–	–	–	–	–	–	6.5 × 18
33	–	–	–	–	–	6 × 10	6.5 × 18
<b>47</b>	–	–	–	<b>4.5 × 10</b>	<b>6 × 10</b>	8 × 11	8 × 18
	–	–	–	–	–	<b>6.5 × 18</b>	–
68	–	–	4.5 × 10	–	–	8 × 11	10 × 18
	–	–	–	–	–	6.5 × 18	–
<b>100</b>	–	<b>4.5 × 10</b>	–	<b>6 × 10</b>	8 × 11	<b>8 × 18</b>	10 × 25
	–	–	–	–	<b>6.5 × 18</b>	–	<b>10 × 30</b>
150	–	–	6 × 10	8 × 11	8 × 18	10 × 18	12.5 × 30
	–	–	–	6.5 × 18	–	–	–
<b>220</b>	–	<b>6 × 10</b>	8 × 11	<b>6.5 × 18</b>	<b>10 × 18</b>	10 × 25	<b>12.5 × 30</b>
	–	–	–	–	–	<b>10 × 30</b>	–
330	–	8 × 11	6.5 × 18	8 × 18	10 × 25	12.5 × 30	15 × 30
<b>470</b>	<b>8 × 11</b>	<b>6.5 × 18</b>	8 × 18	<b>10 × 18</b>	10 × 25	<b>12.5 × 30</b>	<b>18 × 30</b>
	–	–	–	–	<b>10 × 30</b>	–	–
680	–	8 × 18	10 × 18	10 × 25	12.5 × 30	15 × 30	18 × 38
	–	–	–	10 × 30	–	–	–
<b>1000</b>	8 × 18	<b>10 × 18</b>	<b>10 × 25</b>	<b>12.5 × 30</b>	<b>12.5 × 30</b>	<b>18 × 30</b>	<b>21 × 38</b>
	–	–	<b>10 × 30</b>	–	–	–	–
1500	–	10 × 25	12.5 × 30	12.5 × 30	15 × 30	18 × 38	–
	–	10 × 30	–	–	–	–	–
<b>2200</b>	10 × 25	<b>12.5 × 30</b>	<b>12.5 × 30</b>	<b>15 × 30</b>	<b>18 × 30</b>	<b>21 × 38</b>	–
3300	–	12.5 × 30	15 × 30	18 × 30	18 × 38	–	–
<b>4700</b>	–	<b>15 × 30</b>	<b>18 × 30</b>	<b>18 × 38</b>	<b>21 × 38</b>	–	–
6800	–	18 × 30	18 × 38	21 × 38	–	–	–
<b>10000</b>	–	<b>18 × 38</b>	<b>21 × 38</b>	–	–	–	–
15000	–	21 × 38	–	–	–	–	–

# Aluminum electrolytic capacitors

## Axial Standard Miniature

021 ASM

### MECHANICAL DATA, AVAILABLE FORMS AND PACKAGING QUANTITIES

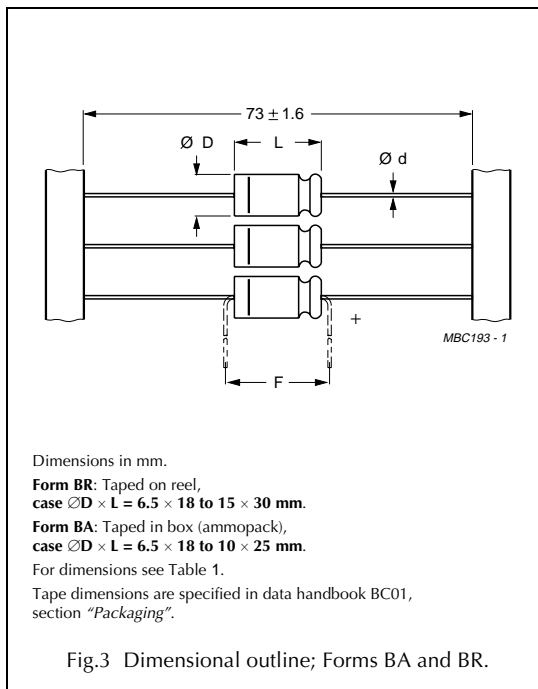
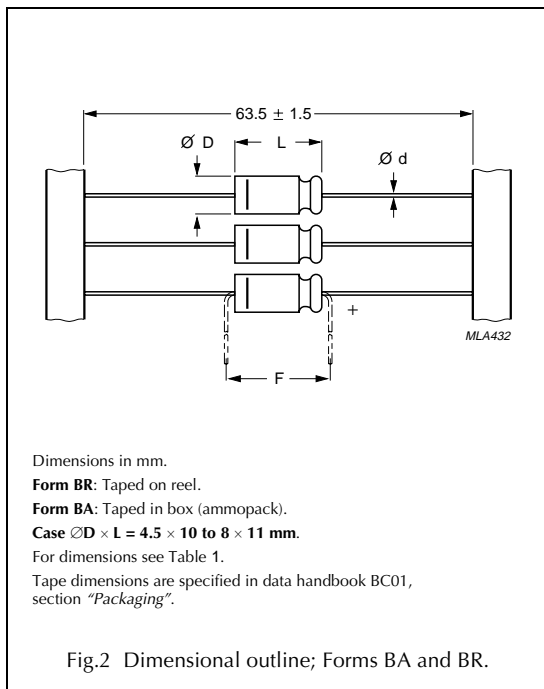

**Table 1 Axial;** physical dimensions, mass and packaging quantities; see Figs 2, 3 and 4

NOMINAL CASE SIZE $\varnothing D \times L$ (mm)	CASE CODE	AXIAL: FORM AA, BA, and BR					MASS (g)	PACKAGING QUANTITIES		
		$\varnothing d$	l	$\varnothing D_{max}$ (mm)	$L_{max}$ (mm)	$F_{min}$ (mm)		FORM AA	FORM BA	FORM BR
4.5 × 10	2	0.6	–	5.0	10.5	15	≈0.50	–	1000	3000
6 × 10	3	0.6	–	6.3	10.5	15	≈0.70	–	1000	1000
8 × 11	5a	0.6	–	8.5	11.5	15	≈1.1	–	500	500
6.5 × 18	4	0.8	–	6.9	18.5	25	≈1.3	–	1000	1000
8 × 18	5	0.8	–	8.5	18.5	25	≈1.7	–	500	500
10 × 18	6	0.8	–	10.5	18.5	25	≈2.5	–	500	500
10 × 25	7	0.8	–	10.5	25.0	30	≈3.3	–	500	500
10 × 30	00	0.8	55 ±1	10.5	30.5	35	≈4.8	340	–	500
12.5 × 30	01	0.8	55 ±1	13.0	30.5	35	≈7.4	260	–	400
15 × 30	02	0.8	55 ±1	15.5	30.5	35	≈11.7	300	–	250
18 × 30	03	0.8	55 ±1	18.5	30.5	35	≈12.9	200	–	–
18 × 38	04	0.8	34 ±1	18.5	39.0	44	≈19.0	125	–	–
21 × 38	05	0.8	34 ±1	21.5	39.0	44	≈24.0	100	–	–

# Aluminum electrolytic capacitors

## Axial Standard Miniature

021 ASM

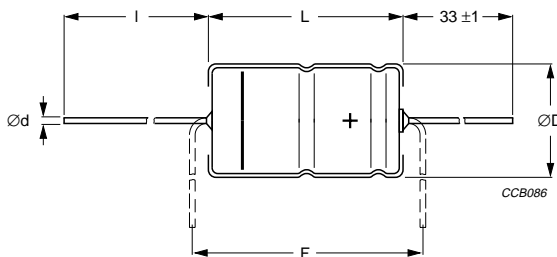

Dimensions in mm.

**Form AA:** Axial in box.

**Case**  $\varnothing D \times L = 10 \times 30$  to  $21 \times 38$  mm.

For dimensions see Table 1.

Fig.4 Dimensional outline; Form AA.

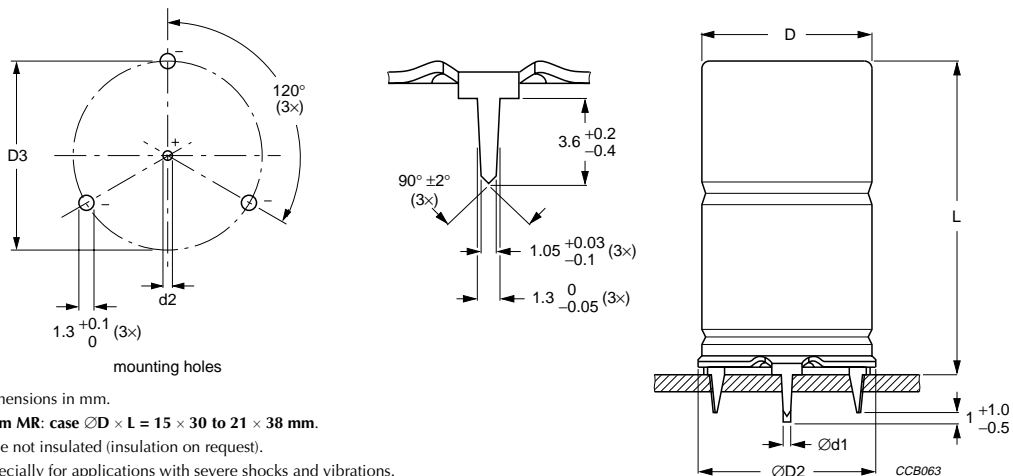

Dimensions in mm.

**Form MR:** case  $\varnothing D \times L = 15 \times 30$  to  $21 \times 38$  mm.

Case not insulated (insulation on request).

Especially for applications with severe shocks and vibrations.

For dimensions see Table 2.

Fig.5 Mounting hole diagram and outline; Form MR; with mounting ring and pins.

**Table 2 Mounting ring;** mass and packaging quantities; see Fig.5

NOMINAL CASE SIZE $\varnothing D \times L$ (mm)	CASE CODE	MOUNTING RING: FORM MR					MASS (g)	PACKAGING QUANTITIES
		$\varnothing d1$ (mm)	$\varnothing d2$ (mm)	$\varnothing D2_{max}$ (mm)	D3 (mm)	$L_{max}$ (mm)		
15 × 30	02	0.8	1.0 +0.4	17.5	16.5 ±0.2	33	≈11.7	200
18 × 30	03	0.8	1.0 +0.4	19.5	18.5 ±0.2	33	≈12.9	240
18 × 38	04	0.8	1.0 +0.4	19.5	18.5 ±0.2	42	≈19.0	100
21 × 38	05	0.8	1.0 +0.4	22.5	21.5 ±0.2	42	≈24.0	100

# Aluminum electrolytic capacitors

## Axial Standard Miniature

### 021 ASM

#### ELECTRICAL DATA AND ORDERING INFORMATION

Unless otherwise specified, all electrical values in Table 3 apply at  $T_{amb} = 20\text{ °C}$ ,  
 $P = 86$  to  $106\text{ kPa}$ ,  $RH = 45$  to  $75\%$ .

SYMBOL	DESCRIPTION
$C_R$	rated capacitance at 100 Hz, tolerance $\pm 20\%$
$I_R$	rated RMS ripple current at 100 Hz, $85\text{ °C}$
$I_{L5}$	max. leakage current after 5 minutes at $U_R$
$\tan \delta$	max. dissipation factor at 100 Hz
ESR	equivalent series resistance at 100 Hz (calculated from $\tan \delta_{max}$ and $C_R$ )
Z	max. impedance at 10 kHz

#### Ordering example

Electrolytic capacitor 021 series

1000  $\mu\text{F}/16\text{ V}$ ;  $\pm 20\%$

Nominal case size:  $\varnothing 10 \times 25\text{ mm}$ ;  
Form BA

Catalogue number: 2222 021 90518.

**Table 3** Electrical data and ordering Information; preferred types in **bold**

$U_R$ (V)	$C_R$ 100 Hz ( $\mu\text{F}$ )	NOMINAL CASE SIZE $\varnothing D \times L$ (mm)	$I_R$ 100 Hz $85\text{ °C}$ (mA)	$I_{L5}$ 5 min ( $\mu\text{A}$ )	$\tan \delta$ 100 Hz	ESR 100 Hz ( $\Omega$ )	Z 10 kHz ( $\Omega$ )	CATALOGUE NUMBER 2222 021 .....			
								IN BOX FORM AA	TAPED ON REEL FORM BR	TAPED IN BOX FORM BA	MOUNTING RING FORM MR
6.3	<b>470</b>	<b>8 × 11</b>	260	10	0.25	0.85	0.64	–	23471	<b>33471</b>	–
	1000	8 × 18	440	17	0.25	0.4	0.5	–	23102	33102	–
	2200	10 × 25	710	32	0.29	0.21	0.16	–	90588	90589	–
10	<b>100</b>	<b>4.5 × 10</b>	100	6	0.20	3.2	2.0	–	24101	<b>34101</b>	–
	<b>220</b>	<b>6 × 10</b>	160	8.4	0.20	1.5	0.91	–	24221	<b>34221</b>	–
	330	8 × 11	230	11	0.20	1.0	0.61	–	24331	34331	–
	<b>470</b>	<b>6.5 × 18</b>	310	13	0.20	0.68	0.43	–	24471	<b>34471</b>	–
	680	8 × 18	400	18	0.20	0.47	0.29	–	24681	34681	–
	<b>1000</b>	<b>10 × 18</b>	550	24	0.20	0.32	0.20	–	24102	<b>34102</b>	–
	1500	10 × 25	690	34	0.23	0.25	0.18	–	90524	90525	–
	1500	10 × 30	740	34	0.23	0.245	0.18	14152	24152	–	–
	<b>2200</b>	<b>12.5 × 30</b>	980	48	0.25	0.177	0.095	<b>14222</b>	<b>24222</b>	–	–
	3300	12.5 × 30	1090	70	0.27	0.128	0.095	14332	24332	–	–
	<b>4700</b>	<b>15 × 30</b>	1320	98	0.29	0.100	0.07	<b>14472</b>	<b>24472</b>	–	<b>44472</b>
	6800	18 × 30	1590	140	0.34	0.079	0.065	14682	–	–	44682
<b>10000</b>	<b>18 × 38</b>	2090	204	0.40	0.064	0.04	<b>14103</b>	–	–	<b>44103</b>	
15000	21 × 38	2250	304	0.50	0.054	0.035	14153	–	–	44153	
16	68	4.5 × 10	90	6.2	0.16	3.8	2.4	–	25689	35689	–
	150	6 × 10	140	8.8	0.16	1.7	1.1	–	25151	35151	–
	220	8 × 11	210	11	0.16	1.2	0.73	–	25221	35221	–
	330	6.5 × 18	290	15	0.16	0.77	0.48	–	25331	35331	–
	470	8 × 18	380	19	0.16	0.55	0.34	–	25471	35471	–
	680	10 × 18	500	26	0.16	0.38	0.24	–	25681	35681	–
	<b>1000</b>	<b>10 × 25</b>	660	36	0.16	0.26	0.18	–	90517	<b>90518</b>	–
	<b>1000</b>	<b>10 × 30</b>	700	36	0.16	0.260	0.175	<b>15102</b>	<b>25102</b>	–	–
	1500	12.5 × 30	950	52	0.19	0.205	0.095	15152	25152	–	–

# Aluminum electrolytic capacitors

## Axial Standard Miniature

021 ASM

U <sub>R</sub> (V)	C <sub>R</sub> 100 Hz (μF)	NOMINAL CASE SIZE ØD × L (mm)	I <sub>R</sub> 100 Hz 85 °C (mA)	I <sub>L5</sub> 5 min (μA)	Tan δ 100 Hz	ESR 100 Hz (Ω)	Z 10 kHz (Ω)	CATALOGUE NUMBER 2222 021 .....			
								IN BOX FORM AA	TAPED ON REEL FORM BR	TAPED IN BOX FORM BA	MOUNTING RING FORM MR
16	<b>2200</b>	<b>12.5 × 30</b>	1040	74	0.21	0.150	0.095	<b>15222</b>	<b>25222</b>	–	–
	3300	15 × 30	1290	110	0.23	0.111	0.07	15332	25332	–	45332
	<b>4700</b>	<b>18 × 30</b>	1560	154	0.25	0.087	0.065	<b>15472</b>	–	–	<b>45472</b>
	6800	18 × 38	2040	222	0.30	0.070	0.04	15682	–	–	45682
	<b>10000</b>	<b>21 × 38</b>	2170	324	0.36	0.058	0.035	<b>15103</b>	–	–	<b>45103</b>
25	<b>47</b>	<b>4.5 × 10</b>	80	6.4	0.14	4.8	2.6	–	26479	<b>36479</b>	–
	<b>100</b>	<b>6 × 10</b>	150	9	0.14	2.3	1.2	–	26101	<b>36101</b>	–
	150	8 × 11	190	12	0.14	1.5	0.80	–	90534	90535	–
	150	6.5 × 18	210	12	0.14	1.5	0.80	–	26151	36151	–
	<b>220</b>	<b>6.5 × 18</b>	250	15	0.14	1.0	0.55	–	26221	<b>36221</b>	–
	330	8 × 18	340	21	0.14	0.68	0.36	–	26331	36331	–
	<b>470</b>	<b>10 × 18</b>	450	28	0.14	0.48	0.26	–	26471	<b>36471</b>	–
	680	10 × 25	560	38	0.14	0.33	0.18	–	90527	90528	–
	680	10 × 30	640	38	0.14	0.323	0.175	16681	26681	–	–
	<b>1000</b>	<b>12.5 × 30</b>	840	54	0.14	0.220	0.095	<b>16102</b>	<b>26102</b>	–	–
	1500	12.5 × 30	950	79	0.17	0.179	0.095	16152	26152	–	–
	<b>2200</b>	<b>15 × 30</b>	1180	114	0.19	0.132	0.07	<b>16222</b>	<b>26222</b>	–	<b>46222</b>
	3300	18 × 30	1470	169	0.21	0.099	0.065	16332	–	–	46332
	<b>4700</b>	<b>18 × 38</b>	1920	239	0.23	0.079	0.04	<b>16472</b>	–	–	<b>46472</b>
6800	21 × 38	2070	344	0.28	0.064	0.035	16682	–	–	46682	
40	<b>22</b>	<b>4.5 × 10</b>	60	5.8	0.11	8.0	3.2	–	27229	<b>37229</b>	–
	<b>47</b>	<b>6 × 10</b>	110	7.8	0.11	3.8	1.5	–	27479	<b>37479</b>	–
	100	8 × 11	170	12	0.11	1.8	0.70	–	90537	90538	–
	<b>100</b>	<b>6.5 × 18</b>	190	12	0.11	1.8	0.70	–	27101	<b>37101</b>	–
	150	8 × 18	250	16	0.11	1.1	0.47	–	27151	37151	–
	<b>220</b>	<b>10 × 18</b>	330	22	0.11	0.8	0.32	–	27221	<b>37221</b>	–
	330	10 × 25	430	30	0.11	0.53	0.21	–	27331	37331	–
	470	10 × 25	520	42	0.11	0.37	0.18	–	90514	90515	–
	<b>470</b>	<b>10 × 30</b>	590	42	0.12	0.404	0.175	<b>17471</b>	<b>27471</b>	–	–
	680	12.5 × 30	800	58	0.12	0.297	0.110	17681	27681	–	–
	<b>1000</b>	<b>12.5 × 30</b>	900	84	0.12	0.190	0.110	<b>17102</b>	<b>27102</b>	–	–
	1500	15 × 30	1120	124	0.15	0.159	0.07	17152	27152	–	47152
	<b>2200</b>	<b>18 × 30</b>	1390	180	0.17	0.118	0.065	<b>17222</b>	–	–	<b>47222</b>
	3300	18 × 38	1810	268	0.19	0.090	0.04	17332	–	–	47332
<b>4700</b>	<b>21 × 38</b>	1940	380	0.21	0.072	0.035	<b>17472</b>	–	–	<b>47472</b>	
63	0.47	4.5 × 10	8	4.1	0.09	310	120	–	28477	38477	–
	<b>1</b>	<b>4.5 × 10</b>	12	4.1	0.09	150	55	–	28108	<b>38108</b>	–
	<b>2.2</b>	<b>4.5 × 10</b>	21	4.3	0.09	65	25	–	28228	<b>38228</b>	–
	3.3	4.5 × 10	25	4.4	0.09	44	17	–	28338	38338	–
	<b>4.7</b>	<b>4.5 × 10</b>	31	4.6	0.09	31	12	–	28478	<b>38478</b>	–

# Aluminum electrolytic capacitors

## Axial Standard Miniature

021 ASM

U <sub>R</sub> (V)	C <sub>R</sub> 100 Hz (μF)	NOMINAL CASE SIZE ∅D × L (mm)	I <sub>R</sub> 100 Hz 85 °C (mA)	I <sub>L5</sub> 5 min (μA)	Tan δ 100 Hz	ESR 100 Hz (Ω)	Z 10 kHz (Ω)	CATALOGUE NUMBER 2222 021 .....			
								IN BOX FORM AA	TAPED ON REEL FORM BR	TAPED IN BOX FORM BA	MOUNTING RING FORM MR
63	<b>10</b>	<b>4.5 × 10</b>	50	5.3	0.08	13	5.5	–	28109	<b>38109</b>	–
	15	4.5 × 10	55	5.9	0.08	8.5	3.7	–	28159	38159	–
	<b>22</b>	<b>6 × 10</b>	90	6.8	0.08	5.8	2.5	–	28229	<b>38229</b>	–
	33	6 × 10	100	8.2	0.08	3.9	1.7	–	28339	38339	–
	47	8 × 11	140	10	0.08	2.7	1.2	–	90541	90542	–
	<b>47</b>	<b>6.5 × 18</b>	150	10	0.08	2.7	1.2	–	28479	<b>38479</b>	–
	68	8 × 11	160	13	0.08	1.9	0.81	–	90544	90545	–
	68	6.5 × 18	170	13	0.08	1.9	0.81	–	28689	38689	–
	<b>100</b>	<b>8 × 18</b>	250	17	0.08	1.3	0.55	–	28101	<b>38101</b>	–
	150	10 × 18	320	23	0.08	0.85	0.37	–	28151	38151	–
	220	10 × 25	430	32	0.08	0.60	0.25	–	90511	90512	–
	<b>220</b>	<b>10 × 30</b>	480	32	0.08	0.614	0.26	<b>18221</b>	<b>28221</b>	–	–
	330	12.5 × 30	610	46	0.08	0.409	0.19	18331	28331	–	–
	<b>470</b>	<b>12.5 × 30</b>	700	63	0.08	0.287	0.13	<b>18471</b>	<b>28471</b>	–	–
	680	15 × 30	890	90	0.08	0.199	0.095	18681	28681	–	48681
	<b>1000</b>	<b>18 × 30</b>	1170	130	0.08	0.135	0.075	<b>18102</b>	–	–	<b>48102</b>
	1500	18 × 38	1530	193	0.11	0.122	0.045	18152	–	–	48152
	<b>2200</b>	<b>21 × 38</b>	1780	281	0.13	0.099	0.040	<b>18222</b>	–	–	<b>48222</b>
	100	1	4.5 × 10	14	4.2	0.08	130	90	–	29108	39108
2.2		4.5 × 10	20	4.4	0.08	58	41	–	29228	39228	–
4.7		4.5 × 10	30	4.9	0.08	27	19	–	29478	39478	–
10		6 × 10	65	6	0.08	13	9	–	29109	39109	–
15		8 × 11	77	7	0.08	8.5	6	–	90547	90548	–
15		6.5 × 18	85	7	0.08	8.5	6	–	29159	39159	–
22		8 × 11	95	8.4	0.08	5.8	4.1	–	90551	90552	–
22		6.5 × 18	100	8.4	0.08	5.8	4.1	–	29229	39229	–
33		6.5 × 18	120	10.6	0.08	3.9	2.7	–	29339	39339	–
47		8 × 18	160	13.4	0.08	2.7	1.9	–	29479	39479	–
68		10 × 18	220	17.6	0.08	1.9	1.3	–	29689	39689	–
100		10 × 25	300	24	0.08	1.3	0.9	–	90531	90532	–
<b>100</b>		<b>10 × 30</b>	340	24	0.07	1.150	1.0	<b>19101</b>	<b>29101</b>	–	–
150		12.5 × 30	490	34	0.07	0.645	0.61	19151	29151	–	–
<b>220</b>		<b>12.5 × 30</b>	560	48	0.08	0.610	0.56	<b>19221</b>	<b>29221</b>	–	–
330		15 × 30	740	70	0.09	0.420	0.40	19331	29331	–	49331
<b>470</b>		<b>18 × 30</b>	980	98	0.09	0.310	0.29	<b>19471</b>	–	–	<b>49471</b>
680		18 × 38	1260	140	0.09	0.195	0.18	19681	–	–	49681
<b>1000</b>		<b>21 × 38</b>	1470	204	0.10	0.160	0.15	<b>19102</b>	–	–	<b>49102</b>



# Aluminum electrolytic capacitors

## Axial Standard Miniature

**021 ASM****Additional electrical data**

PARAMETER	CONDITIONS	VALUE	
		AXIAL	MOUNTING RING
<b>Voltage</b>			
Surge voltage		$U_s \leq 1.15 \times U_R$	
Reverse voltage		$U_{rev} \leq 1 \text{ V}$	
<b>Current</b>			
Leakage current	after 1 minute at $U_R$	$I_{L1} \leq 0.006C_R \times U_R + 4 \mu\text{A}$	
	after 5 minutes at $U_R$ :	$I_{L5} \leq 0.002C_R \times U_R + 4 \mu\text{A}$	
<b>Inductance</b>			
Equivalent series inductance (ESL)	case $\varnothing D \times L$ mm:		
	4.5 × 10	typ. 10 nH	–
	6 × 10	typ. 22 nH	–
	8 × 11	typ. 85 nH	–
	6.5 × 18	typ. 25 nH	–
	8 × 18	typ. 40 nH	–
	10 × 18	typ. 61 nH	–
	10 × 25	typ. 38 nH	–
	10 × 30	typ. 38 nH	–
	12.5 × 30	typ. 46 nH	–
	15 × 30	typ. 48 nH	typ. 39 nH
	18 × 30	typ. 50 nH	typ. 39 nH
	18 × 38	typ. 54 nH	typ. 39 nH
21 × 38	typ. 59 nH	typ. 39 nH	

# Aluminum electrolytic capacitors

## Axial Standard Miniature

021 ASM

### Capacitance (C)

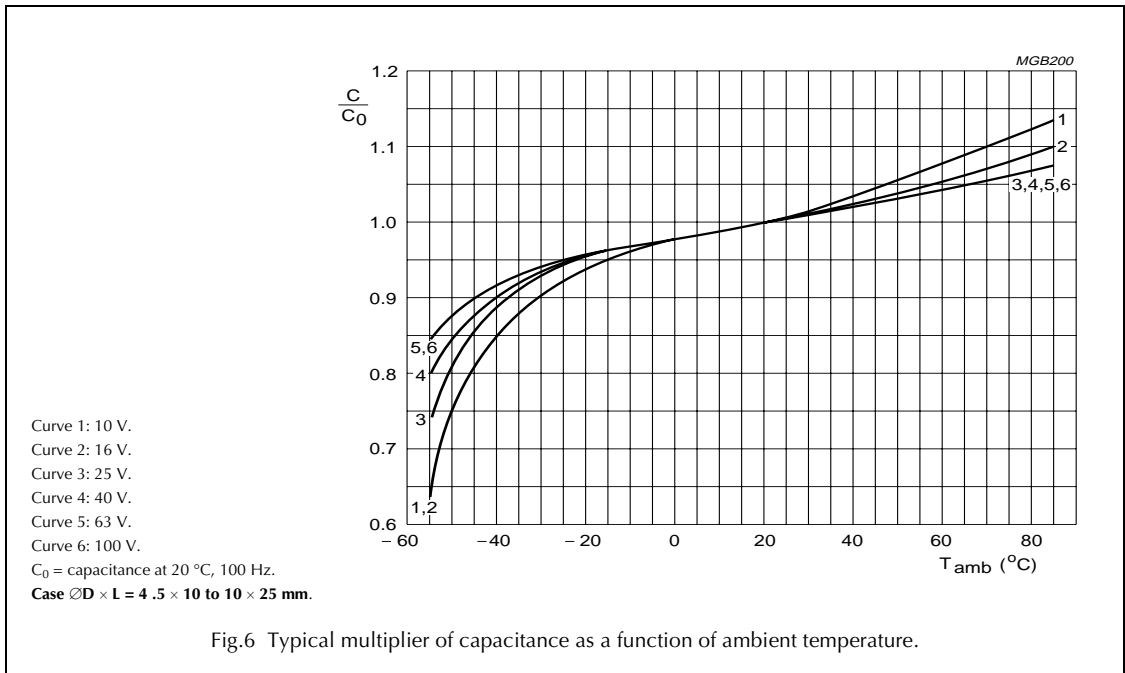

Fig.6 Typical multiplier of capacitance as a function of ambient temperature.

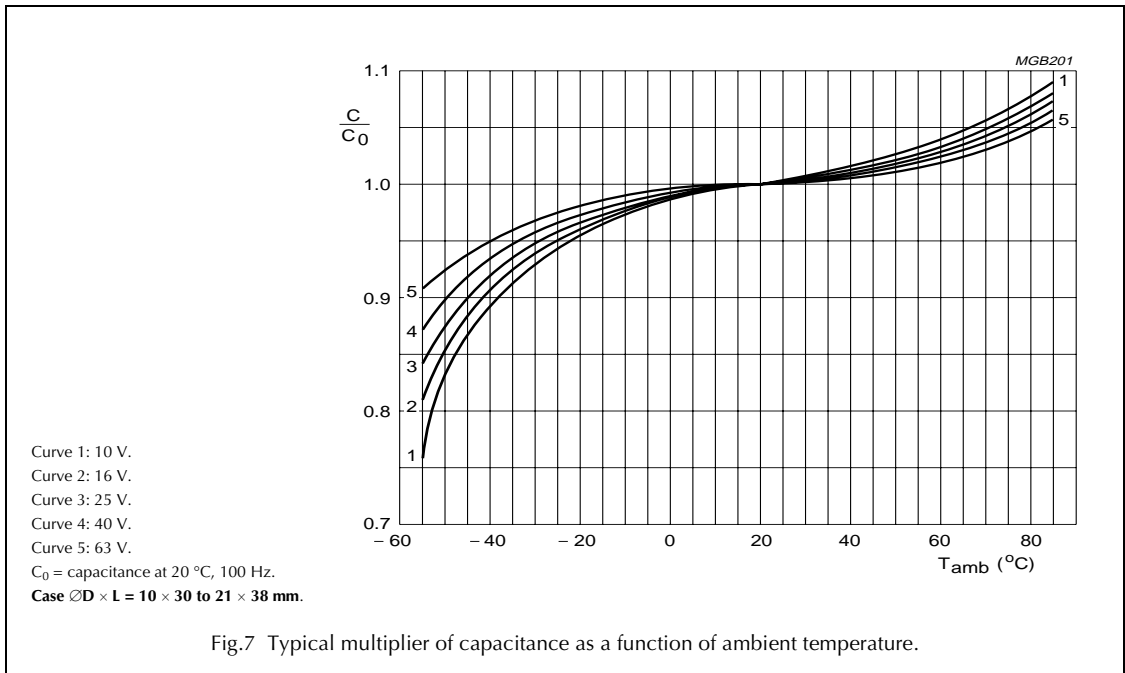
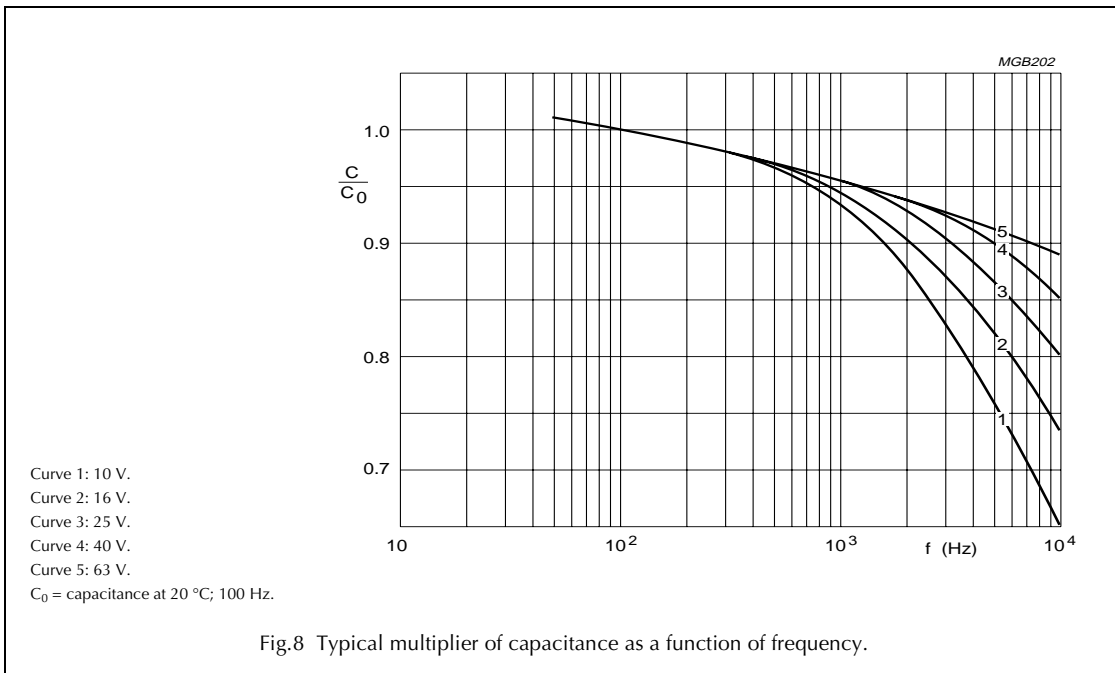

Fig.7 Typical multiplier of capacitance as a function of ambient temperature.

# Aluminum electrolytic capacitors

## Axial Standard Miniature

021 ASM



### Equivalent series resistance (ESR)

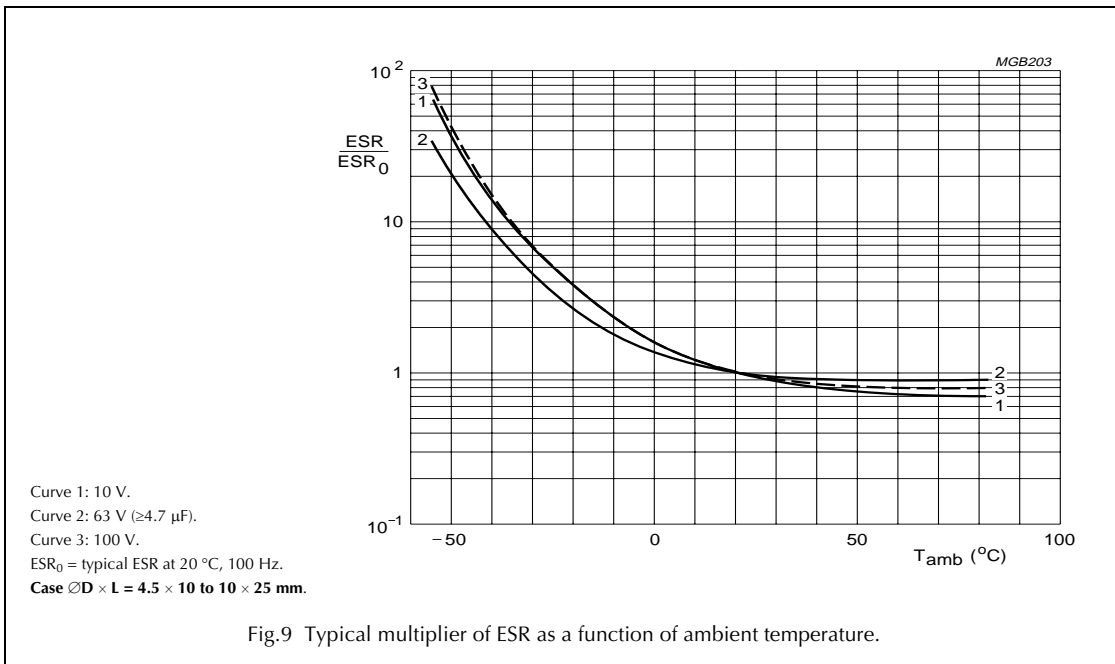

# Aluminum electrolytic capacitors

## Axial Standard Miniature

021 ASM

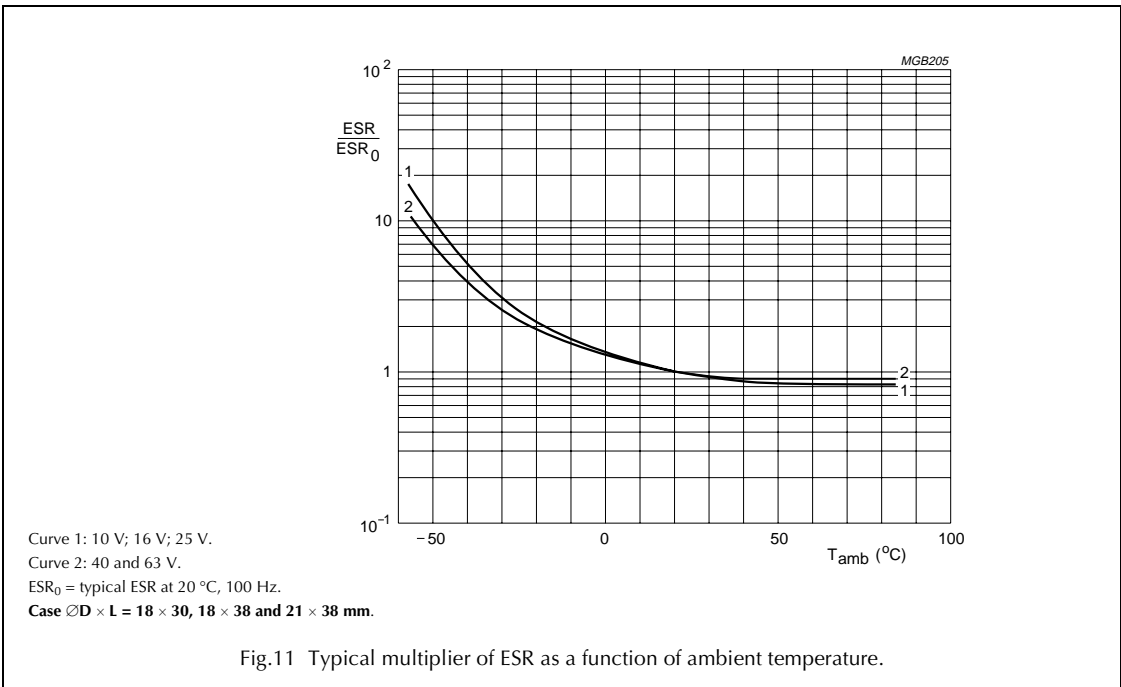
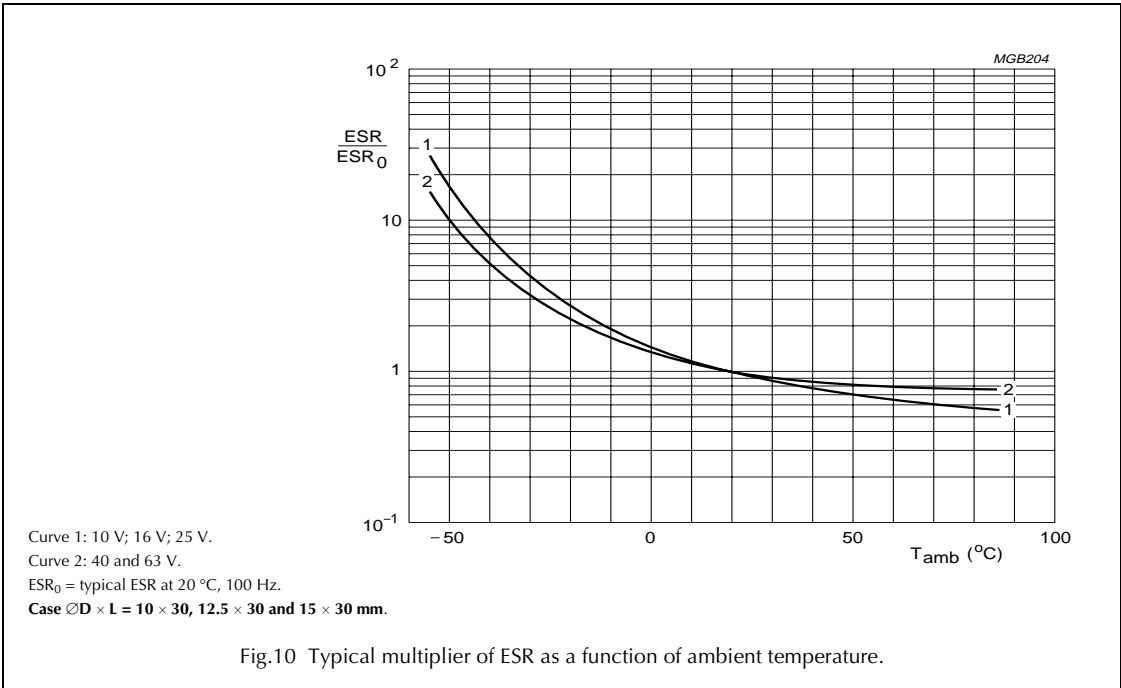

# Aluminum electrolytic capacitors

## Axial Standard Miniature

021 ASM

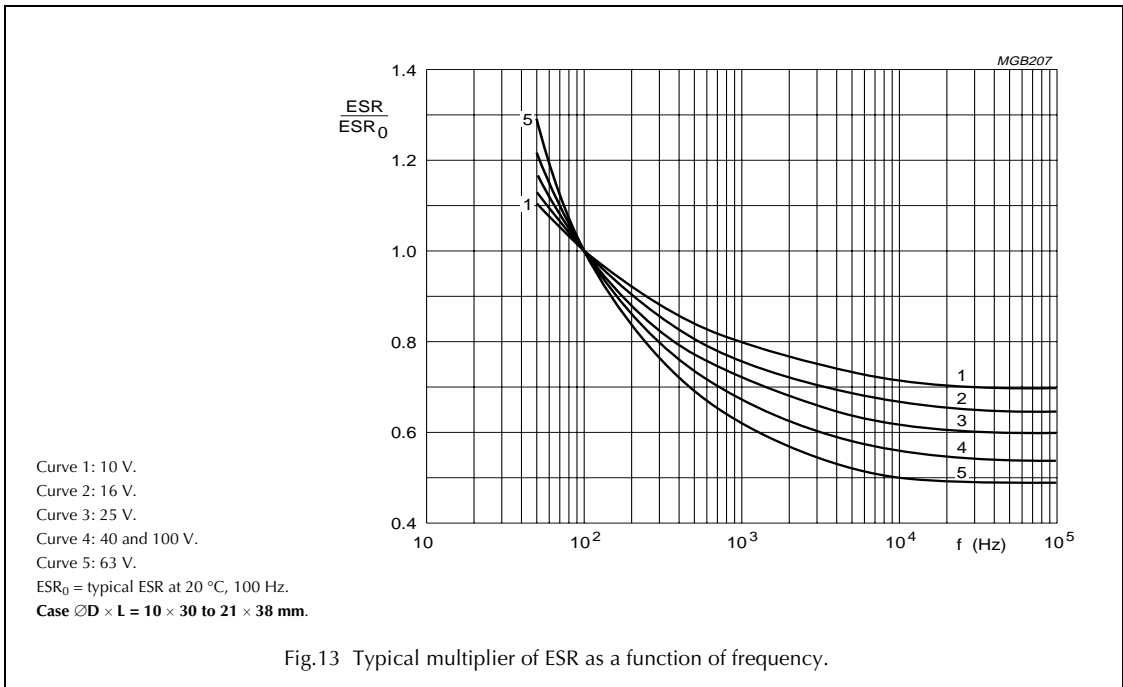
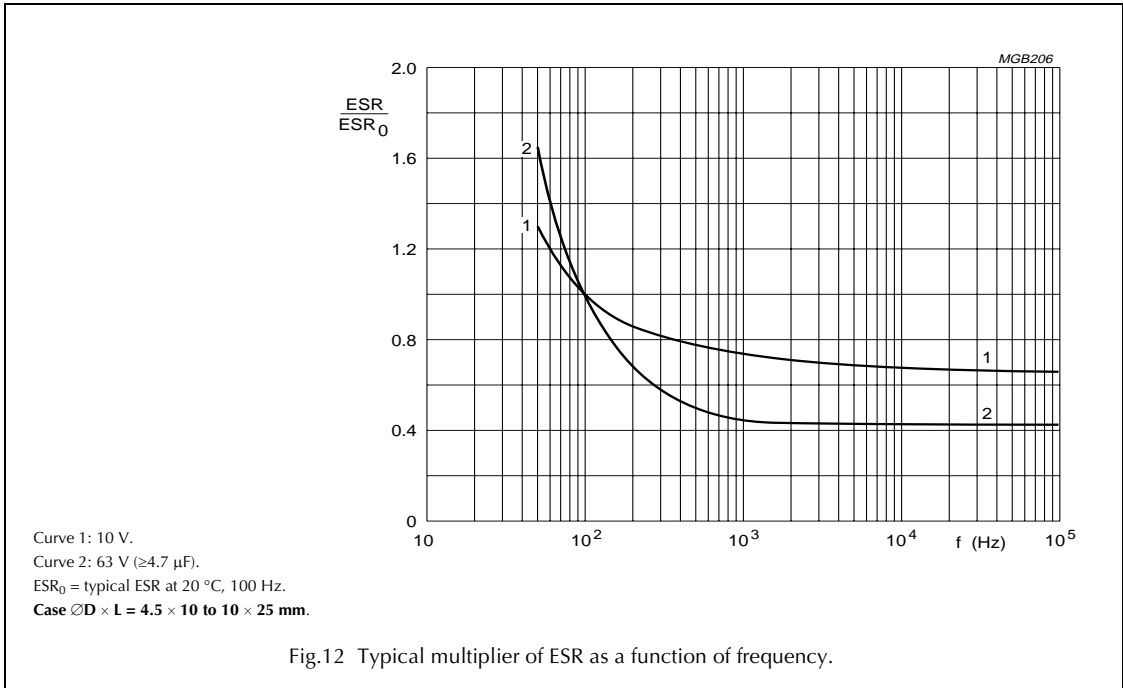

# Aluminum electrolytic capacitors

## Axial Standard Miniature

021 ASM

### Impedance (Z)

**Table 4** Impedance × capacitance values (case  $\varnothing D \times L = 4.5 \times 10$  to  $10 \times 25$  mm)

$T_{amb}$	$Z \times C_R (\Omega \times \mu F)$ at 10 kHz						
	6.3 V	10 V	16 V	25 V	40 V	63 V	100 V
+20 °C	≤300	≤200	≤160	≤120	≤70	≤55	≤90
-25 °C	≤2000	≤1200	≤750	≤560	≤300	≤180	≤600
-40 °C	≤5500	≤3200	≤2000	≤1500	≤900	≤500	≤1600

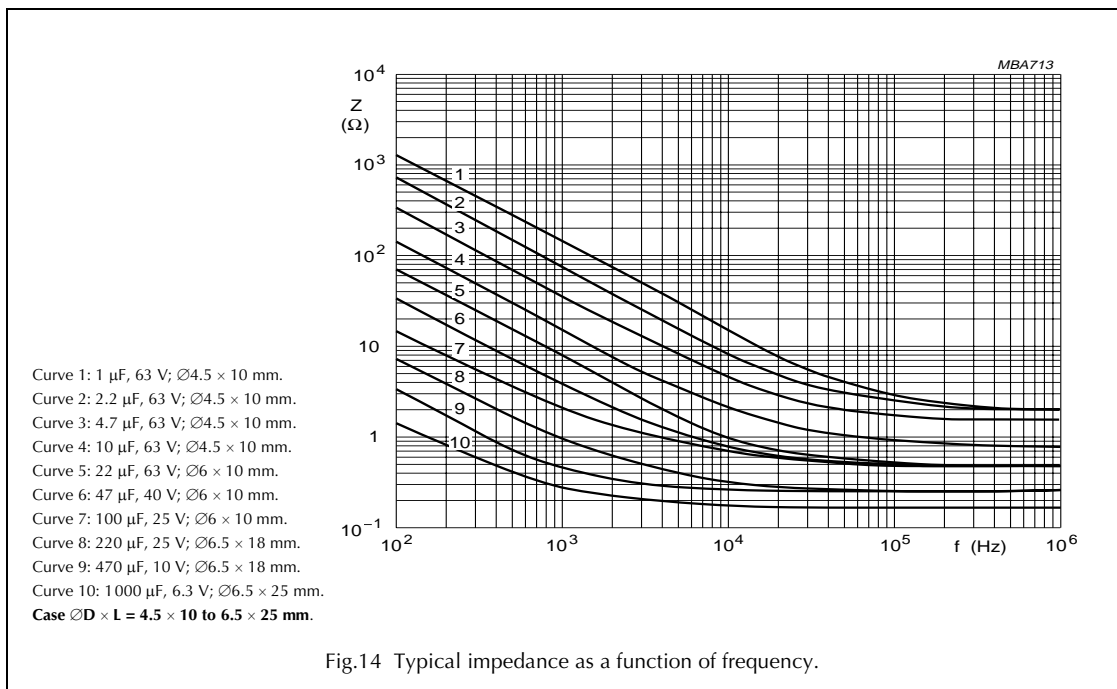

# Aluminum electrolytic capacitors

## Axial Standard Miniature

021 ASM

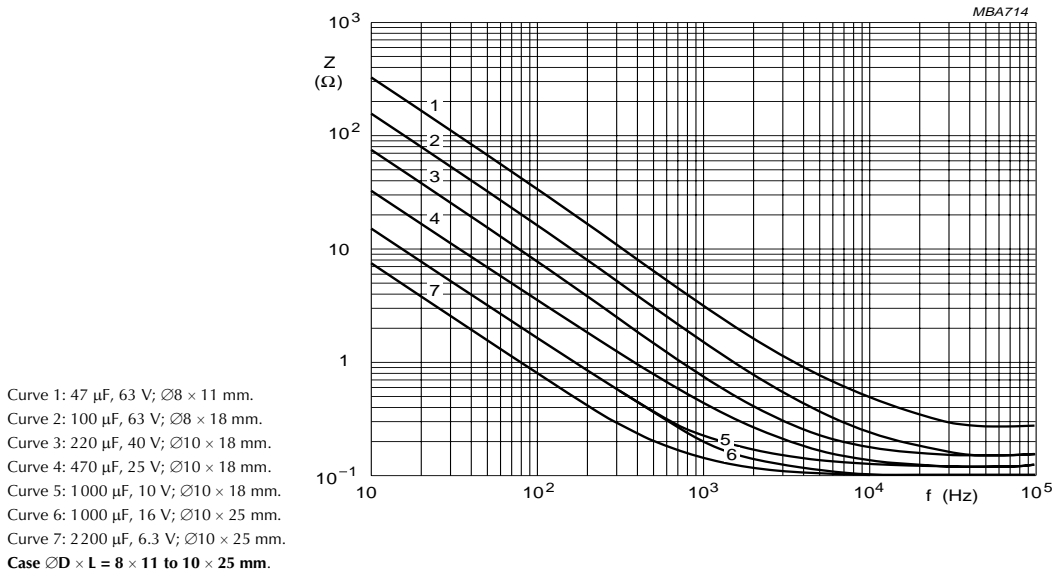

Fig.15 Typical impedance as a function of frequency.

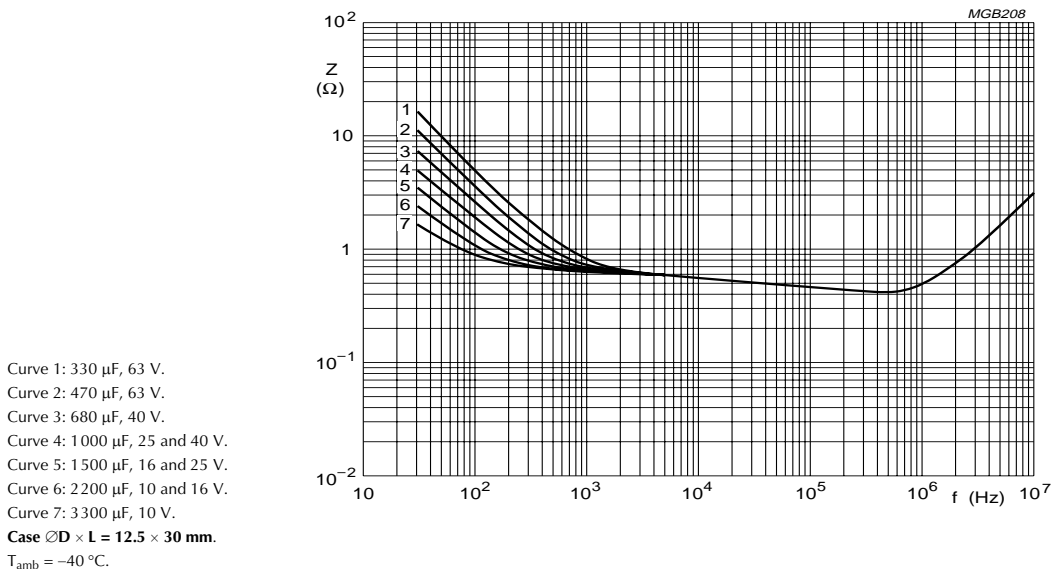
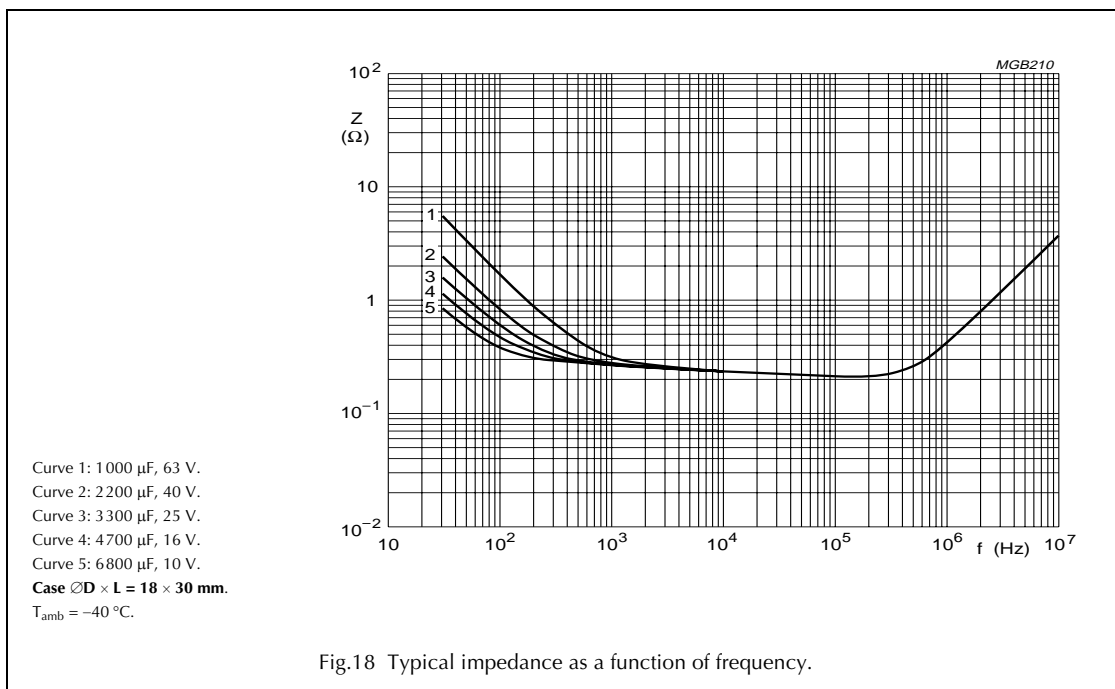
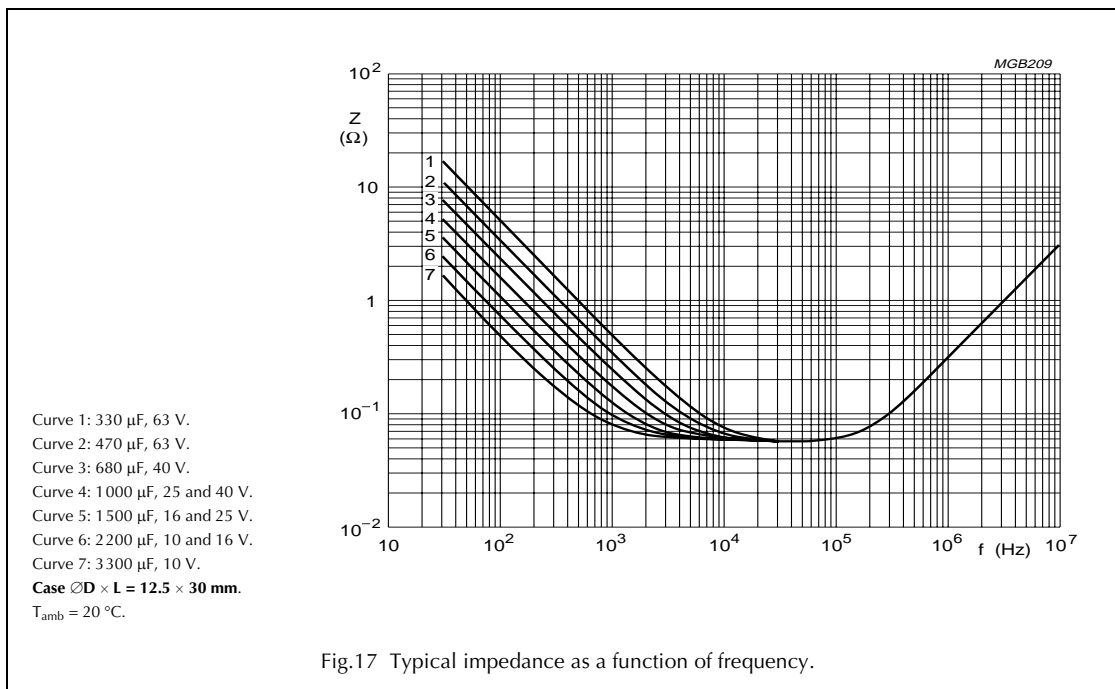

Fig.16 Typical impedance as a function of frequency.

# Aluminum electrolytic capacitors

## Axial Standard Miniature

021 ASM





# Aluminum electrolytic capacitors

## Axial Standard Miniature

021 ASM

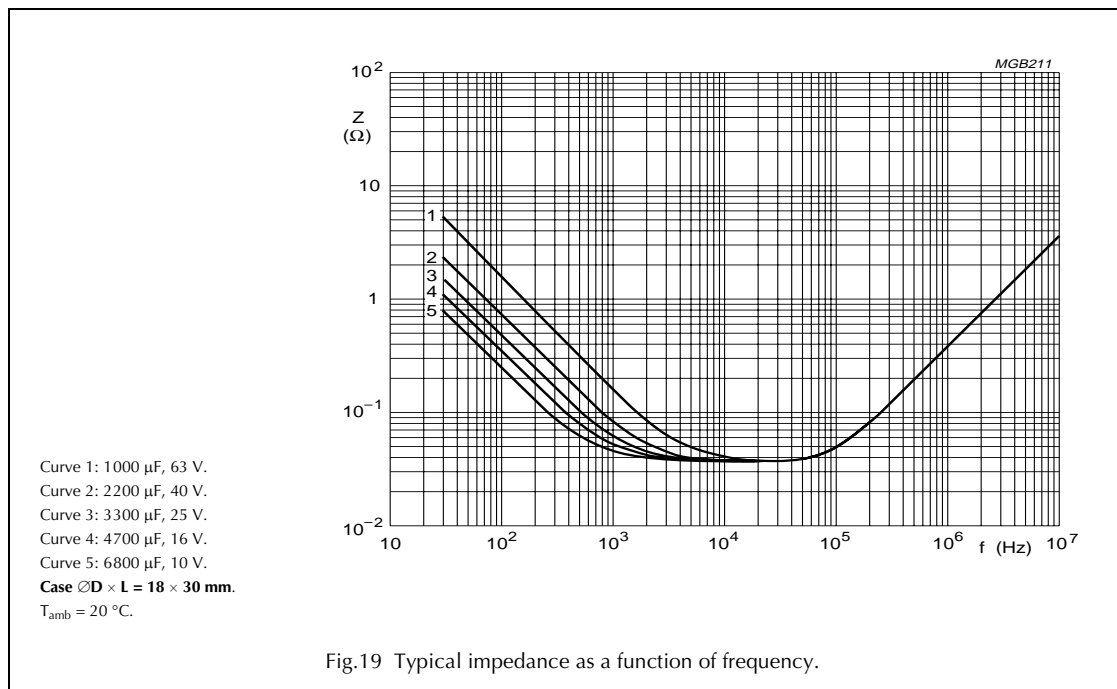

### MARKING

The capacitors are marked (where possible) with the following information:

- Rated capacitance (in  $\mu\text{F}$ )
- Tolerance on nominal capacitance (in accordance with "IEC 60062")
- Rated voltage (in V)
- Group number (021)
- Name of manufacturer
- Date code in accordance with "IEC 60062"
- Code for factory of origin
- Band to indicate the negative terminal
- '+' sign to identify the positive terminal (not for case sizes  $L < 18 \text{ mm}$ ).

# Aluminum electrolytic capacitors

## Axial Standard Miniature

021 ASM

### RIPPLE CURRENT AND USEFUL LIFE

**Table 5** Multiplier of ripple current ( $I_R$ ) as a function of frequency

FREQUENCY (Hz)	$I_R$ MULTIPLIER		
	$U_R = 6.3$ to $16$ V	$U_R = 25$ to $40$ V	$U_R = 63$ to $100$ V
50	0.95	0.9	0.85
100	1	1	1
300	1.07	1.12	1.2
1000	1.12	1.2	1.3
3000	1.15	1.25	1.35
$\geq 10000$	1.2	1.3	1.4

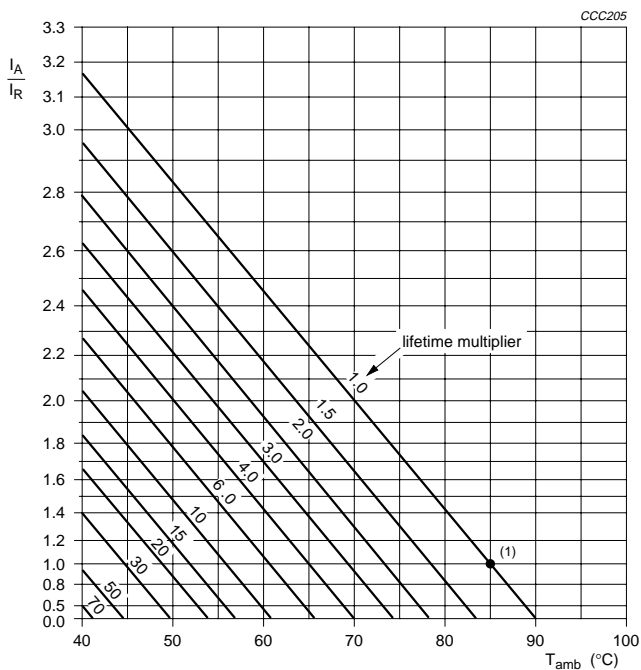

$I_A$  = actual ripple current at 100 Hz.

$I_R$  = rated ripple current at 100 Hz, 85 °C.

(1) Useful life at 85 °C and  $I_R$  applied:

case  $\varnothing D \times L = 4.5 \times 10$  to  $10 \times 25$  mm: 2500 hours

case  $\varnothing D \times L = 10 \times 30$  to  $21 \times 38$  mm: 8000 hours.

Fig.20 Multiplier of useful life as a function of ambient temperature and ripple current load.

# Aluminum electrolytic capacitors

## Axial Standard Miniature

021 ASM

### SPECIFIC TESTS AND REQUIREMENTS

General tests and requirements are specified in data handbook BC01, section "Tests and Requirements".

**Table 6** Test procedures and requirements

TEST		PROCEDURE (quick reference)	REQUIREMENTS
NAME OF TEST	REFERENCE		
Endurance	IEC 60384-4/ EN130300 subclause 4.13	$T_{amb} = 85\text{ }^{\circ}\text{C}$ ; $U_R$ applied; case $\varnothing D \times L = 4.5 \times 10$ to $10 \times 25$ mm: $U_R = 6.3$ to $25$ V: 1000 hours; $U_R = 40$ to $100$ V: 2000 hours; case $\varnothing D \times L = 10 \times 30$ to $21 \times 38$ mm: $U_R = 6.3$ to $100$ V: 5000 hours	$U_R \leq 6.3$ V; $\Delta C/C$ : +15/-30% $U_R > 6.3$ V; $\Delta C/C$ : $\pm 15\%$ $\tan \delta \leq 1.3 \times$ spec. limit $Z \leq 2 \times$ spec. limit $I_{L5} \leq$ spec. limit
		$T_{amb} = 105\text{ }^{\circ}\text{C}$ ; $U_R$ applied; case $\varnothing D \times L = 10 \times 30$ to $21 \times 38$ mm: 1500 hours	$\Delta C/C$ : $\leq \pm 15\%$ $\tan \delta \leq 1.6 \times$ spec. limit $Z \leq 2 \times$ spec. limit $I_{L5} \leq$ spec. limit
Useful life	CECC 30301 subclause 1.8.1	$T_{amb} = 85\text{ }^{\circ}\text{C}$ ; $U_R$ and $I_R$ applied; case $\varnothing D \times L = 4.5 \times 10$ to $10 \times 25$ mm: 2500 hours; case $\varnothing D \times L = 10 \times 30$ to $21 \times 38$ mm: 8000 hours	$U_R \leq 6.3$ V; $\Delta C/C$ : +45/-50% $U_R > 6.3$ V; $\Delta C/C$ : $\pm 45\%$ $\tan \delta \leq 3 \times$ spec. limit $Z \leq 3 \times$ spec. limit $I_{L5} \leq$ spec. limit no short or open circuit total failure percentage: $\leq 1\%$
Shelf life (storage at high temperature)	IEC 60384-4/ EN130300 subclause 4.17	$T_{amb} = 85\text{ }^{\circ}\text{C}$ ; no voltage applied; 500 hours after test: $U_R$ to be applied for 30 minutes, 24 to 48 hours before measurement	$\Delta C/C$ , $\tan \delta$ , $Z$ : for requirements see 'Endurance test' above $I_{L5} \leq 2 \times$ spec. limit