

Order code	Manufacturer code	Description
47-3474	MMUN2111LT1G	MMUN2111LT1G B/R TRANSISTOR PNP RC

	Page 1 of 14
The enclosed information is believed to be correct, Information may change without notice due to product improvement. Users should ensure that the product is suitable for their use. E. & O. E.	Revision A 20/02/2007

MMUN2111LT1 Series

Preferred Devices

Bias Resistor Transistors

PNP Silicon Surface Mount Transistors with Monolithic Bias Resistor Network

This new series of digital transistors is designed to replace a single device and its external resistor bias network. The BRT (Bias Resistor Transistor) contains a single transistor with a monolithic bias network consisting of two resistors; a series base resistor and a base-emitter resistor. The BRT eliminates these individual components by integrating them into a single device. The use of a BRT can reduce both system cost and board space. The device is housed in the SOT-23 package which is designed for low power surface mount applications.

Features

- Simplifies Circuit Design
- Reduces Board Space
- Reduces Component Count
- The SOT-23 package can be soldered using wave or reflow. The modified gull-winged leads absorb thermal stress during soldering eliminating the possibility of damage to the die.
- Available in 8 mm embossed tape and reel.
- Pb-Free Packages are Available

MAXIMUM RATINGS ($T_A = 25^\circ\text{C}$ unless otherwise noted)

Rating	Symbol	Value	Unit
Collector-Base Voltage	V_{CBO}	50	Vdc
Collector-Emitter Voltage	V_{CEO}	50	Vdc
Collector Current	I_C	100	mAdc

THERMAL CHARACTERISTICS

Characteristic	Symbol	Max	Unit
Total Device Dissipation $T_A = 25^\circ\text{C}$ Derate above 25°C	P_D	246 (Note 1) 400 (Note 2) 1.5 (Note 1) 2.0 (Note 2)	mW $^\circ\text{C}/\text{W}$
Thermal Resistance, Junction-to-Ambient	$R_{\theta JA}$	508 (Note 1) 311 (Note 2)	$^\circ\text{C}/\text{W}$
Thermal Resistance, Junction-to-Lead	$R_{\theta JL}$	174 (Note 1) 208 (Note 2)	$^\circ\text{C}/\text{W}$
Junction and Storage, Temperature Range	T_J, T_{stg}	-55 to +150	$^\circ\text{C}$

Stresses exceeding Maximum Ratings may damage the device. Maximum Ratings are stress ratings only. Functional operation above the Recommended Operating Conditions is not implied. Extended exposure to stresses above the Recommended Operating Conditions may affect device reliability.

1. FR-4 @ Minimum Pad
2. FR-4 @ 1.0 x 1.0 inch Pad



ON Semiconductor®

<http://onsemi.com>

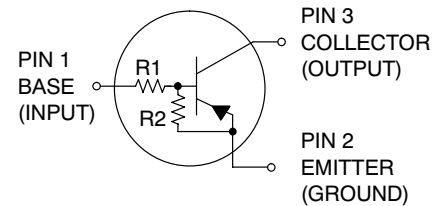

MARKING DIAGRAM

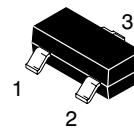

SOT-23
CASE 318
STYLE 6

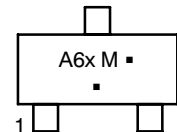

A6x = Device Code
x = A - L (Refer to page 2)
M = Date Code*
▪ = Pb-Free Package

(Note: Microdot may be in either location)

*Date Code orientation may vary depending upon manufacturing location.

ORDERING INFORMATION

Device	Package	Shipping†
MMUN21xxLT1	SOT-23	3000/Tape & Reel
MMUN21xxLT1G	SOT-23 (Pb-Free)	3000/Tape & Reel
MMUN21xxLT3	SOT-23	10000/Tape & Reel
MMUN21xxLT3G	SOT-23 (Pb-Free)	10000/Tape & Reel

†For information on tape and reel specifications, including part orientation and tape sizes, please refer to our Tape and Reel Packaging Specifications Brochure, BRD8011/D.

DEVICE MARKING INFORMATION

See specific marking information in the device marking table on page 2 of this data sheet.

Preferred devices are recommended choices for future use and best overall value.

MMUN2111LT1 Series

DEVICE MARKING AND RESISTOR VALUES

Device*	Package	Marking	R1 (K)	R2 (K)	Shipping
MMUN2111LT1, G MMUN2111LT3, G	SOT-23	A6A	10	10	3000/Tape & Reel 10,000/Tape & Reel
MMUN2112LT1, G	SOT-23	A6B	22	22	3000/Tape & Reel
MMUN2113LT1, G MMUN2113LT3, G	SOT-23	A6C	47	47	3000/Tape & Reel 10,000/Tape & Reel
MMUN2114LT1, G	SOT-23	A6D	10	47	3000/Tape & Reel
MMUN2115LT1, G	SOT-23	A6E	10	∞	3000/Tape & Reel
MMUN2116LT1, G	SOT-23	A6F	4.7	∞	3000/Tape & Reel
MMUN2130LT1, G (Note 3)	SOT-23	A6G	1.0	1.0	3000/Tape & Reel
MMUN2131LT1, G (Note 3)	SOT-23	A6H	2.2	2.2	3000/Tape & Reel
MMUN2132LT1, G	SOT-23	A6J	4.7	4.7	3000/Tape & Reel
MMUN2133LT1, G	SOT-23	A6K	4.7	47	3000/Tape & Reel
MMUN2134LT1, G (Note 3)	SOT-23	A6L	22	47	3000/Tape & Reel

*The "G" suffix indicates Pb-Free package available.

3. New devices. Updated curves to follow in subsequent data sheets.

ELECTRICAL CHARACTERISTICS ($T_A = 25^\circ\text{C}$ unless otherwise noted)

Characteristic	Symbol	Min	Typ	Max	Unit
OFF CHARACTERISTICS					
Collector-Base Cutoff Current ($V_{CB} = 50\text{ V}$, $I_E = 0$)	I_{CBO}	-	-	100	nAdc
Collector-Emitter Cutoff Current ($V_{CE} = 50\text{ V}$, $I_B = 0$)	I_{CEO}	-	-	500	nAdc
Emitter-Base Cutoff Current ($V_{EB} = 6.0\text{ V}$, $I_C = 0$)	I_{EBO}	-	-	0.5	mAdc
	MMUN2111LT1, G	-	-	0.2	
	MMUN2112LT1, G	-	-	0.1	
	MMUN2113LT1, G	-	-	0.2	
	MMUN2114LT1, G	-	-	0.9	
	MMUN2115LT1, G	-	-	1.9	
	MMUN2116LT1, G	-	-	4.3	
	MMUN2130LT1, G	-	-	2.3	
	MMUN2131LT1, G	-	-	1.5	
	MMUN2132LT1, G	-	-	0.18	
	MMUN2133LT1, G	-	-	0.13	
	MMUN2134LT1, G	-	-		
Collector-Base Breakdown Voltage ($I_C = 10\ \mu\text{A}$, $I_E = 0$)	$V_{(BR)CBO}$	50	-	-	Vdc
Collector-Emitter Breakdown Voltage (Note 4) ($I_C = 2.0\text{ mA}$, $I_B = 0$)	$V_{(BR)CEO}$	50	-	-	Vdc

4. Pulse Test: Pulse Width < 300 μs , Duty Cycle < 2.0%

MMUN2111LT1 Series

ELECTRICAL CHARACTERISTICS ($T_A = 25^\circ\text{C}$ unless otherwise noted) (Continued)

Characteristic	Symbol	Min	Typ	Max	Unit	
ON CHARACTERISTICS (Note 5)						
DC Current Gain ($V_{CE} = 10\text{ V}$, $I_C = 5.0\text{ mA}$)	MMUN2111LT1, G MMUN2112LT1, G MMUN2113LT1, G MMUN2114LT1, G MMUN2115LT1, G MMUN2116LT1, G MMUN2130LT1, G MMUN2131LT1, G MMUN2132LT1, G MMUN2133LT1, G MMUN2134LT1, G	h _{FE}	35 60 80 80 160 160 3.0 8.0 15 80 80	60 100 140 140 250 250 5.0 15 27 140 130	- - - - - - - - - - -	
Collector-Emitter Saturation Voltage ($I_C = 10\text{ mA}$, $I_B = 0.3\text{ mA}$) ($I_C = 10\text{ mA}$, $I_B = 5\text{ mA}$) ($I_C = 10\text{ mA}$, $I_B = 1\text{ mA}$)	MMUN2111LT1, G MMUN2112LT1, G MMUN2113LT1, G MMUN2114LT1, G MMUN2133LT1, G MMUN2130LT1, G MMUN2131LT1, G MMUN2115LT1, G MMUN2116LT1, G MMUN2132LT1, G MMUN2134LT1, G	$V_{CE(sat)}$	- - - - - - - - - - -	- - - - - - - - - - -	0.25 0.25 0.25 0.25 0.25 0.25 0.25 0.25 0.25 0.25 0.25	Vdc
Output Voltage (on) ($V_{CC} = 5.0\text{ V}$, $V_B = 2.5\text{ V}$, $R_L = 1.0\text{ k}\Omega$) ($V_{CC} = 5.0\text{ V}$, $V_B = 3.5\text{ V}$, $R_L = 1.0\text{ k}\Omega$)	MMUN2111LT1, G MMUN2112LT1, G MMUN2114LT1, G MMUN2115LT1, G MMUN2116LT1, G MMUN2130LT1, G MMUN2131LT1, G MMUN2132LT1, G MMUN2133LT1, G MMUN2134LT1, G MMUN2113LT1, G	V_{OL}	- - - - - - - - - - -	- - - - - - - - - - -	0.2 0.2 0.2 0.2 0.2 0.2 0.2 0.2 0.2 0.2 0.2	Vdc
Output Voltage (off) ($V_{CC} = 5.0\text{ V}$, $V_B = 0.5\text{ V}$, $R_L = 1.0\text{ k}\Omega$) ($V_{CC} = 5.0\text{ V}$, $V_B = 0.25\text{ V}$, $R_L = 1.0\text{ k}\Omega$) ($V_{CC} = 5.0\text{ V}$, $V_B = 0.050\text{ V}$, $R_L = 1.0\text{ k}\Omega$)	MMUN2111LT1, G MMUN2112LT1, G MMUN2113LT1, G MMUN2114LT1, G MMUN2133LT1, G MMUN2134LT1, G MMUN2115LT1, G MMUN2116LT1, G MMUN2131LT1, G MMUN2132LT1, G MMUN2130LT1, G	V_{OH}	4.9 4.9 4.9 4.9 4.9 4.9 4.9 4.9 4.9 4.9 4.9	- - - - - - - - - - -	- - - - - - - - - - -	Vdc

MMUN2111LT1 Series

ELECTRICAL CHARACTERISTICS ($T_A = 25^\circ\text{C}$ unless otherwise noted) (Continued)

Characteristic		Symbol	Min	Typ	Max	Unit
ON CHARACTERISTICS (Note 5)						
Input Resistor	MMUN2111LT1, G	R1	7.0	10	13	k Ω
	MMUN2112LT1, G		15.4	22	28.6	
	MMUN2113LT1, G		32.9	47	61.1	
	MMUN2114LT1, G		7.0	10	13	
	MMUN2115LT1, G		7.0	10	13	
	MMUN2116LT1, G		3.3	4.7	6.1	
	MMUN2130LT1, G		0.7	1.0	1.3	
	MMUN2131LT1, G		1.5	2.2	2.9	
	MMUN2132LT1, G		3.3	4.7	6.1	
	MMUN2133LT1, G		3.3	4.7	6.1	
	MMUN2134LT1, G		15.4	22	28.6	
Resistor Ratio	MMUN2111LT1, G	R ₁ /R ₂	0.8	1.0	1.2	
	MMUN2112LT1, G		0.8	1.0	1.2	
	MMUN2113LT1, G		0.8	1.0	1.2	
	MMUN2114LT1, G		0.17	0.21	0.25	
	MMUN2115LT1, G		-	-	-	
	MMUN2116LT1, G		-	-	-	
	MMUN2130LT1, G		0.8	1.0	1.2	
	MMUN2131LT1, G		0.8	1.0	1.2	
	MMUN2132LT1, G		0.8	1.0	1.2	
	MMUN2133LT1, G		0.055	0.1	0.185	
	MMUN2134LT1, G		0.38	0.47	0.56	

5. Pulse Test: Pulse Width < 300 μs , Duty Cycle < 2.0%

MMUN2111LT1 Series

TYPICAL ELECTRICAL CHARACTERISTICS MMUN2111LT1

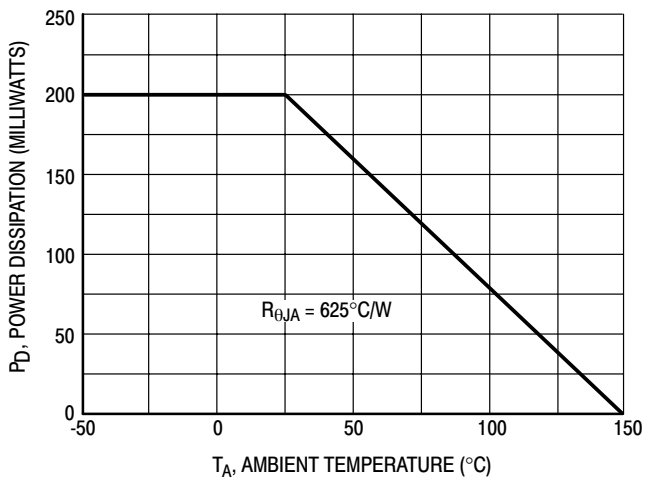

Figure 1. Derating Curve

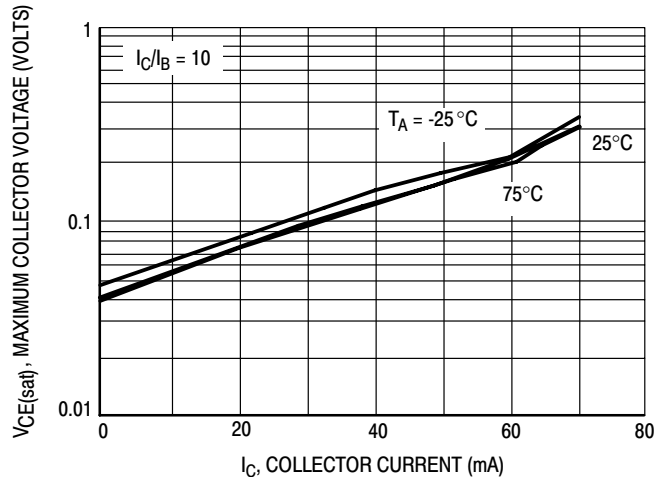

Figure 2. $V_{CE(sat)}$ versus I_C

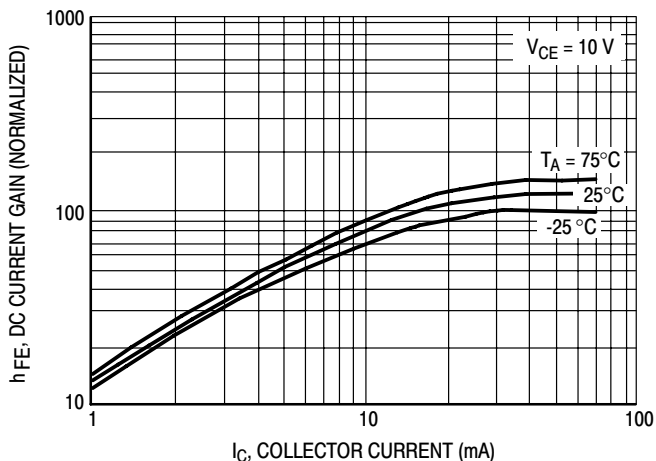

Figure 3. DC Current Gain

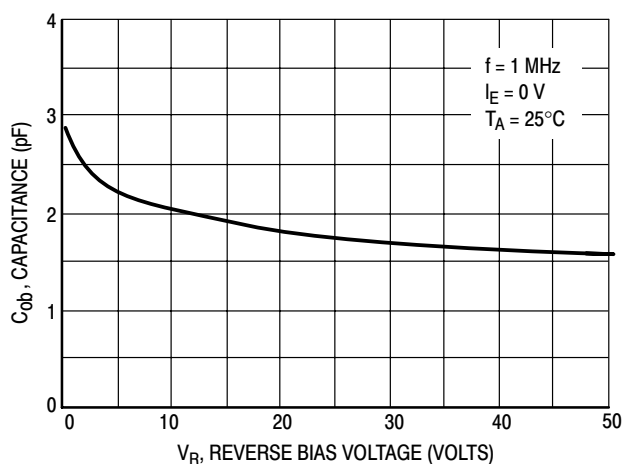

Figure 4. Output Capacitance

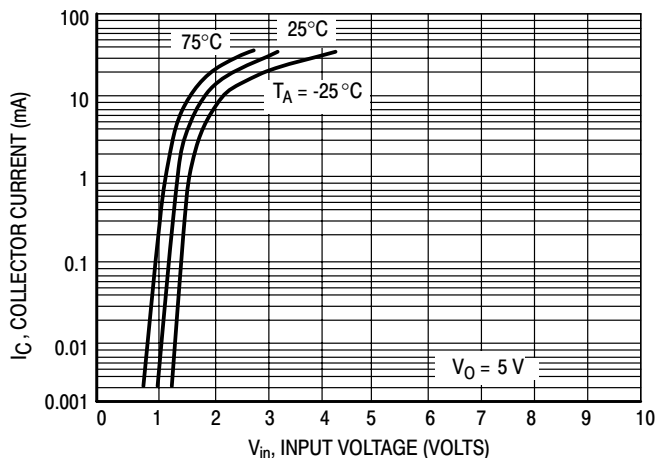

Figure 5. Output Current versus Input Voltage

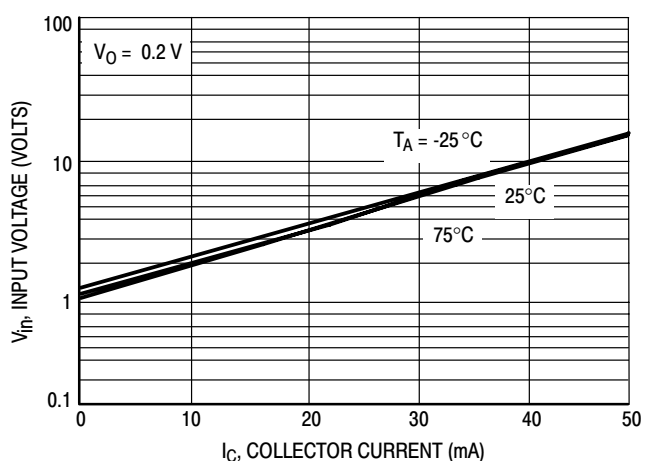

Figure 6. Input Voltage versus Output Current

MMUN2111LT1 Series

TYPICAL ELECTRICAL CHARACTERISTICS MMUN2112LT1

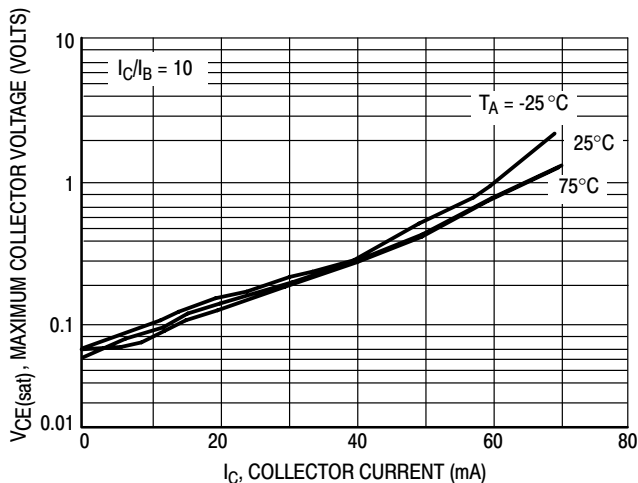

Figure 7. $V_{CE(sat)}$ versus I_C

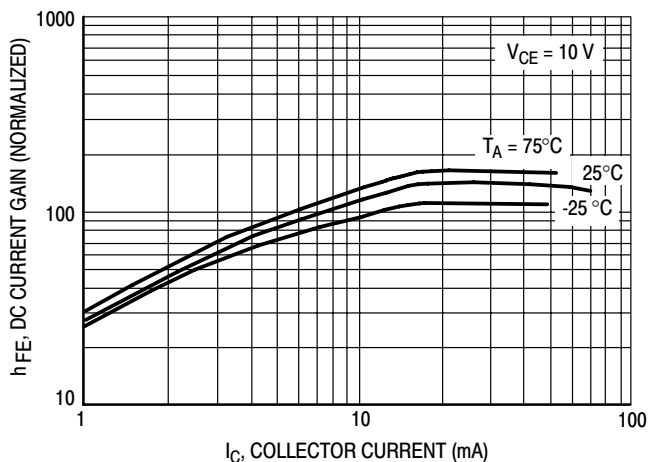

Figure 8. DC Current Gain

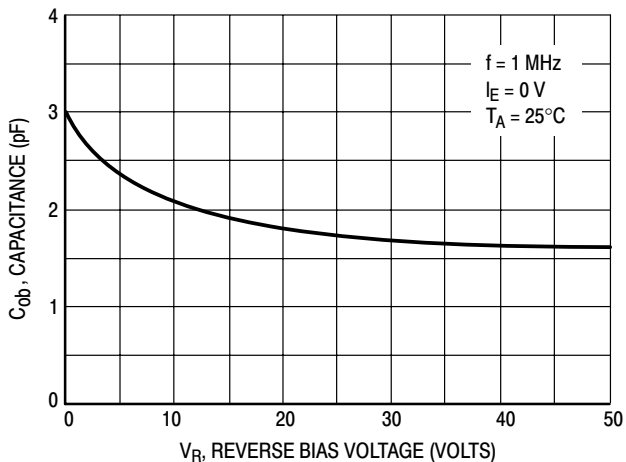

Figure 9. Output Capacitance

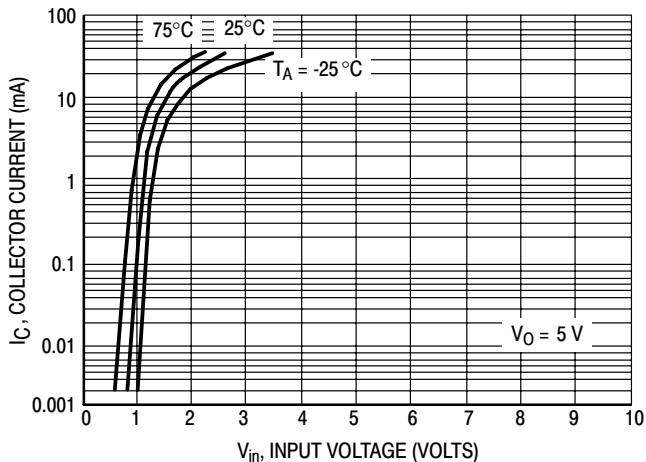

Figure 10. Output Current versus Input Voltage

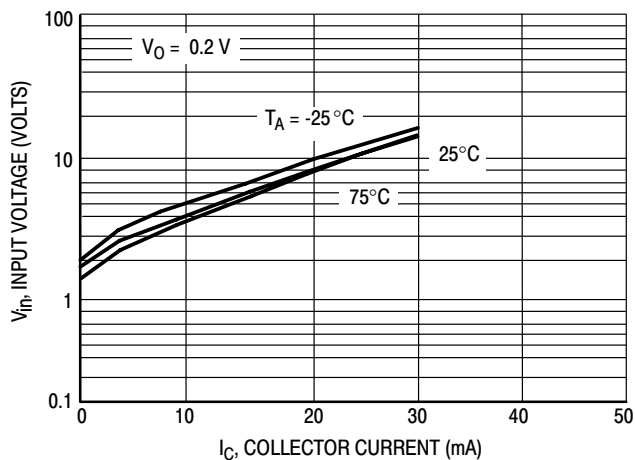

Figure 11. Input Voltage versus Output Current

MMUN2111LT1 Series

TYPICAL ELECTRICAL CHARACTERISTICS MMUN2113LT1

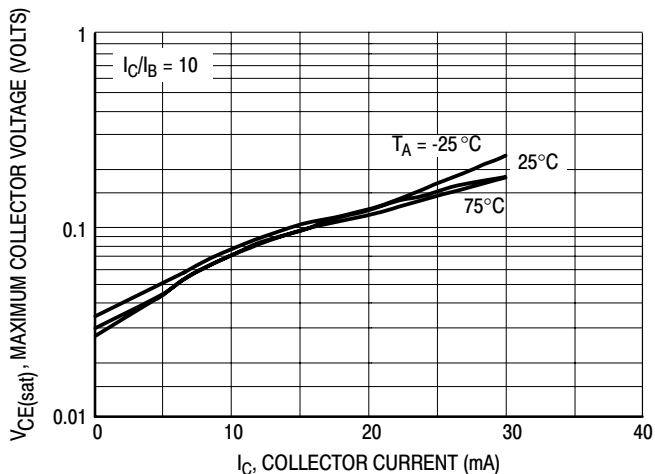

Figure 12. $V_{CE(sat)}$ versus I_C

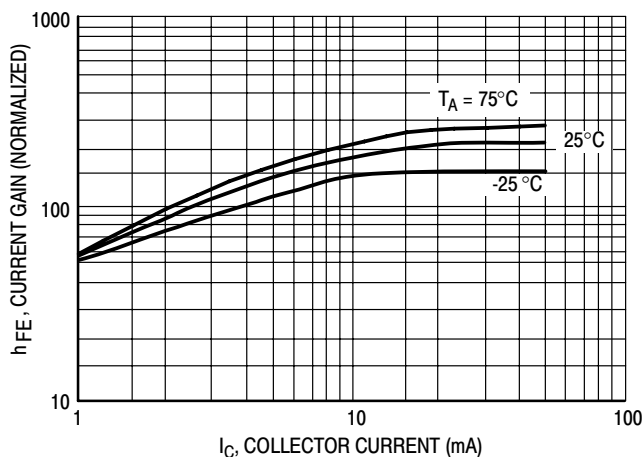

Figure 13. DC Current Gain

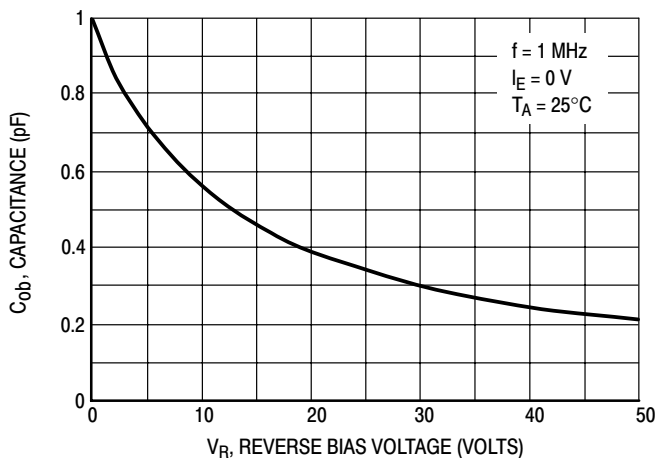

Figure 14. Output Capacitance

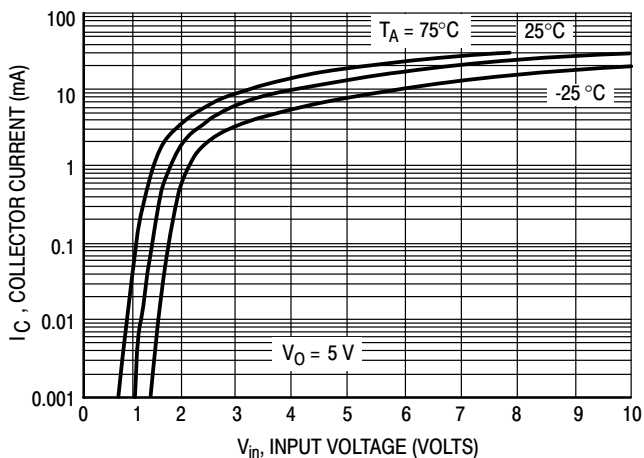

Figure 15. Output Current versus Input Voltage

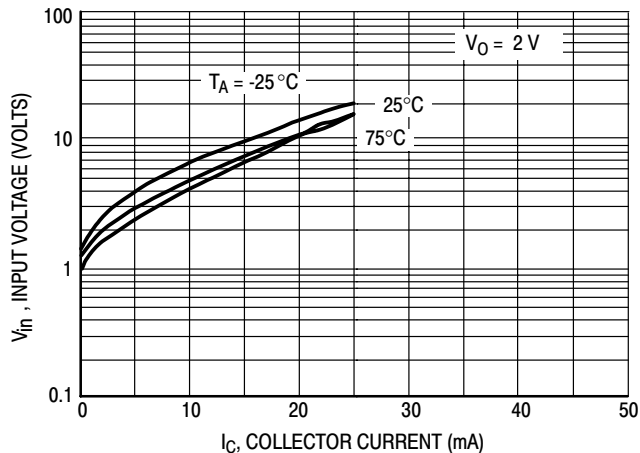

Figure 16. Input Voltage versus Output Current

MMUN2111LT1 Series

TYPICAL ELECTRICAL CHARACTERISTICS MMUN2114LT1

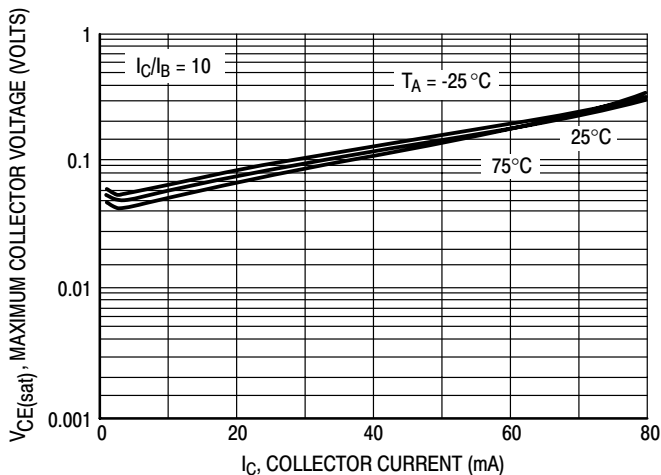

Figure 17. $V_{CE(sat)}$ versus I_C

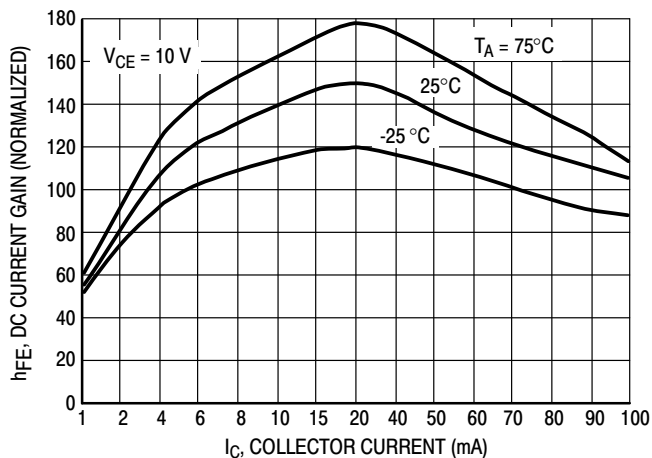

Figure 18. DC Current Gain

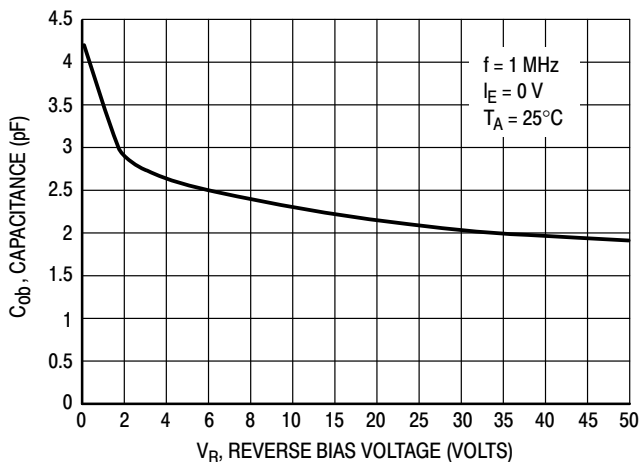

Figure 19. Output Capacitance

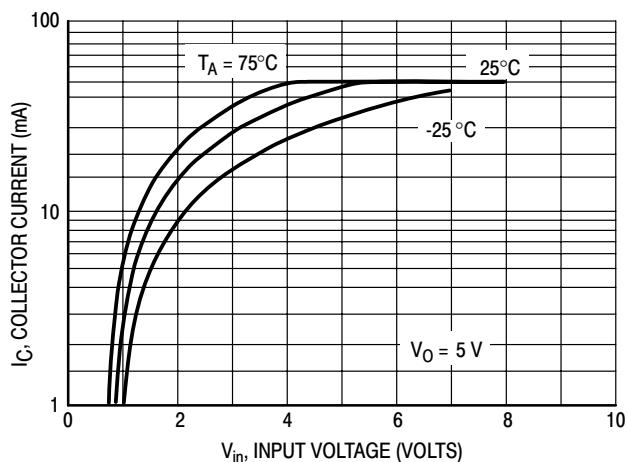

Figure 20. Output Current versus Input Voltage

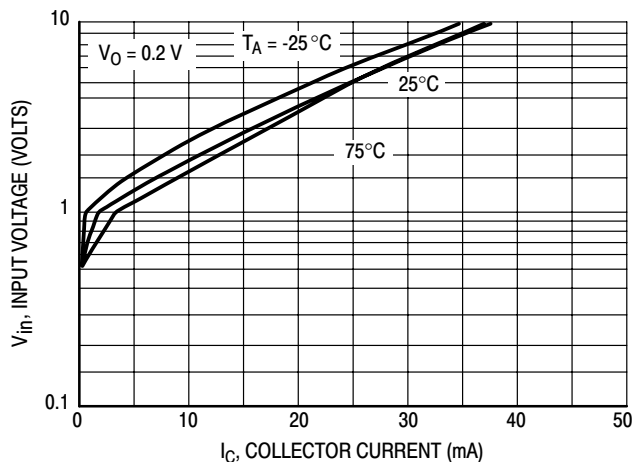

Figure 21. Input Voltage versus Output Current

MMUN2111LT1 Series

TYPICAL ELECTRICAL CHARACTERISTICS MMUN2115LT1

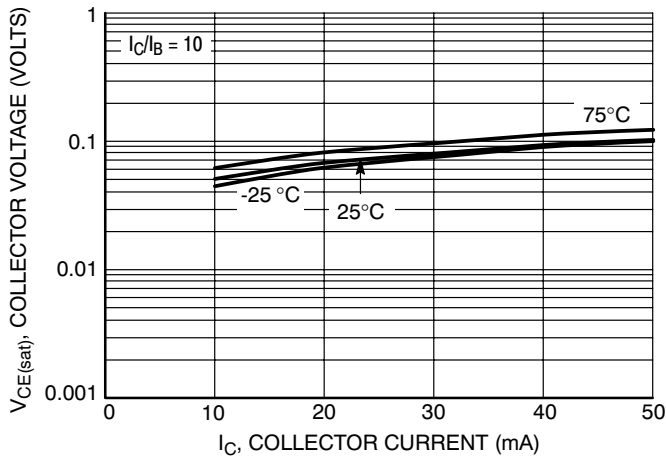

Figure 22. $V_{CE(sat)}$ versus I_C

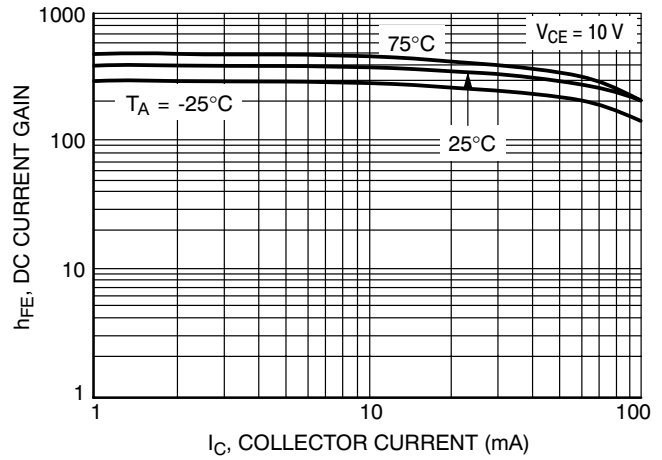

Figure 23. DC Current Gain

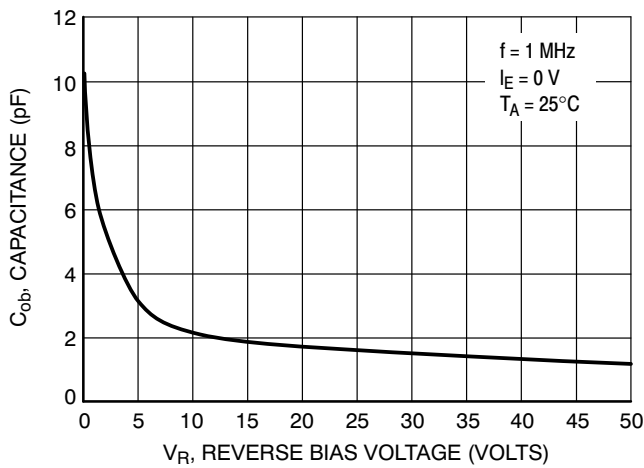

Figure 24. Output Capacitance

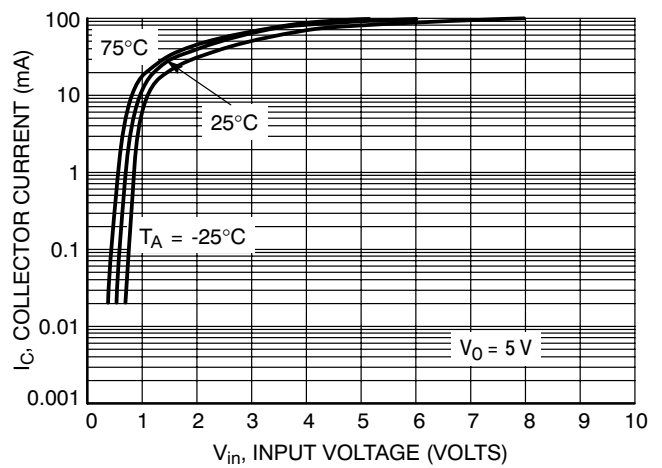

Figure 25. Output Current versus Input Voltage

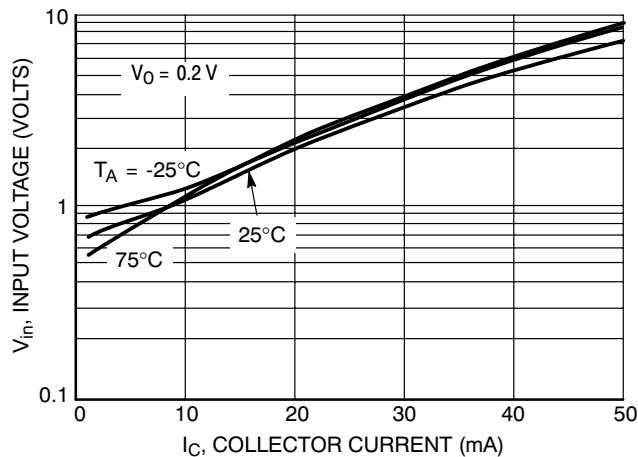

Figure 26. Input Voltage versus Output Current

MMUN2111LT1 Series

TYPICAL ELECTRICAL CHARACTERISTICS MMUN2116LT1

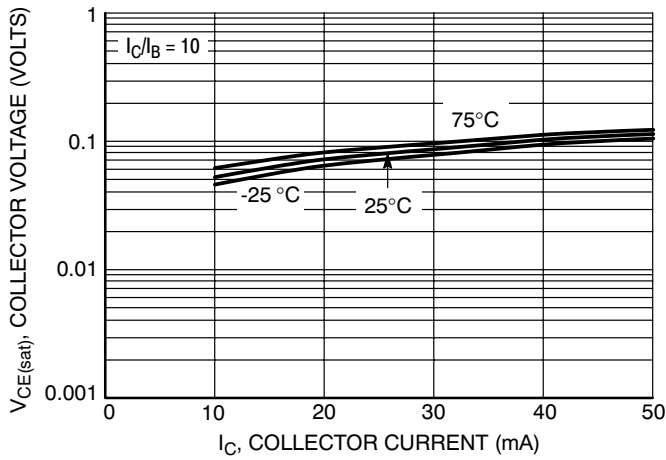

Figure 27. $V_{CE(sat)}$ versus I_C

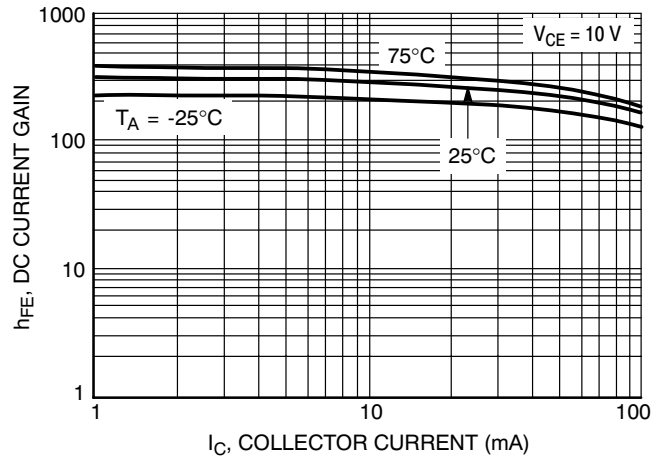

Figure 28. DC Current Gain

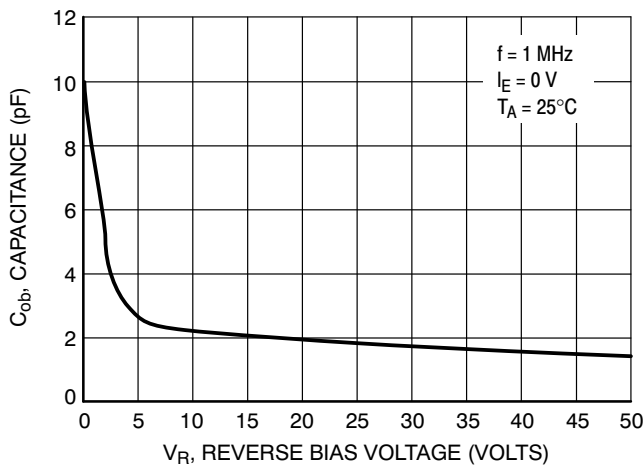

Figure 29. Output Capacitance

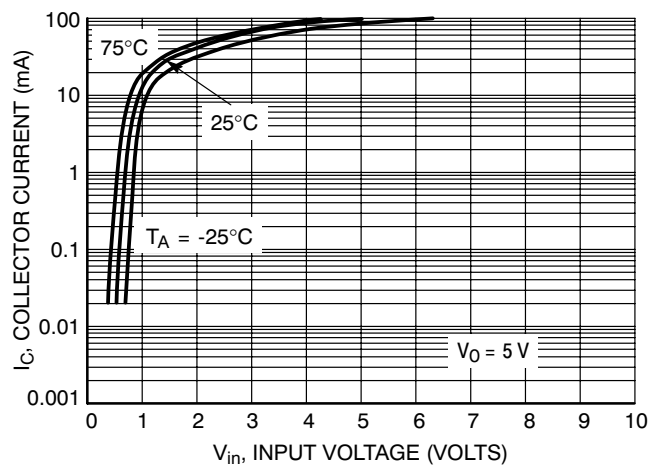

Figure 30. Output Current versus Input Voltage

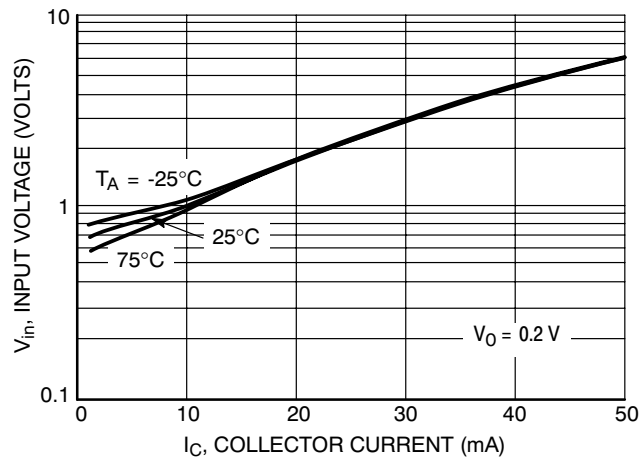

Figure 31. Input Voltage versus Output Current

MMUN2111LT1 Series

TYPICAL ELECTRICAL CHARACTERISTICS MMUN2132LT1

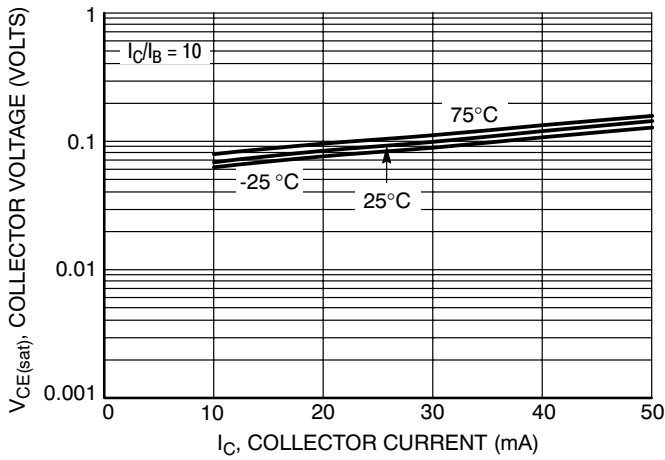

Figure 32. $V_{CE(sat)}$ versus I_C

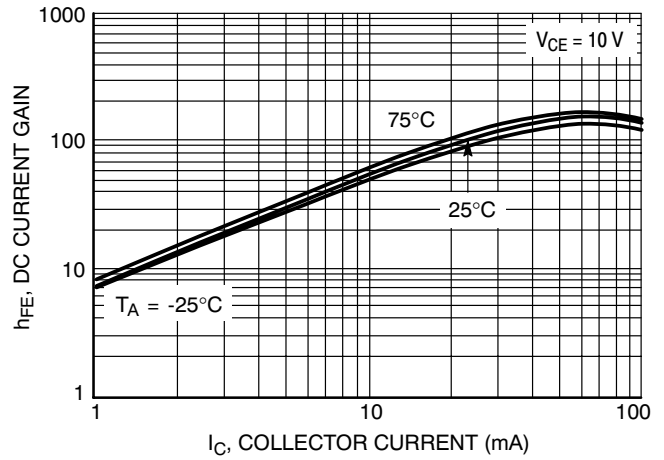

Figure 33. DC Current Gain

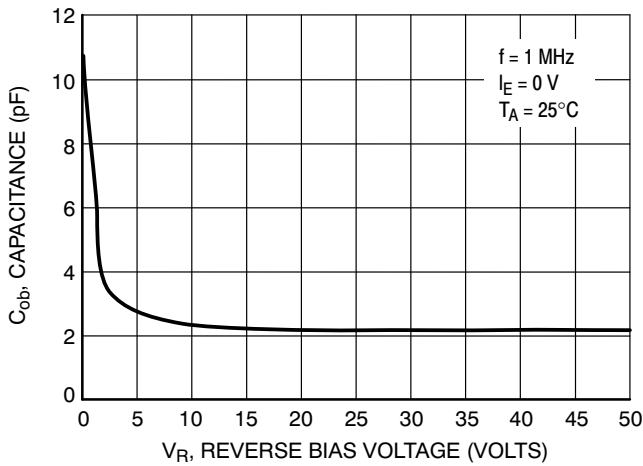

Figure 34. Output Capacitance

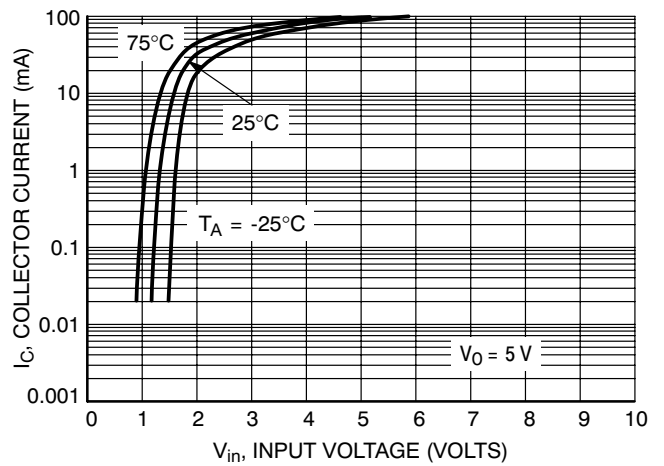

Figure 35. Output Current versus Input Voltage

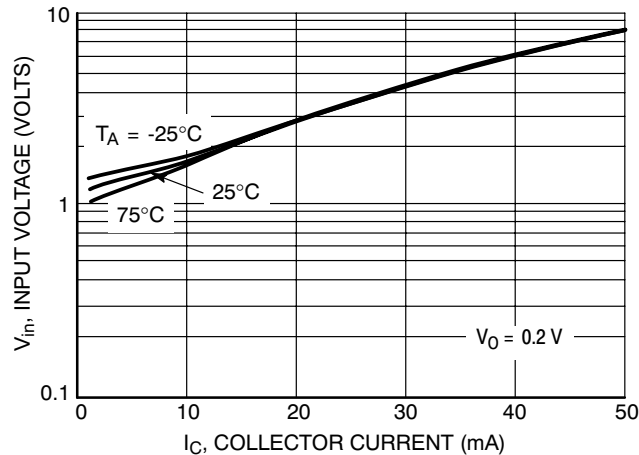

Figure 36. Input Voltage versus Output Current

MMUN2111LT1 Series

TYPICAL ELECTRICAL CHARACTERISTICS MMUN2133LT1

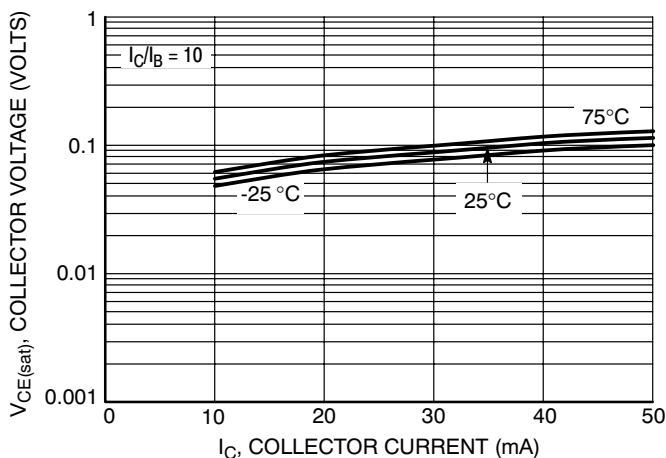

Figure 37. $V_{CE(sat)}$ versus I_C

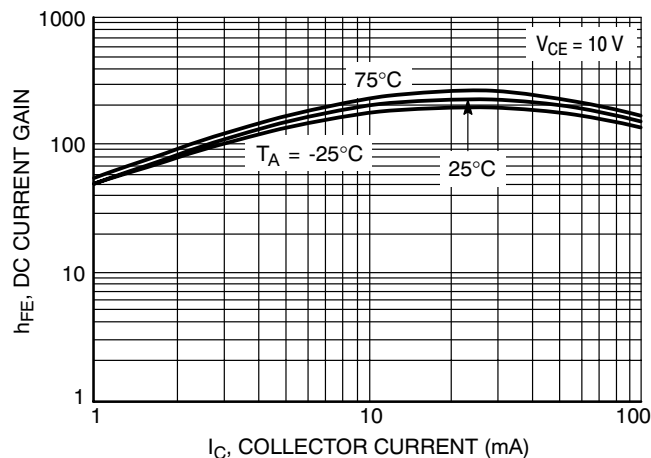

Figure 38. DC Current Gain

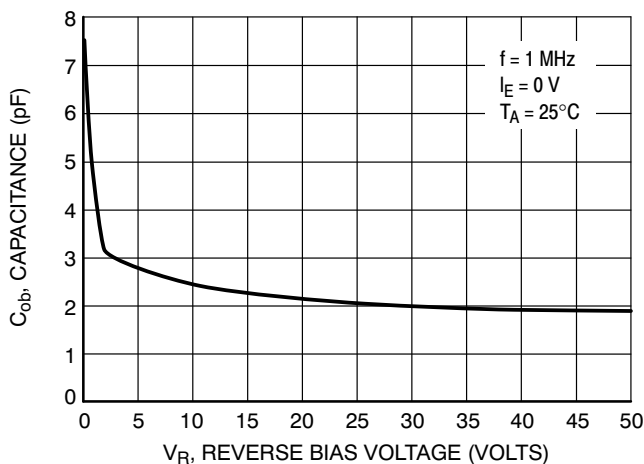

Figure 39. Output Capacitance

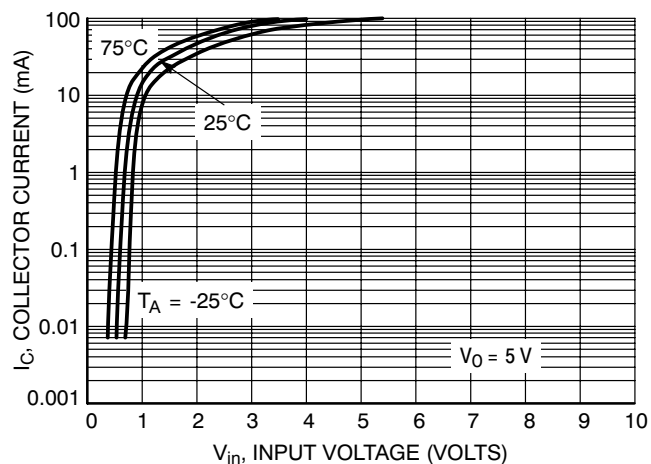

Figure 40. Output Current versus Input Voltage

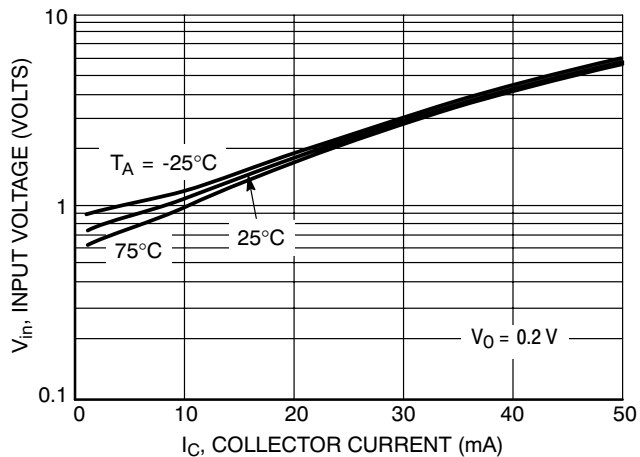

Figure 41. Input Voltage versus Output Current

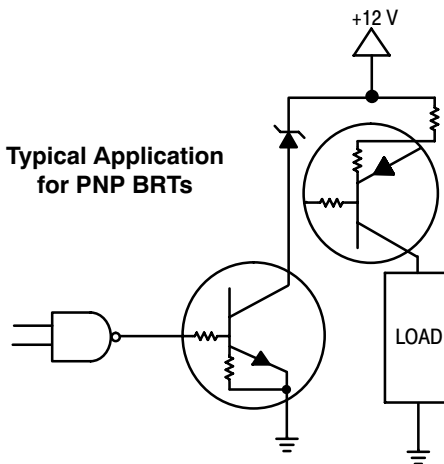
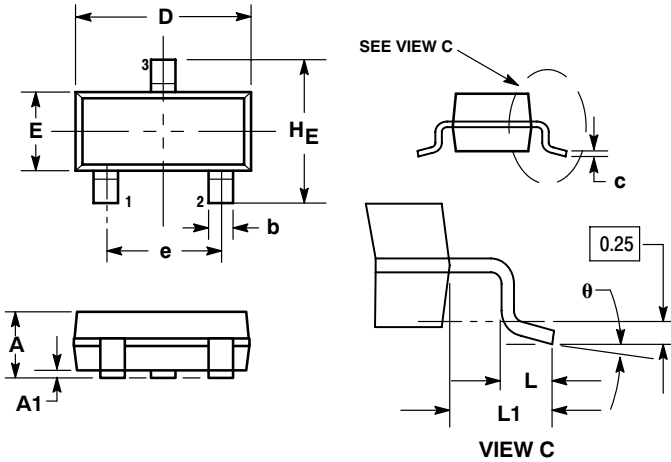

Figure 42. Inexpensive, Unregulated Current Source

MMUN2111LT1 Series

PACKAGE DIMENSIONS

SOT-23 (TO-236)
CASE 318-08
ISSUE AN



- NOTES:
1. DIMENSIONING AND TOLERANCING PER ANSI Y14.5M, 1982.
 2. CONTROLLING DIMENSION: INCH.
 3. MAXIMUM LEAD THICKNESS INCLUDES LEAD FINISH THICKNESS. MINIMUM LEAD THICKNESS IS THE MINIMUM THICKNESS OF BASE MATERIAL.
 4. 318-01 THRU -07 AND -09 OBSOLETE, NEW STANDARD 318-08.

DIM	MILLIMETERS			INCHES		
	MIN	NOM	MAX	MIN	NOM	MAX
A	0.89	1.00	1.11	0.035	0.040	0.044
A1	0.01	0.06	0.10	0.001	0.002	0.004
b	0.37	0.44	0.50	0.015	0.018	0.020
c	0.09	0.13	0.18	0.003	0.005	0.007
D	2.80	2.90	3.04	0.110	0.114	0.120
E	1.20	1.30	1.40	0.047	0.051	0.055
e	1.78	1.90	2.04	0.070	0.075	0.081
L	0.10	0.20	0.30	0.004	0.008	0.012
L1	0.35	0.54	0.69	0.014	0.021	0.029
HE	2.10	2.40	2.64	0.083	0.094	0.104

STYLE 6:
PIN 1. BASE
2. EMITTER
3. COLLECTOR

SOLDERING FOOTPRINT*

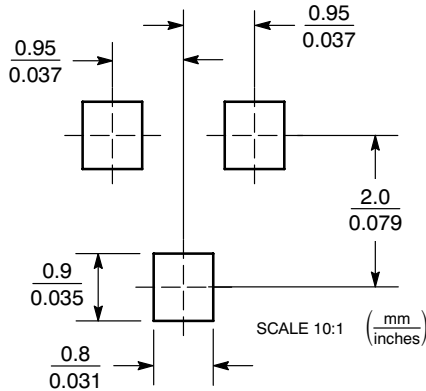

*For additional information on our Pb-Free strategy and soldering details, please download the ON Semiconductor Soldering and Mounting Techniques Reference Manual, SOLDERRM/D.

ON Semiconductor and are registered trademarks of Semiconductor Components Industries, LLC (SCILLC). SCILLC reserves the right to make changes without further notice to any products herein. SCILLC makes no warranty, representation or guarantee regarding the suitability of its products for any particular purpose, nor does SCILLC assume any liability arising out of the application or use of any product or circuit, and specifically disclaims any and all liability, including without limitation special, consequential or incidental damages. "Typical" parameters which may be provided in SCILLC data sheets and/or specifications can and do vary in different applications and actual performance may vary over time. All operating parameters, including "Typicals" must be validated for each customer application by customer's technical experts. SCILLC does not convey any license under its patent rights nor the rights of others. SCILLC products are not designed, intended, or authorized for use as components in systems intended for surgical implant into the body, or other applications intended to support or sustain life, or for any other application in which the failure of the SCILLC product could create a situation where personal injury or death may occur. Should Buyer purchase or use SCILLC products for any such unintended or unauthorized application, Buyer shall indemnify and hold SCILLC and its officers, employees, subsidiaries, affiliates, and distributors harmless against all claims, costs, damages, and expenses, and reasonable attorney fees arising out of, directly or indirectly, any claim of personal injury or death associated with such unintended or unauthorized use, even if such claim alleges that SCILLC was negligent regarding the design or manufacture of the part. SCILLC is an Equal Opportunity/Affirmative Action Employer. This literature is subject to all applicable copyright laws and is not for resale in any manner.

PUBLICATION ORDERING INFORMATION

LITERATURE FULFILLMENT:
Literature Distribution Center for ON Semiconductor
P.O. Box 5163, Denver, Colorado 80217 USA
Phone: 303-675-2175 or 800-344-3860 Toll Free USA/Canada
Fax: 303-675-2176 or 800-344-3867 Toll Free USA/Canada
Email: orderlit@onsemi.com

N. American Technical Support: 800-282-9855 Toll Free
USA/Canada
Europe, Middle East and Africa Technical Support:
Phone: 421 33 790 2910
Japan Customer Focus Center
Phone: 81-3-5773-3850

ON Semiconductor Website: www.onsemi.com
Order Literature: <http://www.onsemi.com/orderlit>
For additional information, please contact your local Sales Representative