



## 3-conductor diode terminal block; with diode 1N4007

Item No.: 2001-1311/1000-411



### Marking

RoHS ✓  
Compliant

### Business data

Supplier	WAGO
Item no.	2001-1311/1000-411
GTIN / EAN	4045454537579
Content	1

### Notes

### Technical data

#### Miscellaneous

Ratings per	IEC/EN 60947-7-1
Rated current [A]	0.5 [A]
Nominal voltage [V]	250 [V]
Reverse voltage [V]	1000 [V]
Type of wiring	Front-entry wiring

<b>Technical data</b>	
Total number of connection points	3
Total number of potentials	1
Number of levels	1
Connection technology	Push-in CAGE CLAMP®
Actuation type	Push-in
Connectable conductor materials	Copper
Nominal cross section	1.5 mm <sup>2</sup>
Solid conductor	0.25 ... 2.5 mm <sup>2</sup> / 22 ... 14 AWG
Solid conductor, push-in termination	0.5 ... 2.5 mm <sup>2</sup> / 20 ... 14 AWG
Fine-stranded conductor	0.25 ... 2.5 mm <sup>2</sup> / 22 ... 14 AWG
Fine-stranded conductor with ferrule, push-in termination, f	0.75 mm <sup>2</sup> / 18 AWG
Strip length	9 ... 11 mm / 0.35 ... 0.43 Inch
Width	4.2 mm / 0.165 Inch
Height from upper-edge of DIN-35 rail	32.9 mm / 1.295 Inch
Depth	59.2 mm / 2.33 Inch
Design	horizontal
Type of mounting	Carrier rail 35 x 15
Marking level	Center/side marking
Color	gray
Insulating material	Polyamide 66 (PA 66)
Fire load [MJ]	0.108 [MJ]
Weight [g]	5.014 [g]
Product Family	TOPJOB® S
Main product function	Diode terminal block
Product type	Function modules

Images & drawings

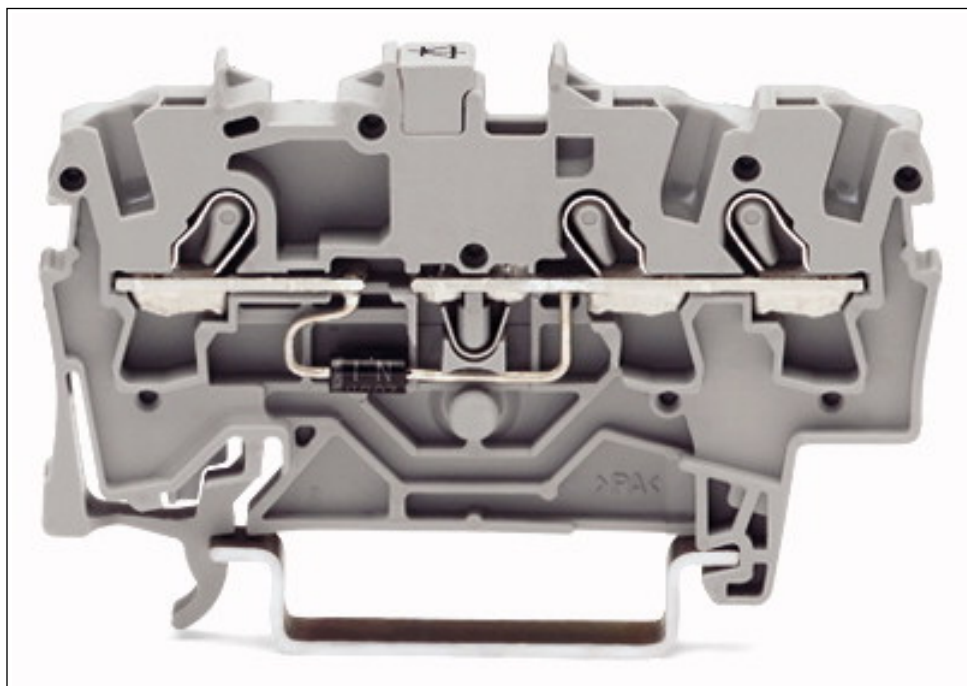
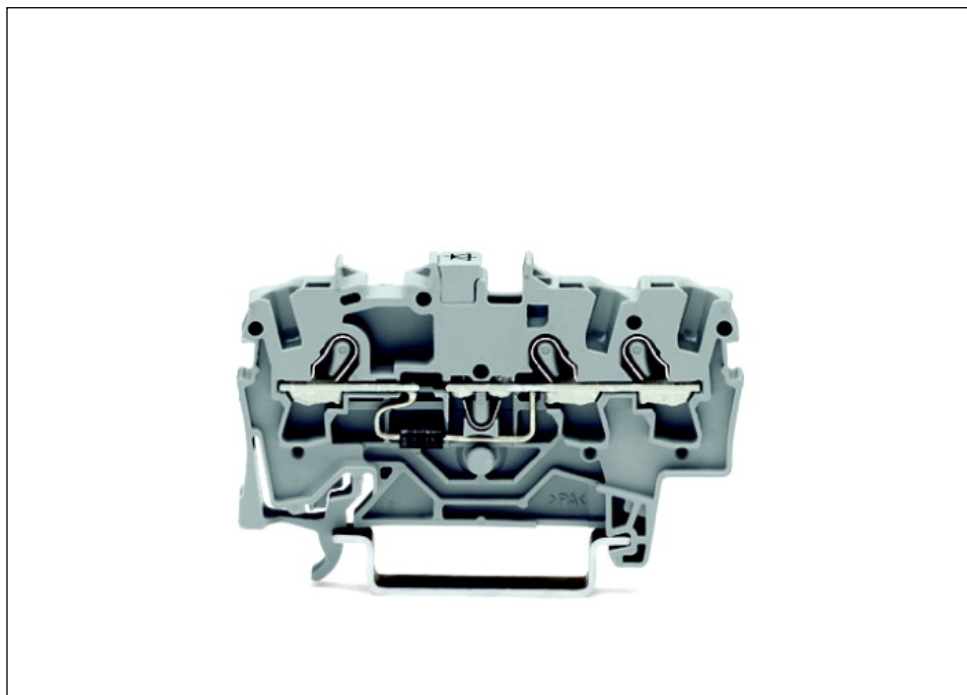

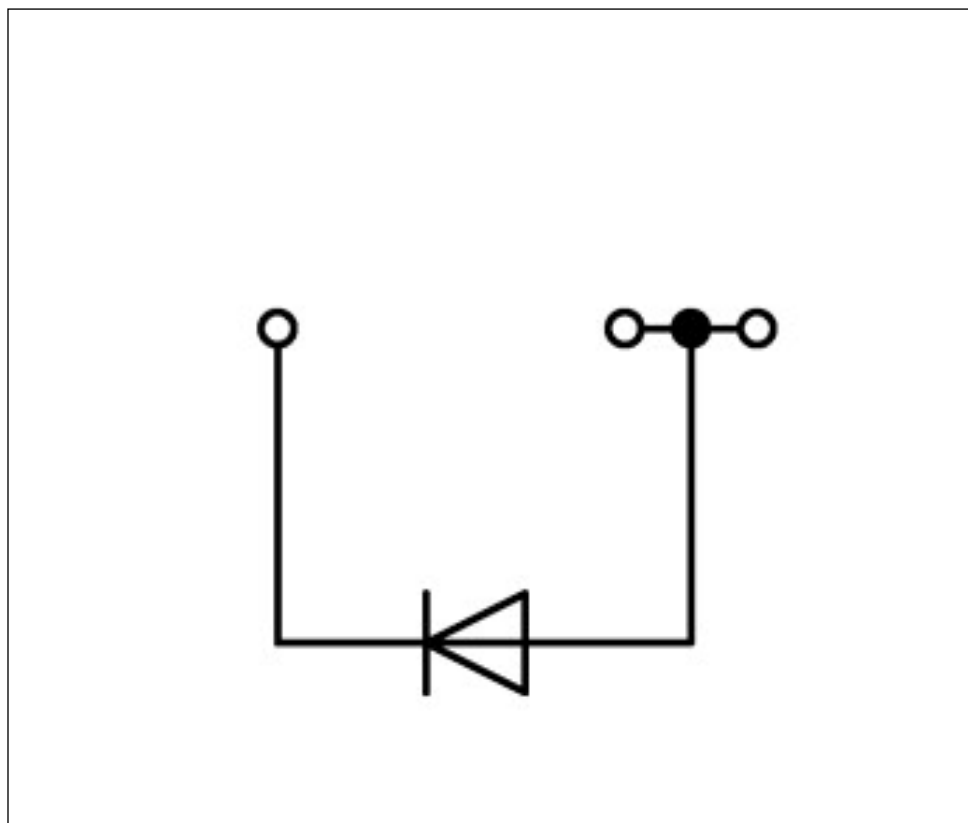
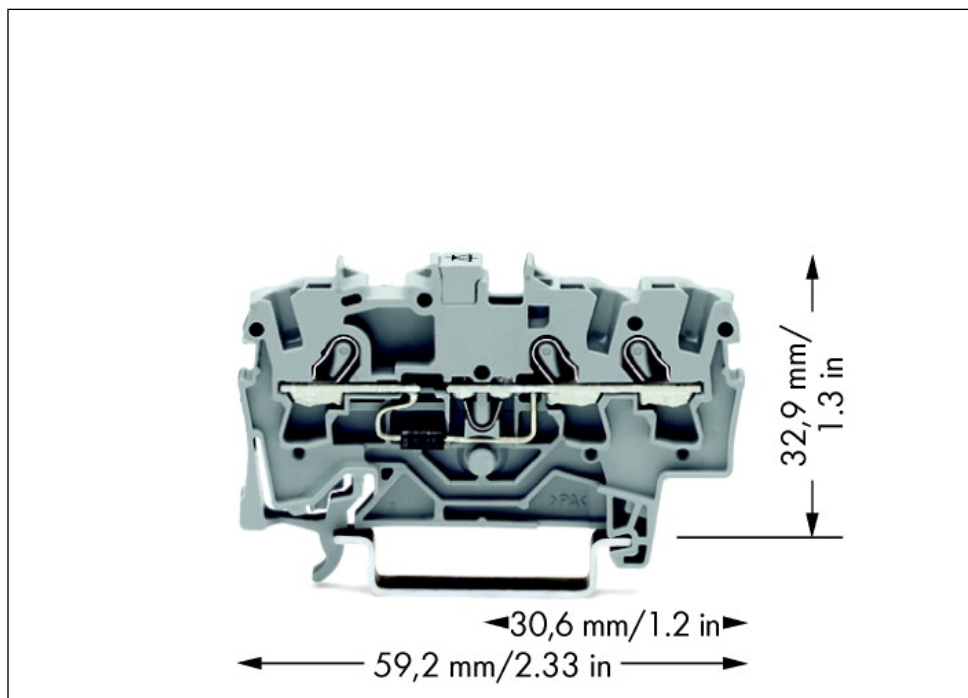

**Address**

WAGO Kontakttechnik GmbH & Co. KG

Hansastr. 27

32423 Minden

Telefon: 0571/887-0

Fax: 0571/887-169

<http://www.wago.com>

© WAGO Kontakttechnik GmbH & Co. KG

Technische Änderungen und Irrtümer vorbehalten.