

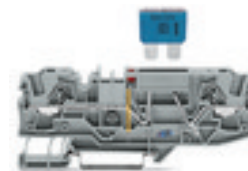

2-conductor fuse terminal block for mini-automotive blade-style fuses; with test option; 24 V; with blown fuse indication by LED; Power consumption LED: 4.8 mA

Item No.: 2006-1681/1000-434



2-conductor fuse terminal block for mini-automotive blade-style fuses; with test option; 24 V; with blown fuse indication by LED; Power consumption LED: 4.8 mA

Marking

RoHS ✓
Compliant

Business data

Supplier	WAGO
Item no.	2006-1681/1000-434
GTIN / EAN	4045454789800
Content	1

Notes

Safety information 1: Electrical ratings are given by the fuse and blown fuse indication. Safety information 2: Blade-style fuses, please note touchproof protection for 42V and higher.

Technical data

Miscellaneous

Ratings per	IEC/EN 60947-7-3
Rated voltage (III / 3) [V]	500 [V]
Rated impulse voltage (III / 3) [kV]	8 [kV]

Technical data	
<i>Rated current [A]</i>	<i>25 [A]</i>
<i>Rated current (2) [A]</i>	<i>30 [A]</i>
<i>Legend (ratings)</i>	<i>(III / 3) Overvoltage category III / Pollution degree 3</i>
<i>Connection technology</i>	<i>Push-in CAGE CLAMP®</i>
<i>Actuation type</i>	<i>Push-in</i>
<i>Connectable conductor materials</i>	<i>Copper</i>
<i>Nominal cross section</i>	<i>6 mm²</i>
<i>Solid conductor</i>	<i>0.5 ... 10 mm² / 20 ... 8 AWG</i>
<i>Solid conductor, push-in termination</i>	<i>1 ... 10 mm² / 14 ... 8 AWG</i>
<i>Fine-stranded conductor</i>	<i>0.5 ... 10 mm² / 20 ... 8 AWG</i>
<i>Fine-stranded conductor with ferrule, push-in termination, f</i>	<i>1.5 mm² / 16 AWG</i>
<i>Strip length</i>	<i>13 ... 15 mm / 0.51 ... 0.59 Inch</i>
<i>Total number of connection points</i>	<i>2</i>
<i>Total number of potentials</i>	<i>2</i>
<i>Number of levels</i>	<i>1</i>
<i>Type of wiring</i>	<i>Front-entry wiring</i>
<i>Width</i>	<i>7.5 mm / 0.295 Inch</i>
<i>Height from upper-edge of DIN-35 rail</i>	<i>32.9 mm / 1.295 Inch</i>
<i>Depth</i>	<i>96.3 mm / 3.791 Inch</i>
<i>Design</i>	<i>horizontal</i>
<i>Type of mounting</i>	<i>Carrier rail 35 x 15</i>
<i>Marking level</i>	<i>Center/side marking</i>
<i>Color</i>	<i>gray</i>
<i>Insulating material</i>	<i>Polyamide 66 (PA 66)</i>
<i>Weight [g]</i>	<i>17.7 [g]</i>
<i>Packaging type</i>	<i>BOX</i>
<i>Product Family</i>	<i>TOPJOB® S</i>
<i>Main product function</i>	<i>Fuse term. block</i>
<i>Product type</i>	<i>Function modules</i>

Images & drawings

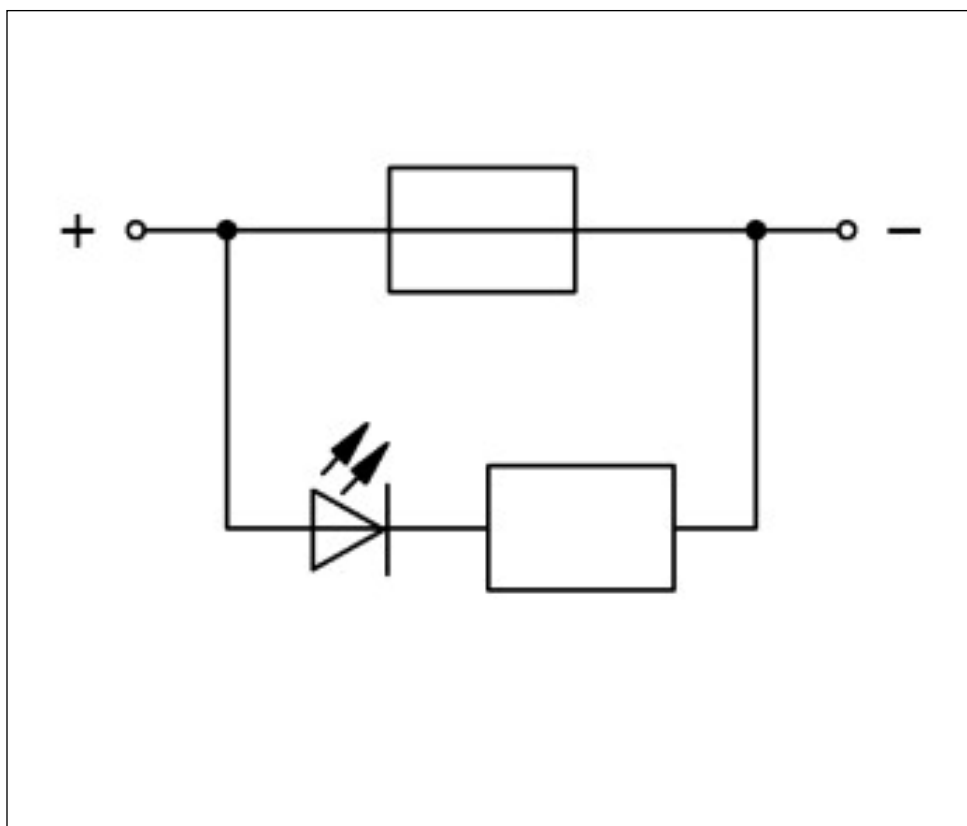
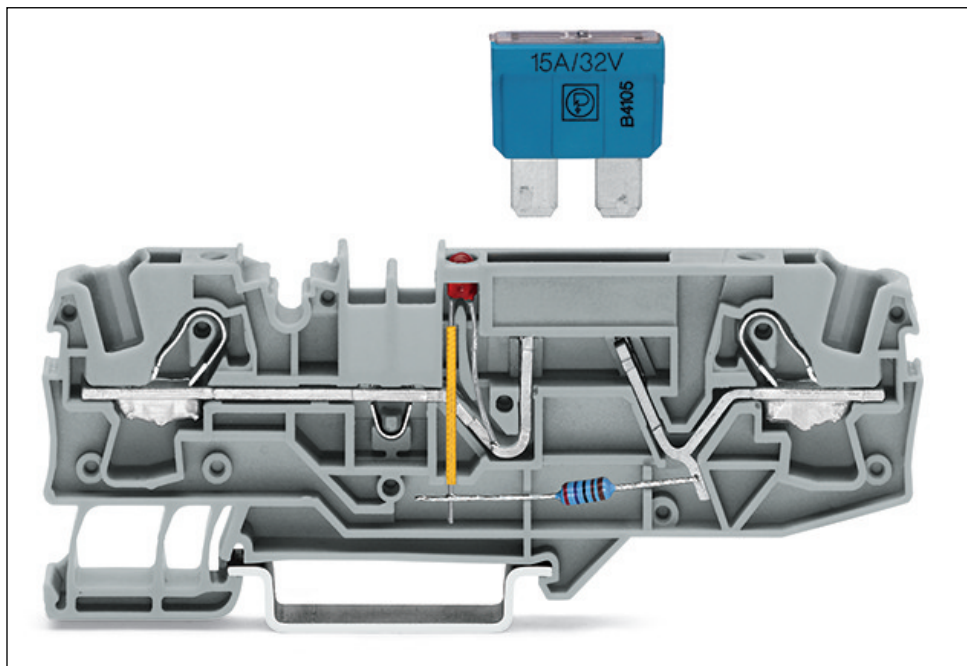

Address

WAGO Kontakttechnik GmbH & Co. KG

Hansastr. 27

32423 Minden

Telefon: 0571/887-0

Fax: 0571/887-169

<http://www.wago.com>

© WAGO Kontakttechnik GmbH & Co. KG

Technische Änderungen und Irrtümer vorbehalten.