

7300 series ABS cases

Product overview

Robust IP65 ABS cases to protect electrical and electronic components in rugged environments.

- Moulded in high quality ABS
- PCB pillars in base with threaded inserts and for self-tapping screws
- Lid mounted by four M3 machine screws
- Neoprene gasket included
- Clear lid option
- 7300 series has been designed to meet the requirements of IP65

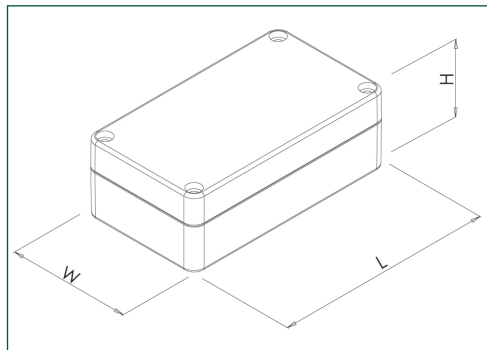

SPECIFICATION	
Materials	Base and lid high grade ABS
Operating temperature	-40°C to +80°C
Protection class	7300 series has been designed to meet the requirements of IP65
Standard colours	Dark grey, similar to RAL 7000
Standard unit includes	Box and lid 4x M4 non-magnetic machine screws Neoprene gasket

GREY LID	CLEAR LID	LENGTH	WIDTH	HEIGHT
7300-362	7300-362C	52mm	50mm	35mm
7300-302	7300-302C	64mm	58mm	35mm
7300-366	7300-366C	82mm	80mm	55mm
7300-304	7300-304C	115mm	65mm	40mm
7300-308	7300-308C	115mm	65mm	55mm
7300-311	7300-311C	115mm	90mm	55mm
7300-331	7300-331C	115mm	90mm	80mm
7300-386	7300-386C	120mm	120mm	60mm
7300-387	7300-387C	120mm	120mm	90mm
7300-368	7300-368C	160mm	80mm	55mm
7300-369	7300-369C	160mm	80mm	85mm
7300-396	7300-396C	160mm	160mm	60mm
7300-399	7300-399C	160mm	160mm	90mm
7300-313	7300-313C	171mm	121mm	55mm
7300-340	7300-340C	171mm	121mm	80mm
7300-346	7300-346C	195mm	80mm	55mm
7300-373	7300-373C	200mm	120mm	75mm
7300-317	7300-317C	222mm	146mm	55mm
7300-353	7300-353C	222mm	146mm	75mm
7300-3008	7300-3008C	240mm	160mm	90mm
7300-3019	7300-3019C	240mm	160mm	120mm
7300-378	7300-378C	265mm	185mm	95mm
7300-3028	7300-3028C	300mm	230mm	86mm
7300-3031	7300-3031C	300mm	230mm	111mm
7300-3039	7300-3039C	360mm	200mm	150mm

KEY FEATURES

High quality ABS | Clear lid option | PCB pillars | IP65

