



A range of miniature P.C.B. relays, with 1 or 2 CO (SPDT or DPDT) contacts

Features include:

- 1 CO (SPDT) contacts rated at 10 A or 16 A or 2 CO (DPDT) contacts rated at 8 A
- NO contact circuits available
- P.C.B. version
- AC, DC, DC sensitive or single bistable coil versions available
- Sealed version available. Sealed version has special removable pip to avoid ozone accumulation when relay is operating
- 8 mm, 6kV (1.2/50 μ s) between coil and contacts in accordance with VDE 0700
- Sockets and accessories: see 95 series
- Approvals (according to type): BBJ, BEAB, CSA, DEMKO, FIMKO, GOST, IMQ, NEMKO, RINA, SEMKO, SEV, cULus, UTE, VDE

AUTOMATIC
GATES

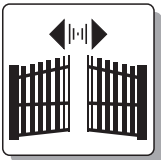

WHITE-GOODS



ALARM
SYSTEMS



INDUSTRIAL
AUTOMATION



BURNERS

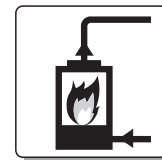

ELECTRONIC
APPLIANCES

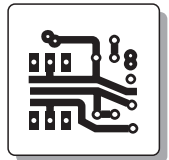

TIMERS



INDUSTRIAL
APPLIANCES



AIR
CONDITIONING

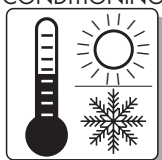

MEDICAL
EQUIPMENT





40.31



40.52



MINIATURE P.C.B. RELAYS 10 A

TYPE 40.31 1 CO (SPDT) 3.5 mm pinning

TYPE 40.51 1 CO (SPDT) 5 mm pinning

- Tin plated pins for P.C.B.

- Standard contact material: AgNi

Options:

TYPE 40.31-0300 1 NO (SPST-NO) 3.5 mm pinning

TYPE 40.51-0300 1 NO (SPST-NO) 5 mm pinning

- Options: see coding table page 17

- Ordering information: see page 17

MINIATURE P.C.B. RELAY 8 A

TYPE 40.52 2 CO (DPDT) 5 mm pinning

- Tin plated pins for P.C.B.

- Standard contact material: AgNi

Options:

TYPE 40.52-0300 2 NO (DPST-NO) 5 mm pinning

- Options: see coding table page 17

- Ordering information: see page 17

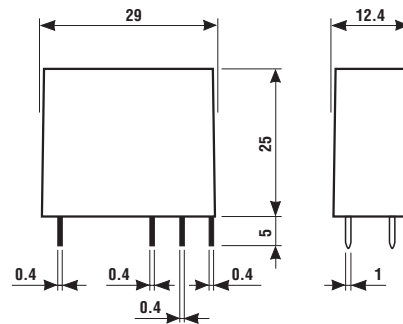
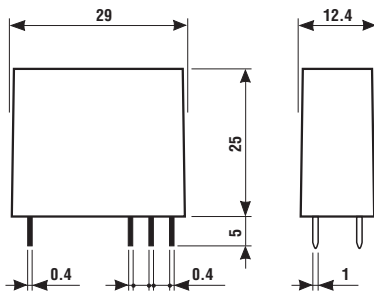

copper side view

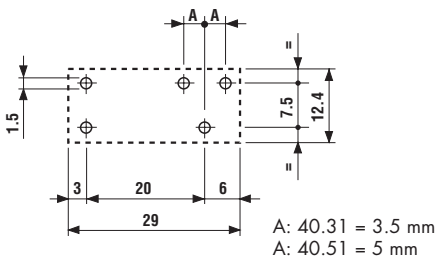

copper side view

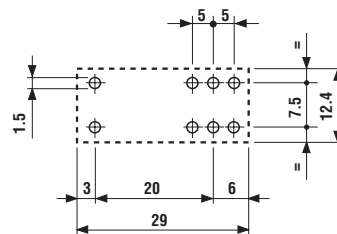



40.61



MINIATURE P.C.B. RELAY 16 A

TYPE 40.61 1 CO (SPDT) 5 mm pinning

- Tin plated pins for P.C.B.
- Standard contact material: AgCdO

Options:

TYPE 40.61-0300 1 NO (SPST-NO) 5 mm pinning

- Options: see coding table page 17
- Ordering information: see page 17

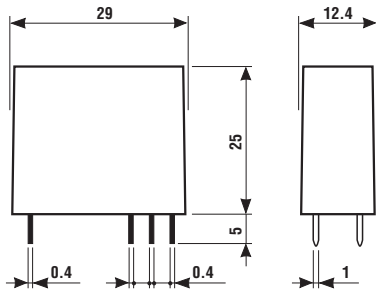

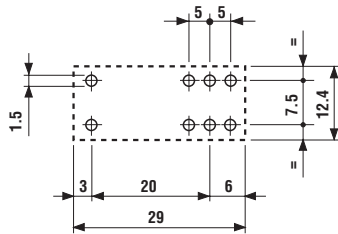

copper side view



<p>TYPE 40.31 (1 CO/SPDT)</p>	
<p>TYPE 40.31 (1 NO/SPST-NO)</p>	
<p>TYPE 40.51 (1 CO/SPDT)</p>	
<p>TYPE O 40.51 (1 NO/SPST-NO)</p>	
<p>TYPE 40.52 (2 CO/DPDT)</p>	
<p>TYPE 40.52 (2 NO/DPST-NO)</p>	
<p>TYPE 40.61 (1 CO/SPDT)</p>	
<p>TYPE 40.61 (1 NO/SPST-NO)</p>	

TECHNICAL DATA

ISOLATION according to EN 61810-5	rated impulse withstand voltage	3.6 kV
	degree of pollution	3 (1 CO) 2 (2 CO)
DIELECTRIC STRENGTH tested at leakage current ≤ 10 mA for 1 min at 50 Hz	between coil and contacts	4000 V
	between open contacts	1000 V
	between adjacent contacts	2000 V
	between frame and live parts	relay without external ground
SURGE TEST (1.2/50 μ s) BETWEEN COIL AND CONTACTS	6000 V	
ISOLATION RESISTANCE	$\geq 20 \cdot 10^3$ M Ω	
ISOLATION GROUP according to VDE 0110	C 250 (1 CO) B 250 (2 CO)	
ISOLATION DISTANCES	≥ 8 mm between coil and contacts according to VDE 0700 and EN 50178	
AMBIENT TEMPERATURE	1 CO: (-40...+70) $^{\circ}$ C 2 CO: (-40...+85) $^{\circ}$ C	
MAXIMUM SWITCHING FREQUENCY	- without load: 36000 cycles/h - at rated load: 1800 cycles/h (8 - 10 A) 600 cycles/h (16 A)	
MECHANICAL LIFE	- AC version: 10 $\cdot 10^6$ cycles - DC version: 20 $\cdot 10^6$ cycles	
PROTECTION CATEGORY OF ENCLOSURES	IP 40 IP 67 (sealed version option)	
OPERATE AND RELEASE TIME (AC and DC standard)	- pick-up time (from 0 to U_N): ≤ 10 ms (including contact bounce) - drop-out time (from U_N to 0): ≤ 10 ms (including contact bounce)	
OPERATE AND RELEASE TIME (DC sensitive)	- pick-up time (from 0 to U_N): ≤ 15 ms (including contact bounce) - drop-out time (from U_N to 0): ≤ 12 ms (including contact bounce)	
TYPE OF DUTY	continuous	
DIELECTRIC TEST	 1 CO  2 CO	
TYPE OF RELAY	all-or-nothing	
RECOMMENDED DISTANCE BETWEEN RELAYS MOUNTED ON P.C.Bs.	≥ 5 mm	

CONTACT SPECIFICATIONS

	40.31 - 40.51	40.52	40.61
RATED CURRENT	10 A	8 A	16 A
MAXIMUM PEAK CURRENT	20 A	15 A	30 A
NOMINAL RATE IN AC1	2,500 V A	2,000 V A	4,000 V A
NOMINAL RATE IN AC15 (230 V)	500 V A	400 V A	750 V A
RATED VOLTAGE	250 V AC	250 V AC	250 V AC
MAXIMUM SWITCHING VOLTAGE	400 V AC	400 V AC	400 V AC
BREAKING CAPACITY IN DC1	see diagram H 40	see diagram H 40	see diagram H 40
SINGLE PHASE MOTOR RATING (230 V AC)	0.37 kW/0.6 HP	0.3 kW/0.4 HP	0.55 kW/0.8 HP
CONTACT RESISTANCE: - initial	≤ 50 mΩ	≤ 50 mΩ	≤ 50 mΩ
MINIMUM SWITCHING LOAD	300 mW (5 V/5 mA)	300 mW (5 V/5 mA)	300 mW (10 V/5 mA)
STANDARD CONTACT MATERIAL	AgNi	AgNi	AgCdO

F 40/1

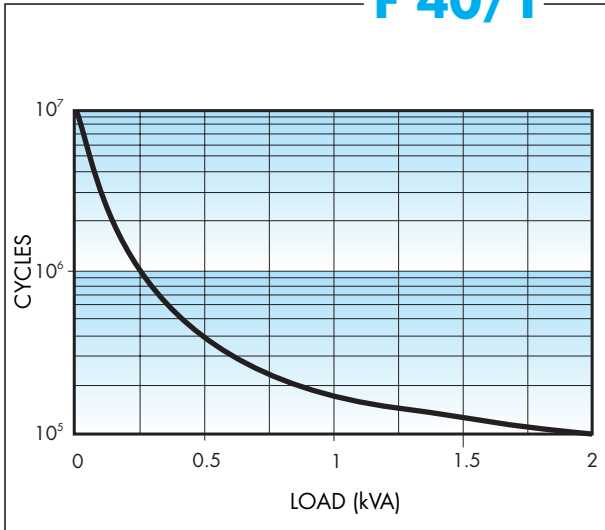

Contact life vs AC1 load.
Type 40.52 (8 A) at 1,800 cycles/h.

F 40/2

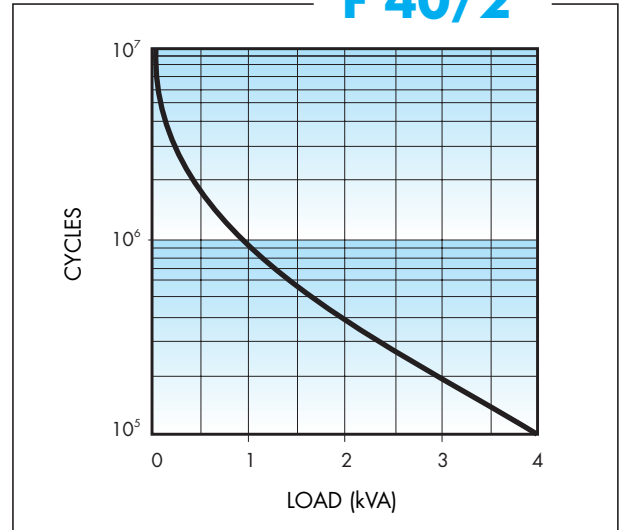

Contact life vs AC1 load.
Type 40.31 - 40.51 (10 A) at 1,800 cycles/h.
Type 40.61 (16 A) at 600 cycles/h.

H 40

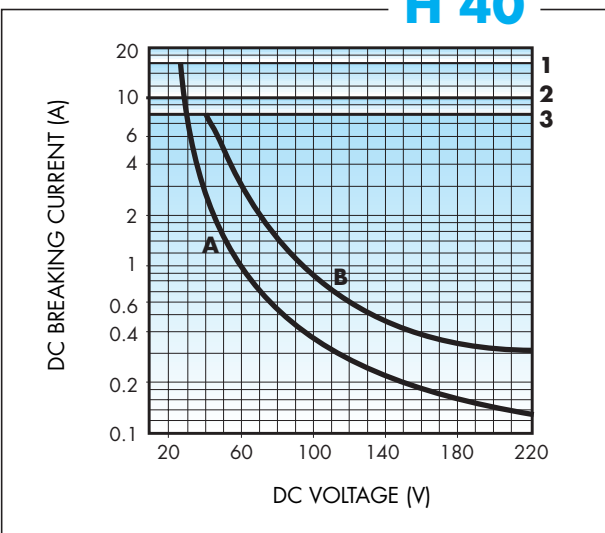

Breaking capacity for DC1 load.
1 - type 40.61 at 600 cycles/h
2 - type 40.31 - 40.51 at 1,800 cycles/h
3 - type 40.52 at 1,800 cycles/h
A - load applied to 1 contact
B - load applied to 2 contacts in series

K 40

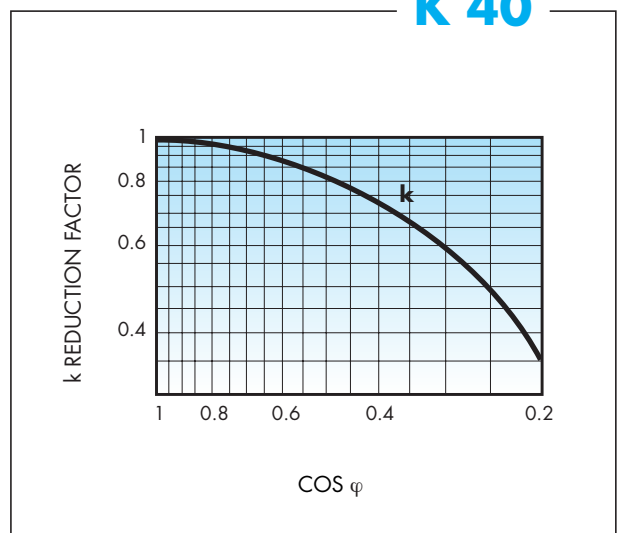

Load reduction factor vs cos ϕ .

COIL SPECIFICATIONS

VERSIONS:

AC - alternating current 50/60 Hz

DC - direct current

S sensitive - DC voltage with low absorption

	AC	DC	Sensitive DC
RATED POWER	1.2 VA	0.65 W	0.5 W
MINIMUM POWER	0.6 VA	0.35 W	0.25 W
OPERATING RANGE	class 1 (0.8...1.1)U _N	see diagram R 40/1	see diagram R 40/2
HOLDING VOLTAGE	0.8 U _N	0.4 U _N	0.4 U _N
MUST DROP-OUT VOLTAGE	0.2 U _N	0.1 U _N	0.1 U _N
NOMINAL MAGNETOMOTIVE FORCE	200 A	180 A	150 A
THERMAL INSULATION CLASS OF WIRE	F (+155°C)	F (+155°C)	F (+155°C)
THERMAL RESISTANCE	68°C/W	68°C/W	68°C/W
CONDUCTED DISTURBANCE IMMUNITY	BURST (acc. to EN 61000 - 4 - 4) level 4 (4 kV) SURGE (acc. to EN 61000 - 4 - 5) level 3 (2 kV)		

DC VERSION DATA (0.65 W standard)

R values relate to +20°C. Tolerance of R and I values: ± 10%.

Nominal voltage U _N	Operating range		Resistance R	Nominal coil absorption I at U _N
	U _{min}	U _{max}		
V	V	V	Ω	mA
5	3.65	7.5	38	130
6	4.4	9	55	109
7	5.1	10.5	75	93
9	6.6	13.5	125	72
12	8.8	18	220	55
14	10.2	21	300	47
18	13.1	27	500	36
21	15.3	31.5	700	30
24	17.5	36	900	27
28	20.5	42	1,200	23
36	26.3	54	2,000	18
48	35	72	3,500	14
60	43.8	90	5,500	11
90	65.7	135	12,500	7.2
110	80.3	165	18,000	6.1

DC VERSION DATA (0.5 W sensitive)

R values relate to +20°C. Tolerance of R and I values: ± 10%.

Nominal voltage U _N	Operating range		Resistance R	Nominal coil absorption I at U _N
	U _{min} *	U _{max}		
V	V	V	Ω	mA
5	3.7	8.8	50	100
6	4.4	10.5	75	80
7	5.1	12.2	100	70
9	6.6	15.8	160	56
12	8.8	21	300	40
14	10.2	24.5	400	35
18	13.2	31.5	650	27.7
21	15.4	36.9	900	23.3
24	17.5	42	1,200	20
28	20.5	49	1,600	17.5
36	26.3	63	2,600	13.8
48	35	84	4,800	10
60	43.8	105	7,200	8.3
90	65.7	157	16,200	5.5
110	80.3	192	23,500	4.7

*U_{min} = 0.8 U_N for 40.61

AC VERSION DATA

R values relate to +20°C. Tolerance of R and I values: ± 10%.

Nominal voltage U _N	Operating range		Resistance R	Nominal coil absorption I at U _N 50 Hz
	U _{min}	U _{max}		
V	V	V	Ω	mA
6	4.8	6.6	21	168
12	9.6	13.2	80	90
24	19.2	26.4	320	45
48	38.4	52.8	1,350	21
60	48	66	2,100	16.8
110	88	121	6,900	9.4
120	96	132	9,000	8.4
230	184	253	28,000	4.5
240	192	264	31,500	4.1

COIL SPECIFICATIONS

R 40/1

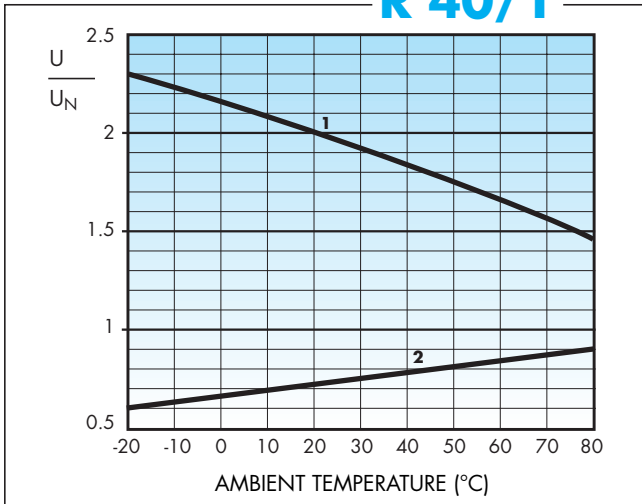

Operating range (DC type) vs ambient temperature.
1 - Max coil voltage permitted
2 - Min pick-up voltage with coil at ambient temperature

R 40/2

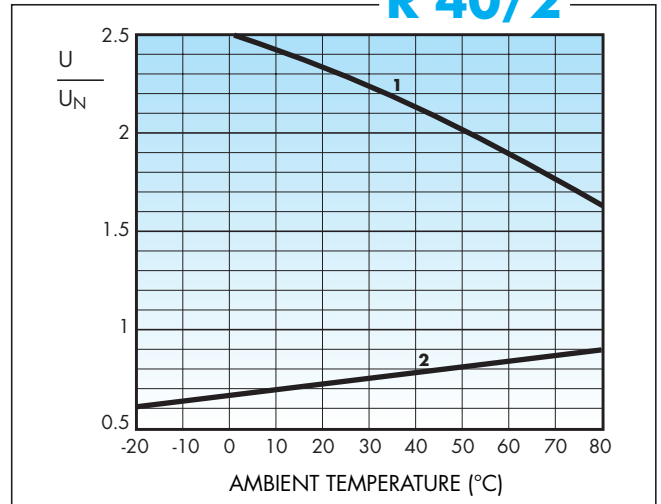

Operating range (DC sensitive type) vs ambient temperature.
1 - Max coil voltage permitted
2 - Min pick-up voltage with coil at ambient temperature

S 40/1

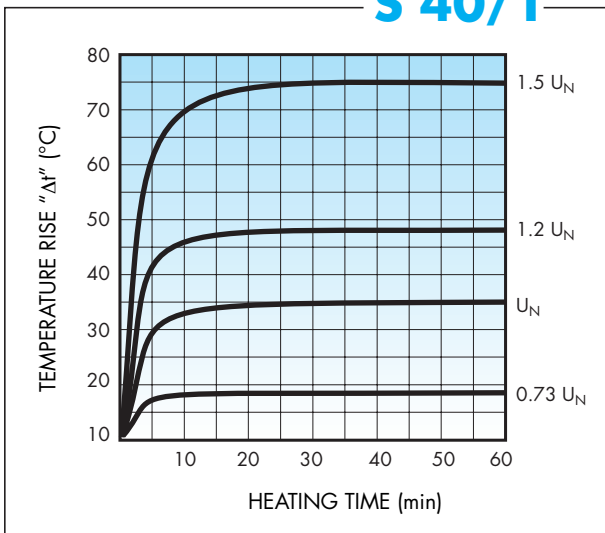

Temperature rise "Δt" vs applied voltage. DC coils.

S 40/2

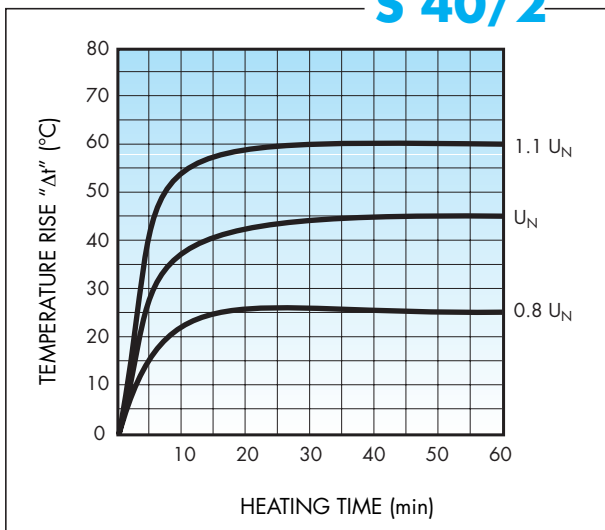

Temperature rise "Δt" vs applied voltage. AC 50 Hz coils.

S 40/3

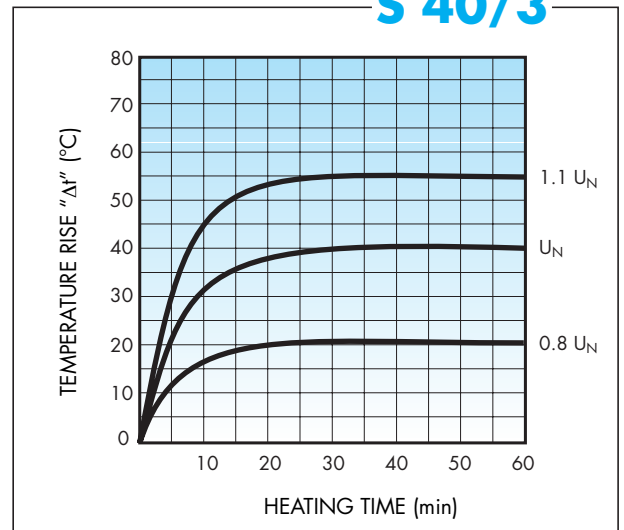

Temperature rise "Δt" vs applied voltage. AC 60 Hz coils.

BISTABLE COIL SPECIFICATIONS

RATED POWER	1.1 W
MINIMUM POWER	0.7 W
OPERATING RANGE	$(0.8 \dots 1.1)U_N$
NOMINAL MAGNETOMOTIVE FORCE	230 A
MINIMUM IMPULSE DURATION	20 ms
MAXIMUM IMPULSE DURATION	continuous
THERMAL INSULATION CLASS OF WIRE	F (+155°C)

DRIVING CIRCUIT (AC - DC)

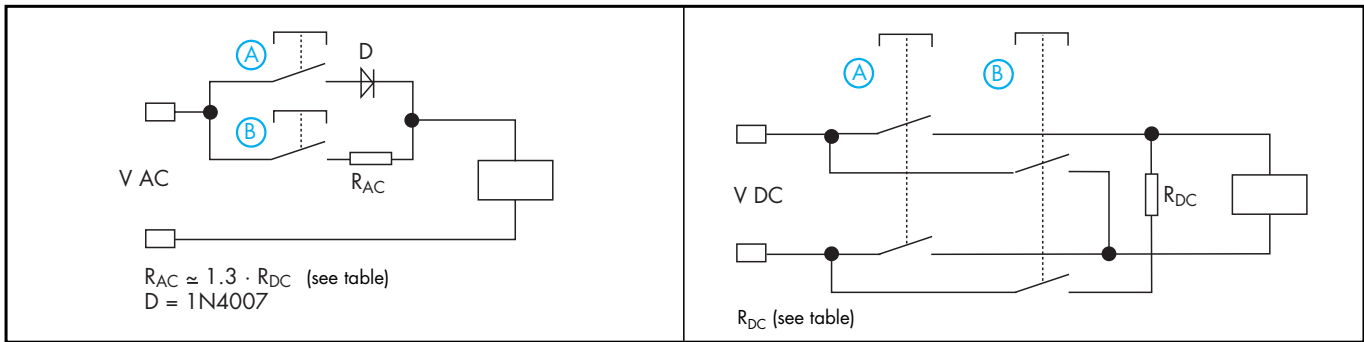

- (A) push once to pick-up
- (B) push once to drop-out

- (A) push once to pick-up
- (B) push once to drop-out

AC/DC VERSION DATA (bistable)

R values relate to +20°C. Tolerance of R and I values: $\pm 10\%$.

Nominal voltage U_N	Operating range		Resistance R	Nominal coil absorption I at U_N	DC: Release resistance** R_{DC}
	U_{min}	U_{max}			
V	V	V	Ω	mA	Ω
5	4	5.5	23	215	37
6	4.8	6.6	33	165	62
12	9.6	13.2	130	83	220
24	19.2	26.4	520	40	910
48	38.4	52.8	2,100	21	3,600
110	88	121	11,000	10	16,500

** R_{DC} = Resistance in DC, $R_{AC} = 1.3 \times R_{DC}$

ORDERING INFORMATION

Example: a 40 series P.C.B. relay with 2 CO (DPDT) contact, coil rated at 12 V AC.

4 0	5	2	8	0 1 2	0	0	0	0
Series	No. of poles		Coil version	Contact material and contact circuit	Special applications			
	1 = 1 CO (SPDT) for 40.31 40.51 40.61 2 = 2 CO (DPDT) for 40.52		6 = AC/DC bistable 7 = DC sensitive 8 = AC (50/60 Hz) 9 = DC	00 = Standard AgNi for 40.31, 51, 52 AgCdO for 40.61 03 = Contact NO 20 = AgCdO 40 = AgSnO ₂ 50 = AgNi + Au (5µm)**	00 = Standard 01 = Sealed version (IP67) * 03 = High temperature (+125°C) sealed version##			
	Type			Supply voltage				
	3 = 3.5 mm pinning 5 = 5 mm pinning 6 = 5 mm pinning			005 = 5 V DC only 006 = 6 V 007 = 7 V DC only 009 = 9 V DC only 012 = 12 V 014 = 14 V DC only 018 = 18 V DC only 021 = 21 V DC only 024 = 24 V	028 = 28 V DC only 036 = 36 V DC only 048 = 48 V 060 = 60 V 090 = 90 V DC only 110 = 110 V 120 = 120 V AC only 230 = 230 V AC only 240 = 240 V AC only			
* not available for bistable version								
** not available for 40.61								
## not available for sensitive DC and bistable versions								

Code	Coil type		Cover colour
9	DC	Direct current	transparent blue cover
8	AC	Alternating current at 50/60 Hz	transparent orange cover
7	S	Sensitive - DC with low consumption	transparent blue cover
6	BS	Bistable (single winding)	transparent green cover

OPTIONS



SEALED VERSION

Suitable for automated soldering and washing processes.



REMOVABLE VENTILATION PIP

Sealed version has special removable pip to avoid ozone accumulation when the relay is operating.

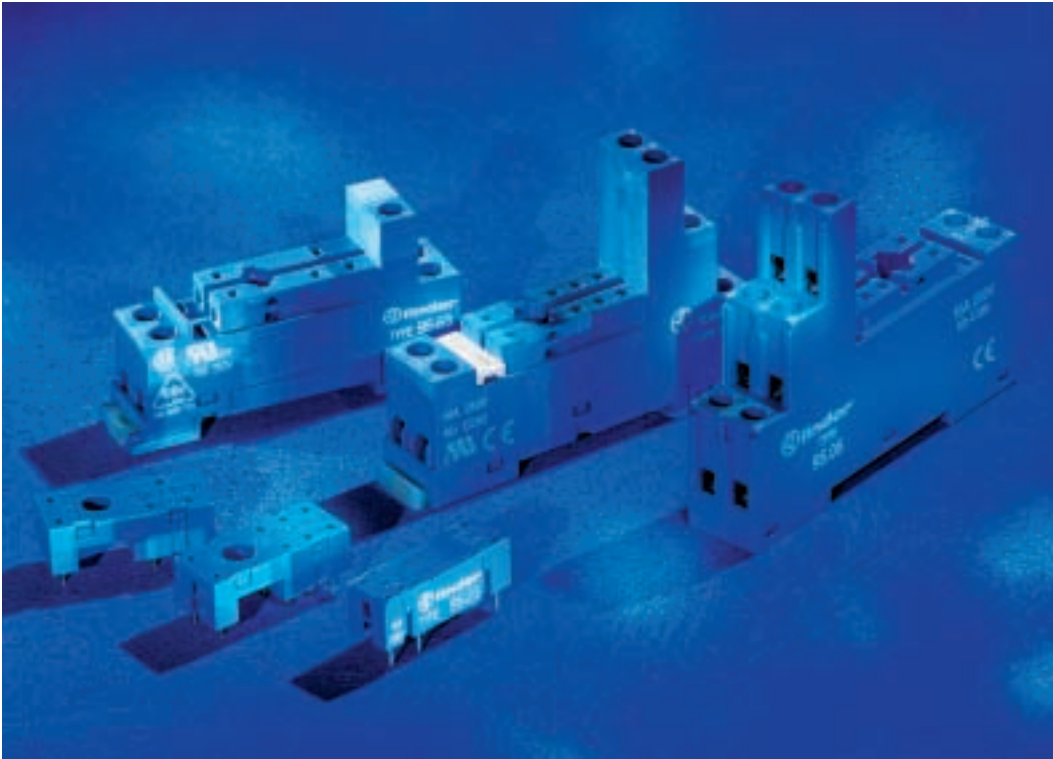

A range of sockets and accessories for 40 series relays

- P.C.B. version connections
- Flammability in accordance with UL 94
- Approvals (according to type): BBJ, CSA, CS - IMQ, SEV, cULus



95.15



P.C.B. SOCKETS

TYPE 95.13 for types 40.31

TYPE 95.15 for types 40.51 - 40.52 - 40.61

Accessories: **TYPE 095.51** metal retaining clip

TYPE 095.52 plastic retaining clip

CHARACTERISTICS

- LOAD: 10 A 250 V
- ISOLATION RESISTANCE: $\geq 10^3 \text{ M}\Omega$
- DIELECTRIC STRENGTH: $\geq 2 \text{ kV AC}$
- MATERIAL: self-extinguishing PPEm (V1)
- CONNECTIONS: Cu Sn 6 tin plated

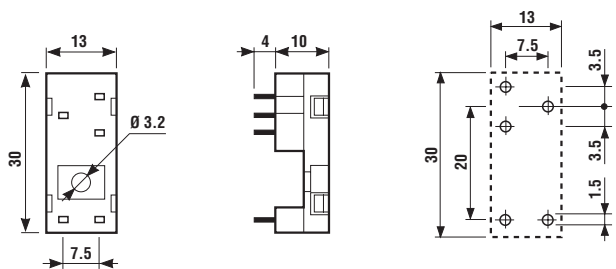

95.13

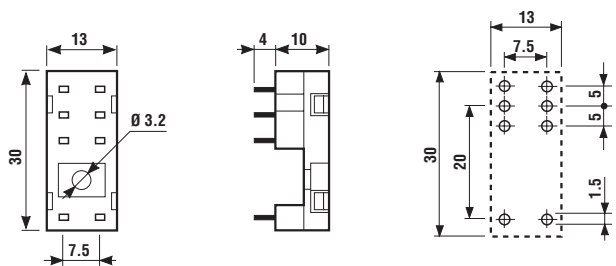

95.15

For interface modules using these relays, and for 35mm rail mount sockets, modules and accessories which can be used with these relays, please see the separate Industrial Relays and Sockets Technical Data section.