



2-conductor miniature through terminal block

Item No.: 264-711



2-conductor miniature through terminal block

Marking

RoHS
Compliant

Business data

Supplier	WAGO
Item no.	264-711
GTIN / EAN	4044918415415
Content	1

Notes

Technical data

Miscellaneous

Rated voltage (III / 3) [V]	800 [V]
Rated impulse voltage (III / 3) [kV]	8 [kV]
Rated current [A]	24 [A]
Legend (ratings)	(III / 3) Overvoltage category III / Pollution degree 3
Type of wiring	Front-entry wiring

Technical data	
<i>Total number of connection points</i>	2
<i>Total number of potentials</i>	1
<i>Number of levels</i>	1
<i>Connection technology</i>	CAGE CLAMP®
<i>Actuation type</i>	Operating tool
<i>Connectable conductor materials</i>	Copper
<i>Solid conductor</i>	0.08 ... 2.5 mm ² / 28 ... 12 AWG
<i>Fine-stranded conductor</i>	0.08 ... 2.5 mm ² / 28 ... 12 AWG
<i>Strip length</i>	8 ... 9 mm / 0.31 ... 0.35 Inch
<i>Note (conductor cross-section)</i>	12 AWG: THHN, THWN
<i>Width</i>	6 mm / 0.236 Inch
<i>Height from upper-edge of DIN-35 rail</i>	24.5 mm / 0.965 Inch
<i>Depth</i>	38 mm / 1.496 Inch
<i>Design</i>	horizontal
<i>Type of mounting</i>	Carrier rail 35 x 15
<i>Marking level</i>	Center marking
<i>Color</i>	gray
<i>Fire load [MJ]</i>	0.073 [MJ]
<i>Weight [g]</i>	3.878 [g]
<i>Main product function</i>	Through term. block
<i>Product type</i>	Miniature rail-mount terminal blocks

Images & drawings



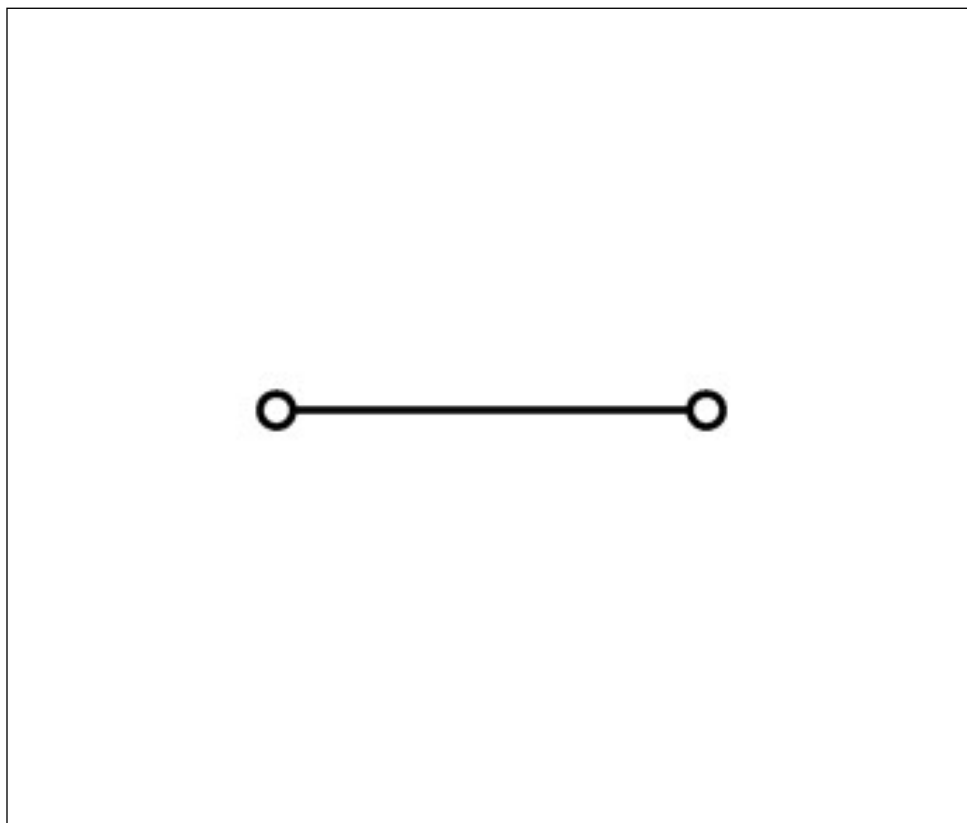
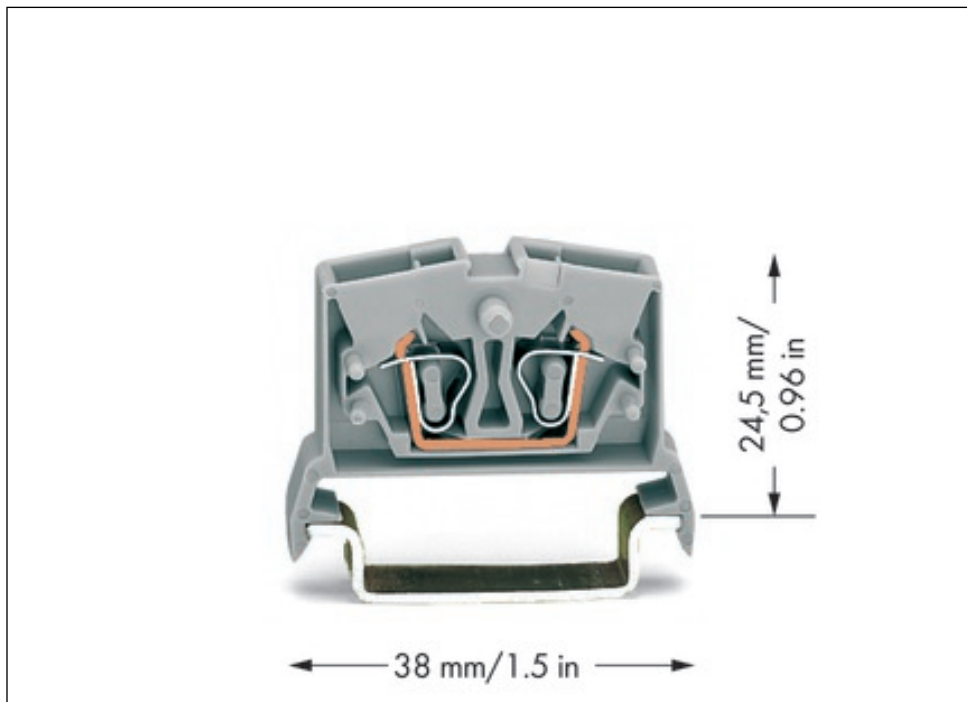

Address

WAGO Kontakttechnik GmbH & Co. KG

Hansastr. 27

32423 Minden

Telefon: 0571/887-0

Fax: 0571/887-169

<http://www.wago.com>

© WAGO Kontakttechnik GmbH & Co. KG

Technische Änderungen und Irrtümer vorbehalten.