

Data sheet | Item number: 264-701

2-conductor miniature through terminal block; 2.5 mm²; with test option;
center marking; for DIN-15 rail; CAGE CLAMP®

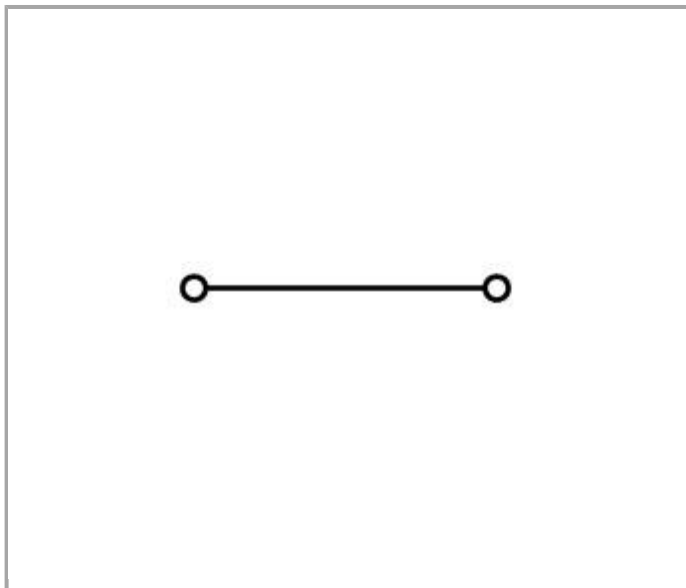

www.wago.com/264-701

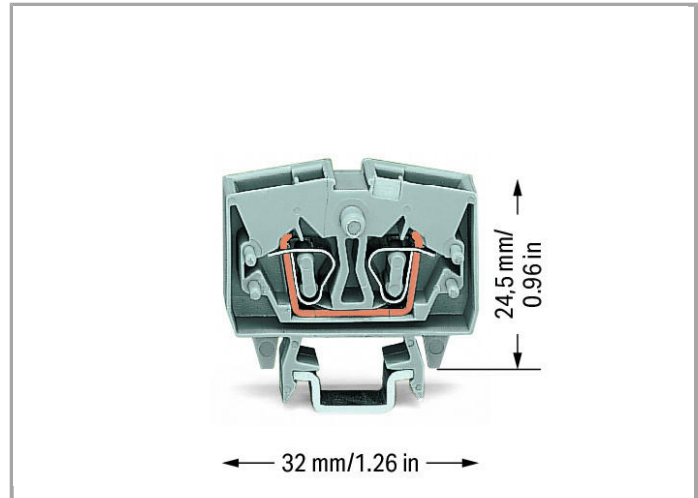
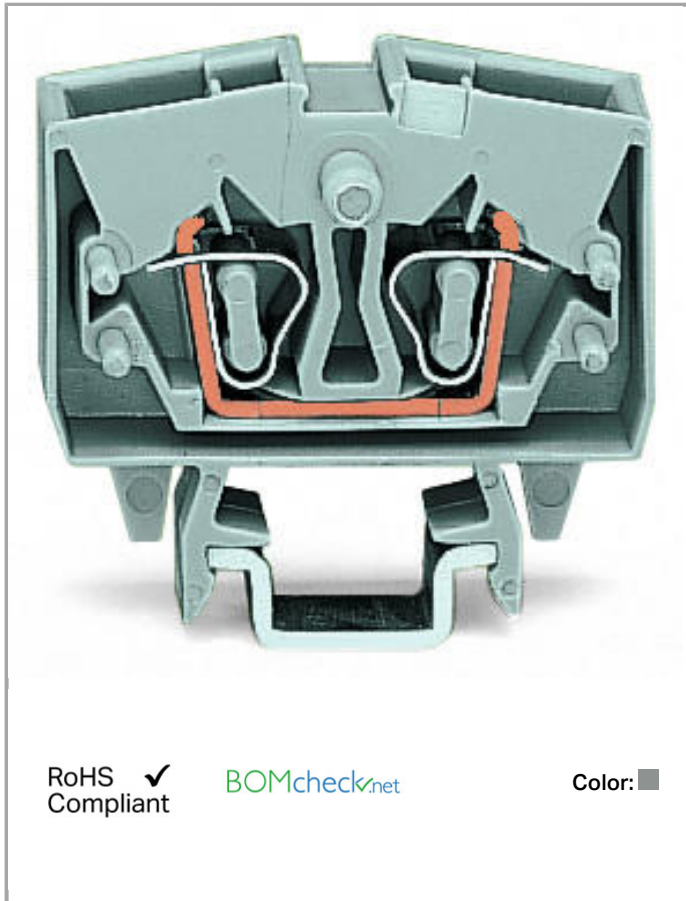

Data

Electrical data

Ratings per IEC/EN 60664-1

Rated voltage (III / 3)	800 V
Rated impulse voltage (III / 3)	8 kV
Rated current	24 A
Legend (ratings)	(III / 3) \triangleq Overvoltage category III / Pollution degree 3

Connection data

Connection technology	CAGE CLAMP®
Actuation type	Operating tool
Connectable conductor materials	Copper
Solid conductor	0.08 ... 2.5 mm ² / 28 ... 12 AWG
Fine-stranded conductor	0.08 ... 2.5 mm ² / 28 ... 12 AWG
Strip length	8 ... 9 mm / 0.31 ... 0.35 Inch
Total number of connection points	2
Total number of potentials	1
Number of levels	1
Type of wiring	Front-entry wiring

Geometrical Data

Width	6 mm / 0.236 inch
Height from upper-edge of DIN-35 rail	24.5 mm / 0.965 inch
Depth	32 mm / 1.26 inch

Mechanical data

Design	horizontal
Type of mounting	DIN-15 rail
Marking level	Center marking

Material Data

Color	gray
Fire load	0.072 MJ
Weight	3.744 g

Approvals / Certificates

Country specific Approvals

Logo	Approval	Certificate name
------	----------	------------------



CCA
DEKRA Certification B.V.

NTR NL-7077



CSA
DEKRA Certification B.V.





70010891



ENEC
DEKRA Certification B.V.

2160584.02

Ship Approvals

Logo	Approval	Certificate name
	ABS American Bureau of Shipping	14-HG1241539-PDA
	BV Bureau Veritas S.A.	07436/E0 BV
	DNV GL Det Norske Veritas, Germanischer Lloyd	TAE00001V2
	LR Lloyds Register	91/20242 (E7)

UL-Approvals

Logo	Approval	Certificate name
	UR Underwriters Laboratories Inc.	E45172, sec. 6

Subject to changes.