

Features

- ◆ Compact metal case with screw terminal block
- ◆ Dual and triple output models with isolated outputs
- ◆ Universal input 85–264 VAC
- ◆ EMI/EMC compliance with EN 61000-6-3 and EN 61000-6-1
- ◆ Compliance to EN 61000-3-2 (PFC)
- ◆ Short circuit and overvoltage protection
- ◆ International safety approvals
- ◆ 3-year product warranty

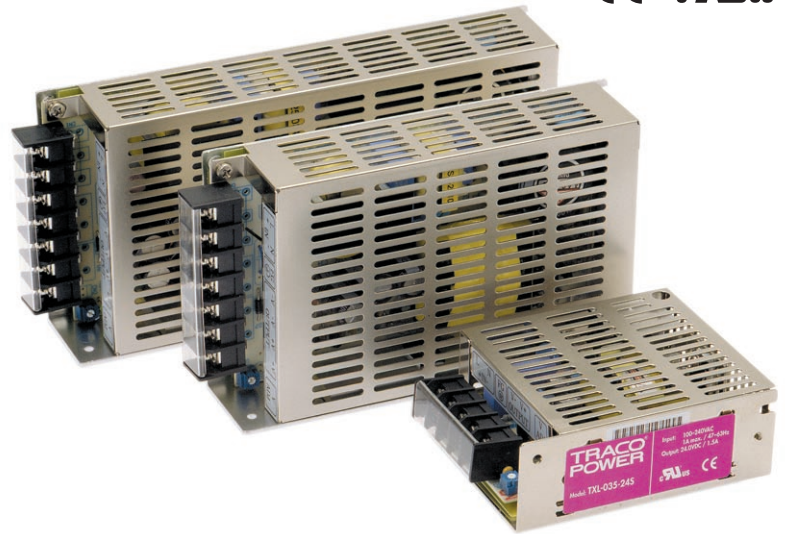

The TRACOPOWER TXL series is a family of enclosed power supplies designed for a wide range of cost critical applications. With a low profile metal case and screw terminal block connection, they are easy to install in any equipment.

There are 59 models in this range with single, dual, and triple output voltages from 3.3 VDC to 48 VDC in 10 power ranges from 25 W to 1000 W. These power supplies have universal input and comply with European EMC standards and the Low Voltage Directive (LVD).

Models with Single Output

Order Code	Case Type	Output Power max.	Output Voltage nom.	Output Current max.
TXL 015-3.3S TXL 015-05S TXL 015-12S TXL 015-15S TXL 015-24S TXL 015-48S	B	15 Watt	3.3 VDC 5 VDC 12 VDC 15 VDC 24 VDC 48 VDC	3.0 A 3.0 A 1.3 A 1.0 A 0.63 A 0.32 A
TXL 025-3.3S TXL 025-05S TXL 025-12S TXL 025-15S TXL 025-24S TXL 025-48S	C	25 Watt	3.3 VDC 5 VDC 12 VDC 15 VDC 24 VDC 48 VDC	6.0 A 5.0 A 2.1 A 1.7 A 1.1 A 0.57 A
TXL 035-3.3S TXL 035-05S TXL 035-12S TXL 035-15S TXL 035-24S TXL 035-48S	D	35 Watt	3.3 VDC 5 VDC 12 VDC 15 VDC 24 VDC 48 VDC	9.0 A 7.0 A 3.0 A 2.4 A 1.5 A 0.75 A
TXL 050-05S TXL 060-12S TXL 060-15S TXL 060-24S		50 / 60 Watt	5 VDC 12 VDC 15 VDC 24 VDC	10.0 A 5.0 A 4.0 A 2.5 A

Models with Single Output

Order Code	Case Type	Output Power max.	Output Voltage nom.	Output Current max.
TXL 060-3.3S TXL 060-05S TXL 070-12S TXL 070-15S TXL 070-24S TXL 070-48S	E	60 / 70 Watt	3.3 VDC 5 VDC 12 VDC 15 VDC 24 VDC 48 VDC	15.0 A 12.0 A 6.0 A 4.8 A 3.0 A 1.5 A
TXL 100-3.3S TXL 100-05S TXL 100-12S TXL 100-15S TXL 100-24S TXL 100-48S	J	100 Watt	3.3 VDC 5 VDC 12 VDC 15 VDC 24 VDC 48 VDC	25.0 A 20.0 A 8.5 A 6.8 A 4.5 A 2.1 A
TXL 120-12S TXL 120-15S TXL 120-24S TXL 120-48S	K	120 Watt	12 VDC 15 VDC 24 VDC 48 VDC	10.0 A 8.0 A 5.0 A 2.5 A
TXL 150-05S TXL 150-12S TXL 150-24S TXL 150-48S	L	150 Watt	5 VDC 12 VDC 24 VDC 48 VDC	30.0 A 12.5 A 6.3 A 3.2 A
TXL 220-12S TXL 220-24S TXL 220-48S	N	220 Watt	12 VDC 24 VDC 48 VDC	18.4 A 9.2 A 4.6 A
TXL 300-24S TXL 300-48S	O	300 Watt	24 VDC 48 VDC	12.5 A 6.5 A
TXL 600-24S TXL 600-48S	P	600 Watt	24 VDC 48 VDC	25.0 A 12.5 A
TXL 1000-24S TXL 1000-48S	Q	1000 Watt	24 VDC 48 VDC	40.0 A 20.0 A

Models with Multiple Output

Order Code	Case Type	Output Power max.	* Output1 (Main Output)	* Output 2	* Output 3
TXL 035-0512D TXL 035-0524D TXL 035-1212D TXL 035-1515D	D	35 Watt	+5 VDC/ 4.0 A +5 VDC/ 4.0 A +12 VDC/ 1.5 A +15 VDC/ 1.3 A	+12 VDC/ 1.5 A +24 VDC/ 1.3 A -12 VDC/ 1.5 A -15 VDC/ 1.3 A	
TXL 060-0512DI TXL 060-0524DI TXL 060-0521TI TXL 060-0522TI TXL 060-0533TI TXL 060-0534TI	E	60 Watt	5 VDC/ 8.0 A 5 VDC/ 6.0 A 5 VDC/ 8.0 A 5 VDC/ 7.0 A 5 VDC/ 7.0 A 5 VDC/ 6.0 A	12 VDC/ 4.0 A 24 VDC/ 2.2 A 12 VDC/ 3.5 A 12 VDC/ 3.5 A 15 VDC/ 3.0 A 12 VDC/ 1.5 A	5 VDC/ 1.0 A 12 VDC/ 1.0 A 15 VDC/ 1.0 A 24 VDC/ 1.2 A
TXL 100-0512DI TXL 100-0524DI TXL 100-0521TI TXL 100-0522TI TXL 100-0533TI TXL 100-0534TI	J	100 Watt	5 VDC/ 12.0 A 5 VDC/ 10.0 A 5 VDC/ 12.0 A 5 VDC/ 12.0 A 5 VDC/ 12.0 A 5 VDC/ 12.0 A	12 VDC/ 6.0 A 24 VDC/ 4.0 A 12 VDC/ 5.0 A 12 VDC/ 5.0 A 15 VDC/ 3.0 A 12 VDC/ 3.0 A	5 VDC/ 1.5 A 12 VDC/ 1.5 A 15 VDC/ 1.5 A 24 VDC/ 2.0 A

* Total power must not exceed specified max. output power

Input Specifications

Input voltage range	– nominal	100 – 240 VAC																																	
	– AC range (universal input)	85 – 264 VAC for 15 to 300 Watt model 85 – 264 VAC for 600 & 100 Watt models																																	
	– DC range	120 – 375 VDC or 15 to 300 Watt model 127 – 375 VDC for 600 & 100 Watt models																																	
Input current (at full load)		<table border="0"> <tr> <td></td> <td>V_{in} = 115 VAC</td> <td>V_{in} = 230 VAC</td> </tr> <tr> <td>TXL 015/025 models</td> <td>0.50 A typ.</td> <td>0.22 A typ.</td> </tr> <tr> <td>TXL 035 models</td> <td>0.70 A typ.</td> <td>0.42 A typ.</td> </tr> <tr> <td>TXL 060 / 070 models</td> <td>1.00 A typ.</td> <td>0.60 A typ.</td> </tr> <tr> <td>TXL 100 models</td> <td>1.65 A typ.</td> <td>0.95 A typ.</td> </tr> <tr> <td>TXL 120 models</td> <td>1.30 A typ.</td> <td>0.65 A typ.</td> </tr> <tr> <td>TXL 150 models</td> <td>2.10 A typ.</td> <td>1.10 A typ.</td> </tr> <tr> <td>TXL 220 models</td> <td>3.00 A typ.</td> <td>1.60 A typ.</td> </tr> <tr> <td>TXL 300 models</td> <td>3.30 A typ.</td> <td>1.70 A typ.</td> </tr> <tr> <td>TXL 600 models</td> <td>6.30 A typ.</td> <td>3.10 A typ.</td> </tr> <tr> <td>TXL 1000 models</td> <td>11.0 A typ.</td> <td>5.0 A typ.</td> </tr> </table>		V _{in} = 115 VAC	V _{in} = 230 VAC	TXL 015/025 models	0.50 A typ.	0.22 A typ.	TXL 035 models	0.70 A typ.	0.42 A typ.	TXL 060 / 070 models	1.00 A typ.	0.60 A typ.	TXL 100 models	1.65 A typ.	0.95 A typ.	TXL 120 models	1.30 A typ.	0.65 A typ.	TXL 150 models	2.10 A typ.	1.10 A typ.	TXL 220 models	3.00 A typ.	1.60 A typ.	TXL 300 models	3.30 A typ.	1.70 A typ.	TXL 600 models	6.30 A typ.	3.10 A typ.	TXL 1000 models	11.0 A typ.	5.0 A typ.
		V _{in} = 115 VAC	V _{in} = 230 VAC																																
	TXL 015/025 models	0.50 A typ.	0.22 A typ.																																
	TXL 035 models	0.70 A typ.	0.42 A typ.																																
	TXL 060 / 070 models	1.00 A typ.	0.60 A typ.																																
	TXL 100 models	1.65 A typ.	0.95 A typ.																																
	TXL 120 models	1.30 A typ.	0.65 A typ.																																
	TXL 150 models	2.10 A typ.	1.10 A typ.																																
	TXL 220 models	3.00 A typ.	1.60 A typ.																																
	TXL 300 models	3.30 A typ.	1.70 A typ.																																
	TXL 600 models	6.30 A typ.	3.10 A typ.																																
TXL 1000 models	11.0 A typ.	5.0 A typ.																																	
Input current (at no load)		<table border="0"> <tr> <td></td> <td>V_{in} = 115 VAC</td> <td>V_{in} = 230 VAC</td> </tr> <tr> <td>TXL 015/025 models</td> <td>10 mA typ.</td> <td>17 mA typ.</td> </tr> <tr> <td>TXL 035 models</td> <td>50 mA typ.</td> <td>55 mA typ.</td> </tr> <tr> <td>TXL 120 models</td> <td>135 mA typ.</td> <td>125 mA typ.</td> </tr> <tr> <td>TXL 220/300 models</td> <td>115 mA typ.</td> <td>140 mA typ.</td> </tr> <tr> <td>TXL 600 models</td> <td>210 mA typ.</td> <td>220 mA typ.</td> </tr> <tr> <td>TXL 1000 models</td> <td>330 mA typ.</td> <td>350 mA typ.</td> </tr> <tr> <td>other models</td> <td>100 mA typ.</td> <td>80 mA typ.</td> </tr> </table>		V _{in} = 115 VAC	V _{in} = 230 VAC	TXL 015/025 models	10 mA typ.	17 mA typ.	TXL 035 models	50 mA typ.	55 mA typ.	TXL 120 models	135 mA typ.	125 mA typ.	TXL 220/300 models	115 mA typ.	140 mA typ.	TXL 600 models	210 mA typ.	220 mA typ.	TXL 1000 models	330 mA typ.	350 mA typ.	other models	100 mA typ.	80 mA typ.									
		V _{in} = 115 VAC	V _{in} = 230 VAC																																
	TXL 015/025 models	10 mA typ.	17 mA typ.																																
	TXL 035 models	50 mA typ.	55 mA typ.																																
	TXL 120 models	135 mA typ.	125 mA typ.																																
	TXL 220/300 models	115 mA typ.	140 mA typ.																																
	TXL 600 models	210 mA typ.	220 mA typ.																																
TXL 1000 models	330 mA typ.	350 mA typ.																																	
other models	100 mA typ.	80 mA typ.																																	
Recommended circuit breaker (characteristic C) or slow blow fuse	up to 70Watt models:	5 A																																	
	up to 600 Watt models	10 A																																	
	TXL 1000 models	16 A																																	

Output Specifications

Output voltage adjustment range	±10 % – 35 Watt dual output models: range V _{out} 1-2 – other multi output models: V _{out} 1	
Regulation	– Input variation	1 % max.
	– Load variation (10–100%)	2 % max.
	single output models	4 % max. for main output
	multiple output models	6 % max. for output 2/3 (20–100 % load)
– Minimum load on main output of multiple output models (to provide the regulation on the auxiliary outputs)	0.3 A for TXL 035 1.0 A for TXL 060 1.5 A for TXL 100	
Ripple and noise (20 MHz bandwidth)	3.3VDC output	< 50mV
	Output 3 (on triple output models)	< 1.5% of V _{out}
	all other output voltages	< 1.0% of V _{out} nom.
Output current limitation	105 %–150 % of I _{out} max.	
Overload protection mode	Fold back, automatic recovery	
Over voltage protection (only output 1)	115 %–140 % of V _{out} nom. (depending on model)	
Capacitive load, max.	3.3 VDC–12 VDC output models	10'000 µF
	TXL 070: 24 VDC & 48VDC output models	10'000 µF
	TXL 100/150: 24 VDC & 48VDC output models	4'700 µF
	TXL 035/ 120: 24 VDC & 48VDC output models	1'000 µF
	TXL 025/ TXL 220: models	5'000 µF
	TXL 300 models	17'000 µF
	TXL 600 models	44'000 µF

General Specifications

Temperature ranges	<ul style="list-style-type: none"> – Operating – Load derating above 45°C – Storage (non operating) 	<p>–10°C to +70°C 2 %/°K (2.5 %/°K for TXL 120/220/1000) –10°C to +75°C</p>
Temperature coefficient		0.02 %/°C
Efficiency		70–84 % (depending on model)
Humidity (non condensing)		85 % rel max. (non condensing)
Switching frequency		50 kHz typ. (pulse width modulation)
Hold-up time		20 ms min.
Isolation voltage (60sec)	<ul style="list-style-type: none"> – Input/Output – Input/Case – Output/Case – Output/Output 	<p>3'000 VAC 1'500 VAC 500 VAC</p> <p>60-100 Watt multiple output models: 500 VAC (for all outputs of triple output models!) 35 Watt dual output models: outputs not isolated</p>
Reliability /calculated MTBF (MIL-HDBK-217F @ 25°C typ., ground benign)		>250'000 h
Electromagnetic compatibility (EMC), Emissions	<ul style="list-style-type: none"> – Conducted input RI suppression – Harmonic current emissions – Flicker 	<p>EN 55022, class B, FCC part 15, level B IEC/EN 61000-3-2, class D (TXL 120/150/220) IEC/EN 61000-3-2, class A (others) IEC/EN 61000-3-3</p>
Electromagnetic compatibility (EMC), Immunity	<ul style="list-style-type: none"> – Electrostatic discharge ESD – RF field immunity – Electrical fast transients/burst immunity – Surge – Conducted RF – Magnetic field – Voltage dip 	<p>IEC/EN 61000-4-2 4 kV / 8 kV IEC/EN 61000-4-3 3 V/m IEC/EN 61000-4-4 1 kV IEC/EN 61000-4-5 1 kV / 2 kV IEC/EN 61000-4-6 3 V/m IEC/EN 61000-4-8 3 A/m IEC/EN 61000-4-11</p>
Safety standards		UL 60950-1, IEC 60950-1, EN 60950-1
Safety approval		cUL/UL File E188913
Casing material	<p>TXL 025/035</p> <p>TXL 50/60/70/100</p> <p>others</p>	<p>nickel plated steel (chassis & cover)</p> <p>aluminium (chassis), nickel plated steel (cover)</p> <p>aluminium (chassis & cover)</p>

All specifications valid at nominal input voltage, full load and +25°C after warm-up time unless otherwise stated.

Case Dimensions

Case B

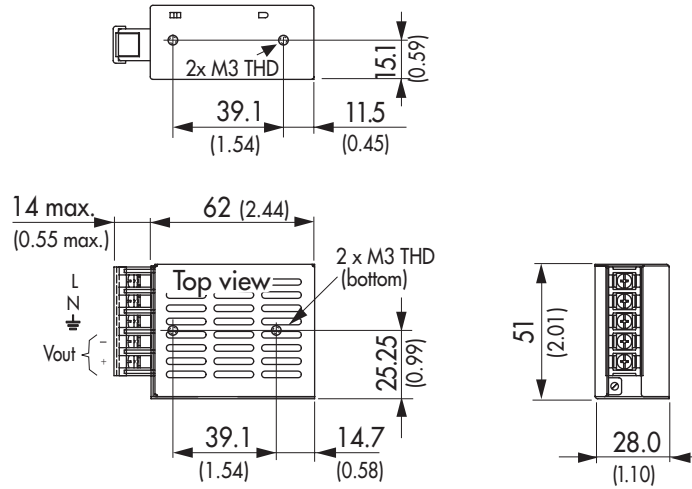

Weight: 0.13 kg (4.6 oz)

Case C

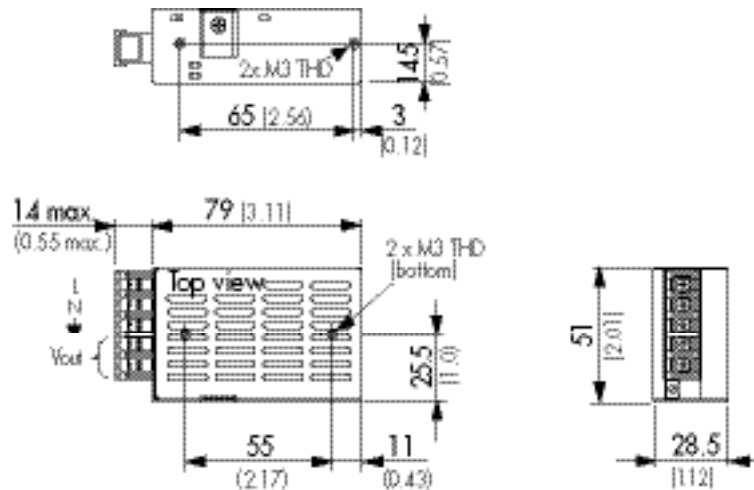

Weight: 0.19 kg (6.7 oz)

Case D

Connection		
	single	dual
1	AC L	AC L
2	AC N	AC N
3	AC FG	AC FG
4	-Vout	Common
5	+Vout	Vout 1
6	No con.	Vout 2

Weight: 0.3 kg (10 oz)

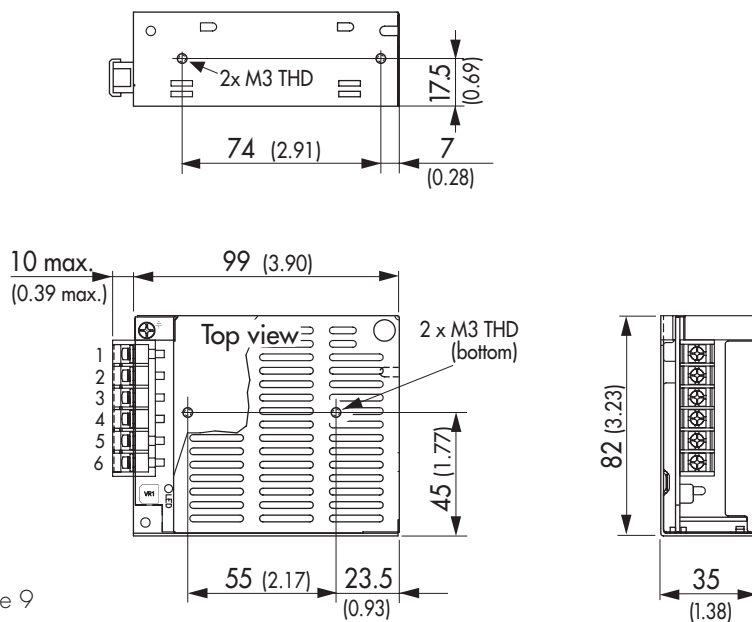

Tolerances and max. screw penetration see page 9

Case Dimensions

Case E

Connection			
	Single	Dual	Triple
1	AC L	AC L	AC L
2	AC N	AC N	AC N
3	AC FG	AC FG	AC FG
4	-Vout	No con.	-Vout 3*
5	-Vout	No con.	+Vout 3*
6	+Vout	-Vout 1	-Vout 1
7	+Vout	+Vout 1	+Vout 1
8	-	-Vout 2	-Vout 2
9	-	+Vout 2	+Vout 2

* Opposite polarity for TXL 060-0534TI

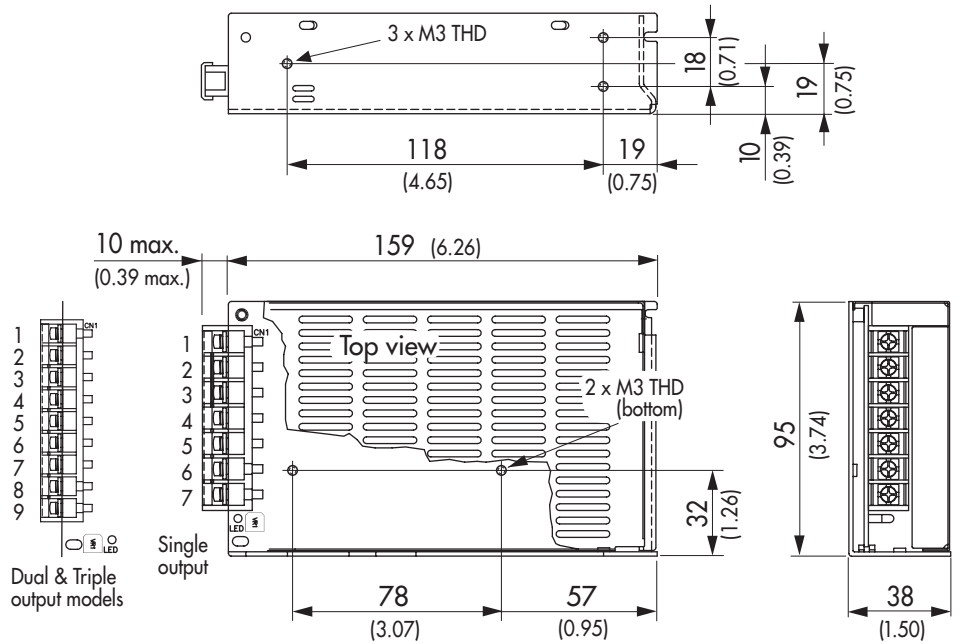

Weight: 0.7 kg (25 oz)

Case J

Connection			
	Single	Dual	Triple
1	AC L	AC L	AC L
2	AC N	AC N	AC N
3	AC FG	AC FG	AC FG
4	-Vout	No con.	-Vout 3*
5	-Vout	No con.	+Vout 3*
6	+Vout	-Vout 1	-Vout 1
7	+Vout	+Vout 1	+Vout 1
8	-	-Vout 2	-Vout 2
9	-	+Vout 2	+Vout 2

* Opposite polarity for TXL 100-0534TI

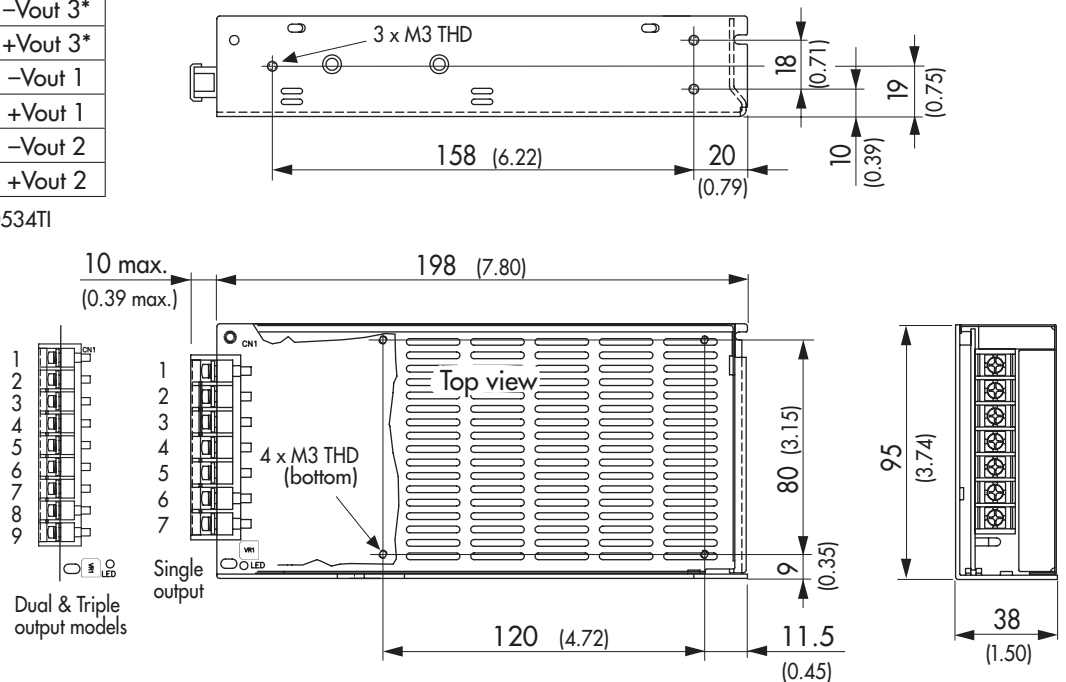

Weight: 0.8 kg (28 oz)

Tolerances and max. screw penetration see page 9

Case Dimensions

Case K

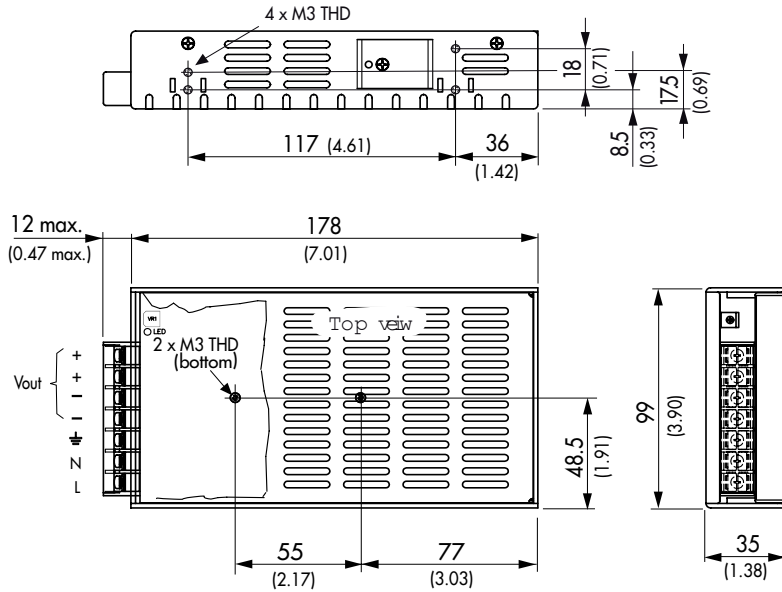

Weight: 0.82 kg (29 oz)

Case L

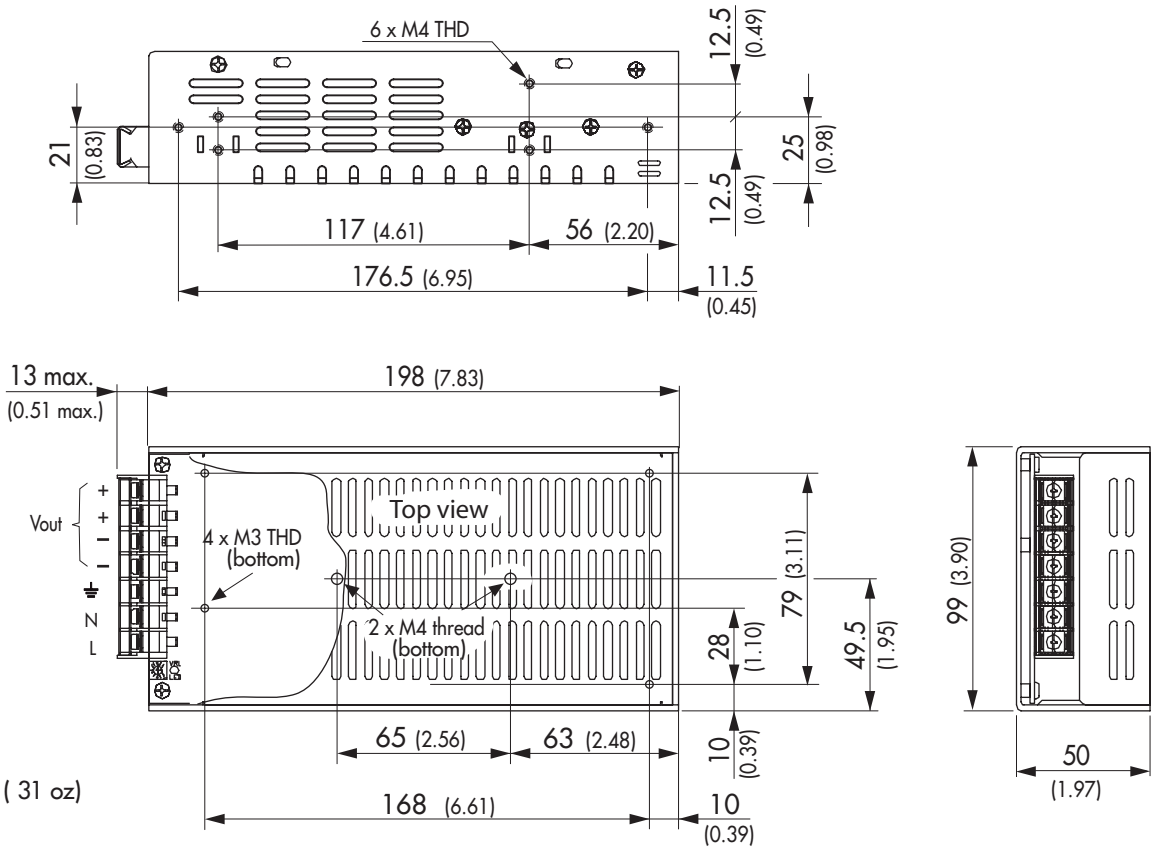

Weight: 0.89 kg (31 oz)

Tolerances and max. screw penetration see page 9

Outline Dimensions

Case N

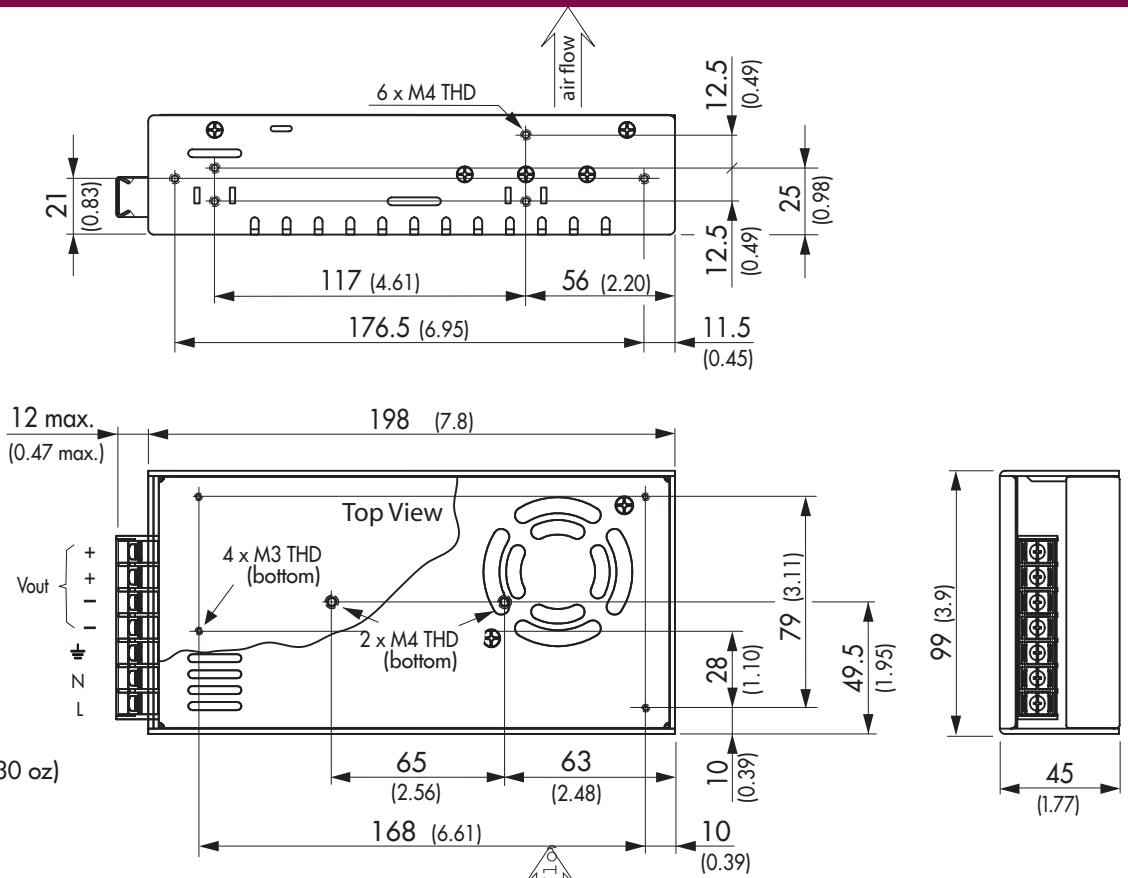

Weight: 0.86 kg (30 oz)

Case O

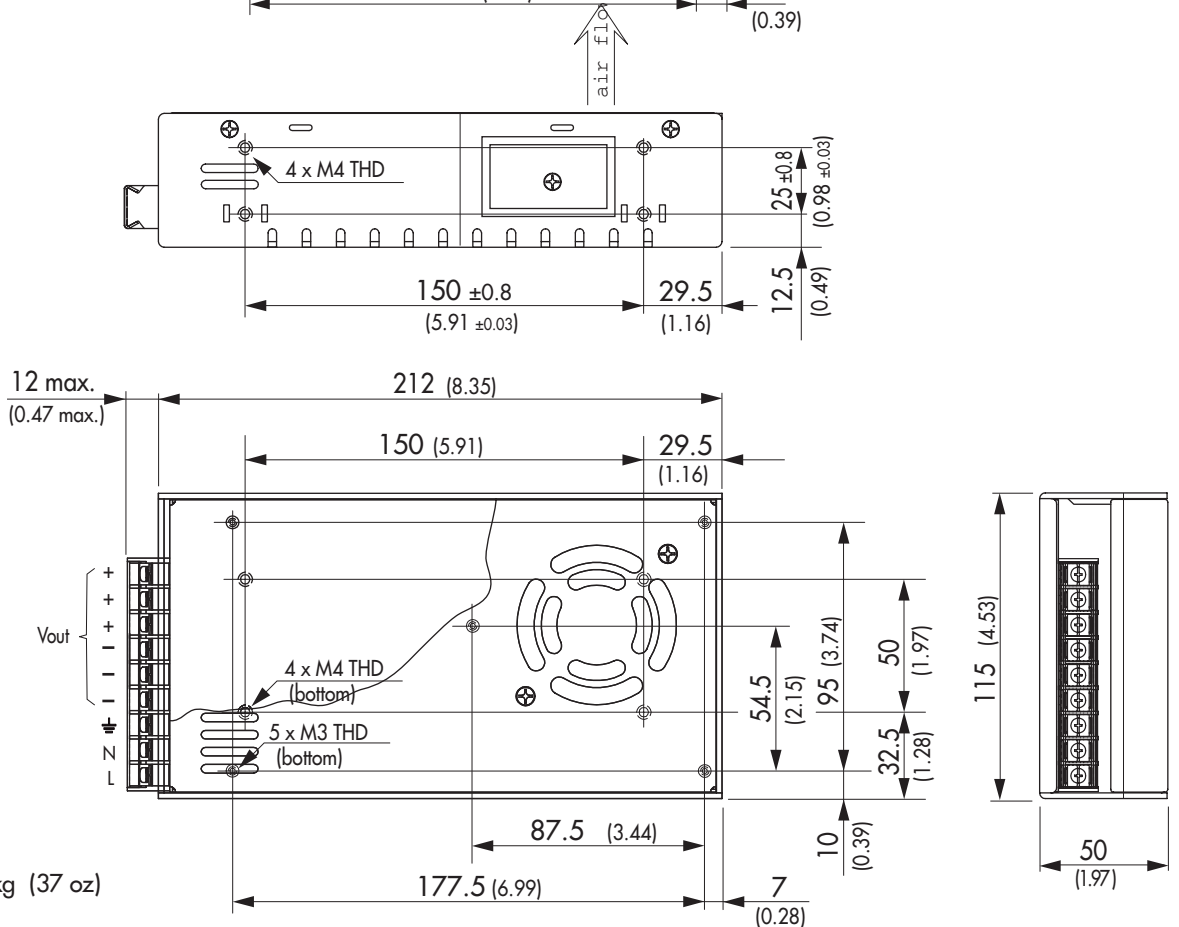

Weight: 1.05 kg (37 oz)

Tolerances and max. screw penetration see page 9

Outline Dimensions

Case P

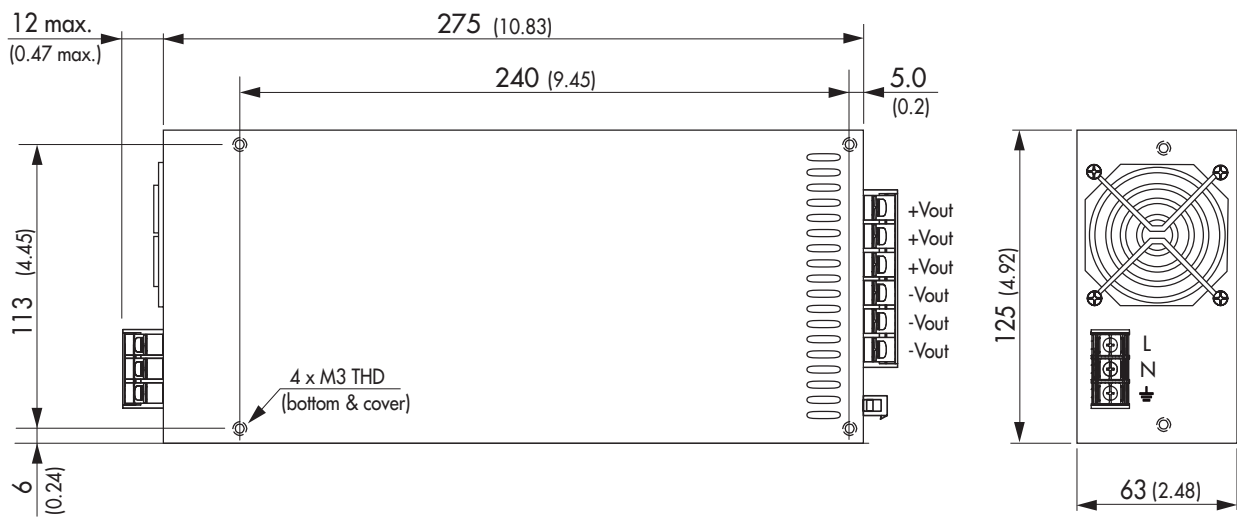
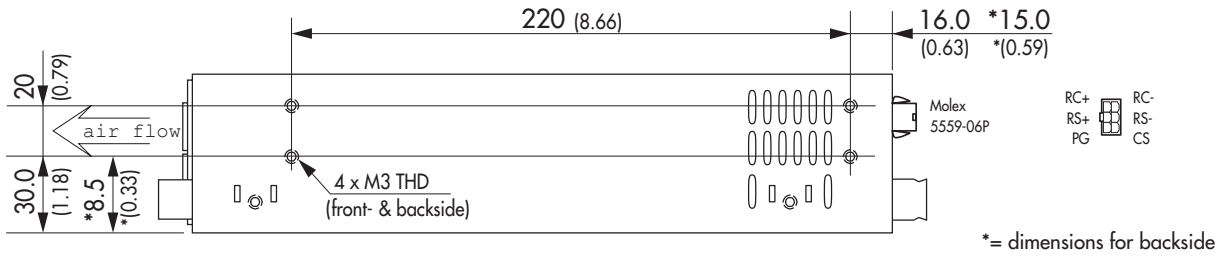

Weight: 2.3 kg (81 oz)

Molex Connector	
RC	Remote Control On/Off: RC+/RC-: 0–0.7 V = On 3–5 V = Off. Sink Current: 3–10 mA.
RS	Remote Sense Can be open or connected to the load under regard of polarity
PG	Power Good Signal: High level TTL signal within 100–500 ms after power On
CS	Current Sharing: For parallel operation

Caution! Max mounting screw penetration: 3.0 mm (0.12)

All specifications valid at nominal input voltage, full load and +25°C after warm-up time unless otherwise stated.

Outline Dimensions

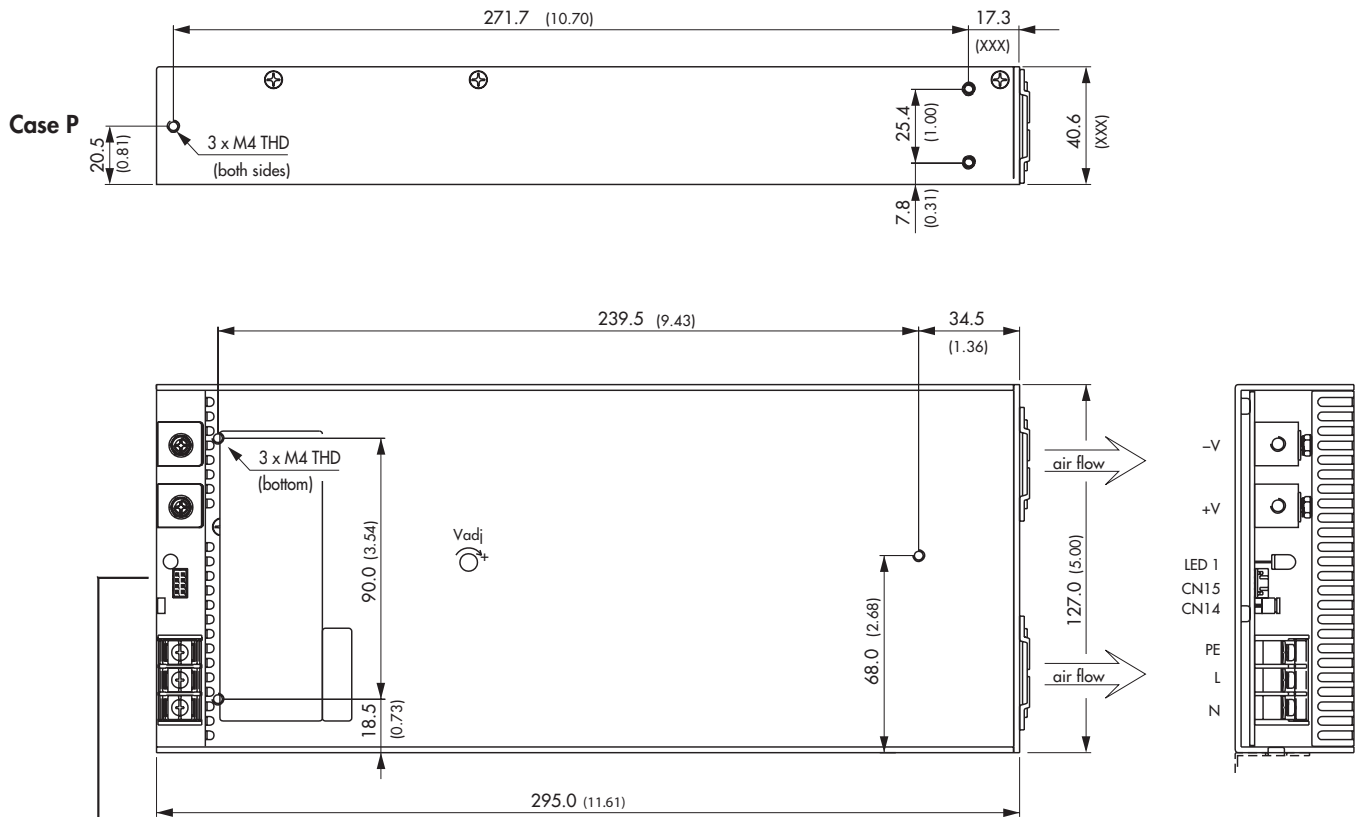

- CN14 Jumper on CN14 disables the Remote Off function
- CN15 On/Off (pin 4 & 6): Contact closed = Power On, Contact open = Power Off
- CN15 -S/+S (pin 1 & 2): Remote sense to be connected at load side under regard of polarity
- CN15 5V_Aux (pin 3 & 8): Auxiliary output 5 VDC / 0.5 A
- CN15 DC_OK (pin 5 & 8): TTL signal 0 - 1 VDC = DC-Off, 3.3 - 5.6 VDC = DC-OK
- CN15 CS (pin 7): Current Sharing to interconnect up to 4 units at parallel operation
Max power = units x 0.9, max deviation of voltage adjustment among units = 100mV

Parallel operation:

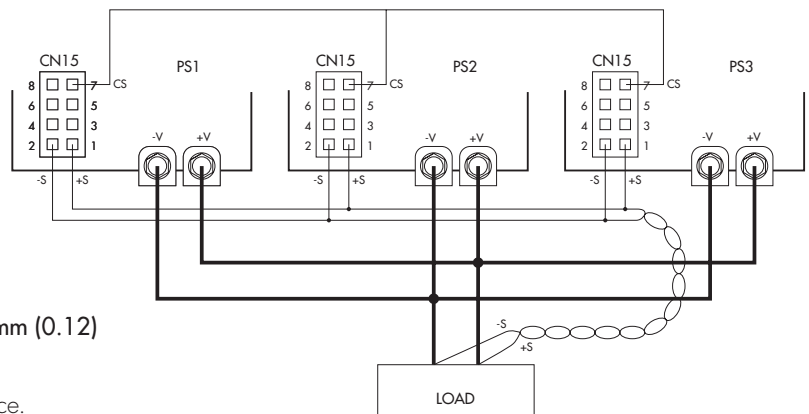

Dimensions in [mm], () = Inch
Tolerances ±0.8 (±0.03)
Mounting hole pitch tolerances ±0.5 (±0.02)

Caution! Max mounting screw penetration: 3.0 mm (0.12)

Specifications can be changed any time without notice.