

Data sheet | Item number: 858-508

Relay module; Nominal input voltage: 230 VAC; 4 changeover contacts;
 Limiting continuous current: 5 A; with manual operation; Red status indicator;
 Module width: 31 mm; 1,50 mm²

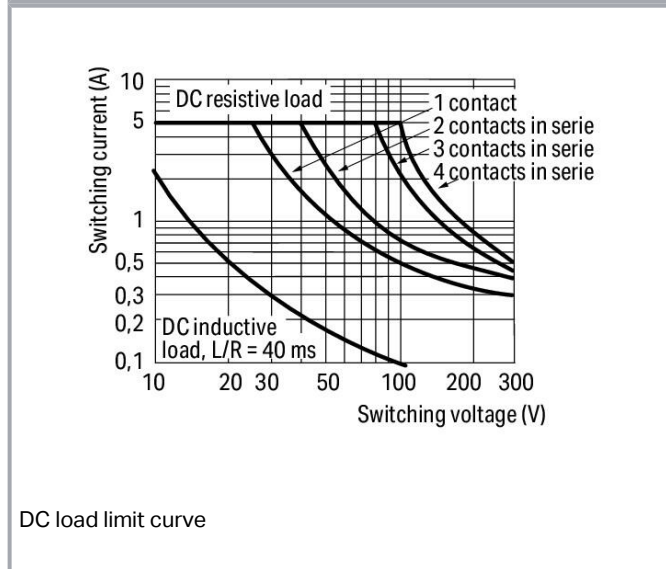

www.wago.com/858-508

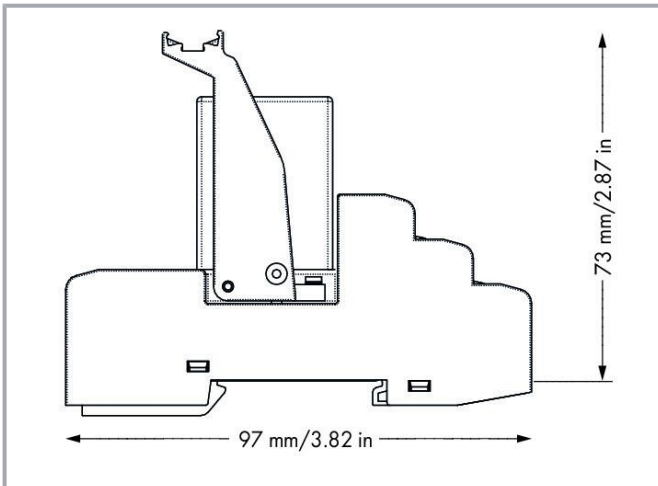
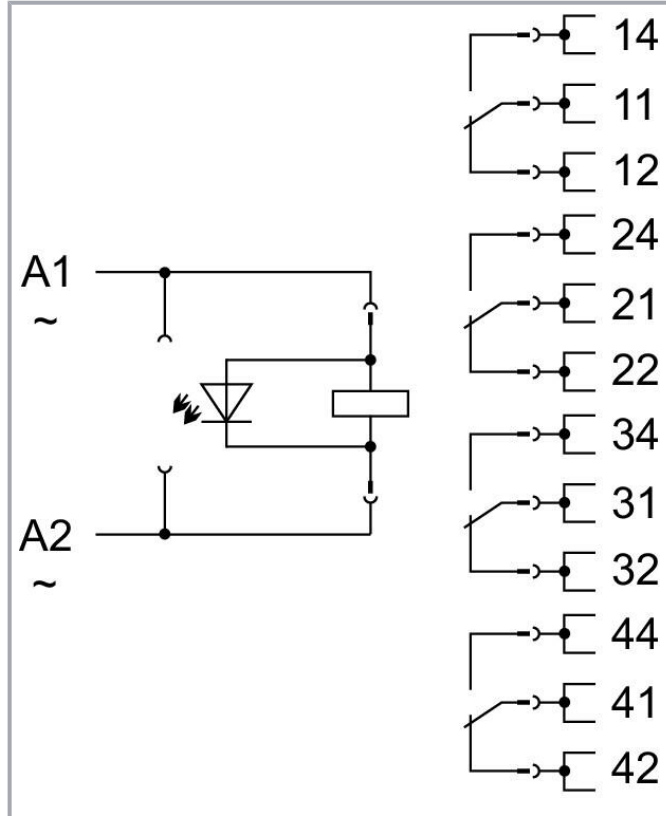
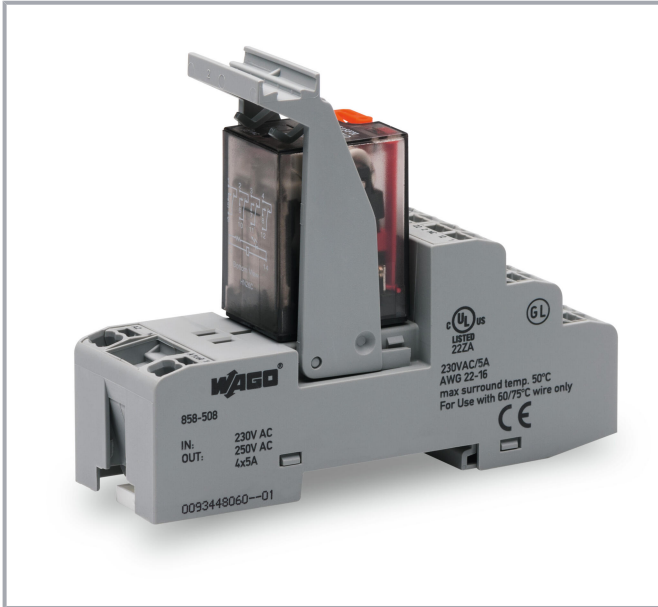

Subject to changes. Please also observe the further product documentation!

WAGO GmbH & Co. KG
 Hansastr. 27
 32423 Minden
 Phone: +49571 887-0 | Fax: +49571 887-169
 Email: info.de@wago.com | Web: www.wago.com

Do you have any questions about our products?
 We are always happy to take your call at +49 (571) 887-44222.

Data

Technical data

Control Circuit

Nominal input voltage U_N	AC 230 V
Input voltage range	-20 ... +10 %
Nominal input current at U_N	9 mA

Load circuit

Number of changeover/switchover contacts	4
Contact material (relay)	AgCe
Limiting continuous current	5 A
Inrush current (resistive) max.	(AC) 15 A / 4 s
Switching voltage (max.)	AC 250 V
Switching power (resistive) max.	AC 1250 VA; DC (see load limit curve)
Switching capacity	AC-15: 1 A / AC 240 V; DC-13: 2 A / DC 24 V
Recommended minimum load	12 V / 100 mA
Pull-in time (typ.)	25 ms
Drop-out time (typ.)	35 ms
Bounce time (typ.)	4 ms
Electrical life (NO; resistive load; 23 °C)	100 x 10 ³ switching operations
Mechanical life	20 x 10 ⁶ switching operations

Signaling

Status indicator	Red LED Mechanical
------------------	-----------------------

Safety and protection

Rated voltage	300 V
Rated surge voltage	2.5 kV
Overvoltage category	II
Pollution degree	2
Dielectric strength (control/load circuit) (AC, 1 min)	1.5 kVrms
Dielectric strength (open contact) (AC, 1 min)	1 kVrms
Dielectric strength (load/load circuit) (AC, 1 min)	1.5 kVrms

Subject to changes. Please also observe the further product documentation!



Insulation type (control/load circuit)	Basic insulation
Insulation type (open contact)	Functional insulation
Insulation type (load/load circuit)	Basic insulation
Insulation type (adjacent devices)	Reinforced insulation (safe isolation)
Protection type	IP20

Connection data

Connection technology	Push-in CAGE CLAMP®
Solid conductor	0.34 ... 1.5 mm ² / 22 ... 16 AWG
Fine-stranded conductor	0.34 ... 1.5 mm ² / 22 ... 16 AWG
Strip length	9 ... 10 mm / 0.35 ... 0.39 inches
Note (conductor cross-section)	2 x 0.34 ... 2 x 1.5 mm ² / 1 x 2.5 mm ² / 2 x 22 ... 2 x 16 AWG

Physical data

Width	31 mm / 1.22 inches
Height	97 mm / 3.819 inches
Depth from upper-edge of DIN-rail	73 mm / 2.874 inches

Mechanical data

Mounting type	DIN-35 rail
Mounting position	horizontal (standing/lying); vertical

Material Data

Fire load	0.567 MJ
Weight	97.1 g

Environmental requirements

Ambient temperature (operation at U _N)	-25 ... +70 °C
Ambient temperature UL (operation at U _N)	-25 ... 50 °C
Surrounding air temperature (storage)	-40 ... +70 °C
Processing temperature	-25 ... +50 °C
Temperature range of connection cable	≥ (T _{ambient} + 25 K)
Relative humidity	5 ... 85 %
Operating altitude (max.)	2000 m

Subject to changes. Please also observe the further product documentation!

Standards and specifications

Standards/specifications	EN 61010-2-201 EN 61810-1 EN 61373 UL 508 (max. 50 °C) DNV
--------------------------	--

Basic relay

WAGO Basic Relay	858-151
------------------	---------

Commercial data

Product Group	6 (INTERFACE ELECTRONIC)
eCl@ss 10.0	27-37-16-01
eCl@ss 9.0	27-37-16-01
ETIM 8.0	EC001437
ETIM 7.0	EC001437
PU (SPU)	5 (1) pcs
Packaging type	box
Country of origin	CN
GTIN	4055143568340
Customs tariff number	85364900990

Approvals / Certificates

General approvals

Logo	Approval	Additional Approval Text	Certificate name
	EAC Brjansker Zertifizierungsstelle	TP TC 004/2011	EAC RU C-DE.AM02.B.00122 /19

Approvals for marine applications

Logo	Approval	Additional Approval Text	Certificate name
	PRS Polski Rejestr Statków	-	TE/2186 /880590 /18

Subject to changes. Please also observe the further product documentation!

Optional accessories

Mounting

Socket without relay



Item no.: 858-110

Ejector; for basic relays 25 mm x 35 mm

www.wago.com/858-110

Jumpers

Jumper



Item no.: 858-402

Jumper; 2-way; insulated; light blue

www.wago.com/858-402

Marking accessories

Marking strip



Item no.: 2009-110

Marking strips; for Smart Printer; on reel; not stretchable; plain; snap-on type; white

www.wago.com/2009-110

Double marker carrier



Item no.: 209-128

Adaptor; gray

www.wago.com/209-128

Marking devices



Item no.: 210-110

Fiber-tip pen

www.wago.com/210-110

Protective marker cover



Item no.: 209-184

Protection cover; transparent

www.wago.com/209-184

Marker



Item no.: 2009-115

WMB-Inline; for Smart Printer; 1500 pieces on roll; stretchable 5 - 5.2 mm; plain; snap-on type; white

www.wago.com/2009-115



Item no.: 209-183

Marker; white

www.wago.com/209-183



Item no.: 793-501

WMB marking card; as card; not stretchable; plain; snap-on type; white

www.wago.com/793-501



Item no.: 793-502

WMB marking card; as card; MARKED; 1 ... 10 (10x); not stretchable; Horizontal marking; snap-on type; white

www.wago.com/793-502



Item no.: 793-503

WMB marking card; as card; MARKED; 11 ... 20 (10x); not stretchable; Horizontal marking; snap-on type; white

www.wago.com/793-503

Subject to changes. Please also observe the further product documentation!

WAGO GmbH & Co. KG

Hansastr. 27











32423 Minden

Phone: +49571 887-0 | Fax: +49571 887-169

Email: info.de@wago.com | Web: www.wago.com





Do you have any questions about our products?

We are always happy to take your call at +49 (571) 887-44222.

	Item no.: 793-504 WMB marking card; as card; MARKED; 21 ... 30 (10x); not stretchable; Horizontal marking; snap-on type; white	www.wago.com/793-504
	Item no.: 793-505 WMB marking card; as card; MARKED; 31 ... 40 (10x); not stretchable; Horizontal marking; snap-on type; white	www.wago.com/793-505
	Item no.: 793-506 WMB marking card; as card; MARKED; 41 ... 50 (10x); not stretchable; Horizontal marking; snap-on type; white	www.wago.com/793-506
	Item no.: 793-566 WMB marking card; as card; MARKED; 1 ... 50 (2x); not stretchable; Horizontal marking; snap-on type; white	www.wago.com/793-566
	Item no.: 793-5501 WMB marking card; as card; for terminal block width 5 - 17.5 mm; stretchable 5 - 5.2 mm; plain; snap-on type; white	www.wago.com/793-5501
Group marker carrier		
	Item no.: 209-145 Group marker carrier; white	www.wago.com/209-145
	Item no.: 249-105 Group marker carrier; gray	www.wago.com/249-105
Tool		
Operating tool		
	Item no.: 210-719 Operating tool; Blade: 2.5 x 0.4 mm; with a partially insulated shaft	www.wago.com/210-719
Basic Relay		
Basic relay		
	Item no.: 858-151 Basic relay; Nominal input voltage: 230 VAC; 4 changeover contacts; Limiting continuous current: 5 A; with manual operation; Module width: 22 mm; Module height: 25 mm	www.wago.com/858-151
Indicators		
Status indication		
	Item no.: 788-125 Accessories for relay modules; Operation status indicator: red	www.wago.com/788-125
Filter Module		
Suppressor module		
	Item no.: 788-148 Filter module; RC filter element; Nominal voltage: 230 VAC	www.wago.com/788-148

Subject to changes. Please also observe the further product documentation!

Ferrule

Ferrule		
	Item no.: 216-241 Ferrule; Sleeve for 0.5 mm ² / 20 AWG; insulated; electro-tin plated; electrolytic copper; gastight crimped; acc. to DIN 46228, Part 4/09.90; white	www.wago.com/216-241
	Item no.: 216-242 Ferrule; Sleeve for 0.75 mm ² / 18 AWG; insulated; electro-tin plated; electrolytic copper; gastight crimped; acc. to DIN 46228, Part 4/09.90; gray	www.wago.com/216-242
	Item no.: 216-243 Ferrule; Sleeve for 1 mm ² / AWG 18; insulated; electro-tin plated; electrolytic copper; gastight crimped; acc. to DIN 46228, Part 4/09.90; red	www.wago.com/216-243
	Item no.: 216-244 Ferrule; Sleeve for 1.5 mm ² / AWG 16; insulated; electro-tin plated; electrolytic copper; gastight crimped; acc. to DIN 46228, Part 4/09.90; black	www.wago.com/216-244

Downloads

Documentation

Bid Text

858-508 docx - Datei	Feb 20, 2019	docx 17.4 kB	Download
858-508 X81 - Datei	Feb 19, 2019	xml 4.8 kB	Download

Instruction Leaflet

Stecksocket für Elementarrelais	V 2.0.0 Jan 25, 2022	pdf 2.2 MB	Download
---------------------------------	-------------------------	---------------	----------

Additional Information

Disposal and Recycling Electrical and electronic equipment, Batteries, Packaging	V 1.1.0 Aug 18, 2022	pdf 2.2 MB	Download
---	-------------------------	---------------	----------

CAD/CAE-Data

CAD data

2D/3D Models 858-508	URL	Download
----------------------	-----	----------

CAE data

EPLAN Data Portal 858-508	URL	Download
---------------------------	-----	----------

Subject to changes. Please also observe the further product documentation!

WSCAD Universe 858-508

[URL](#)

[Download](#)

ZUKEN Portal 858-508

[URL](#)

[Download](#)

Environmental Product Compliance

Compliance Search

Environmental Product Compliance 858-508

[URL](#)

[Download](#)

Relay module; Nominal input voltage: 230 VAC; 4 changeover contacts; Limiting continuous current: 5 A; with manual operation; Red status indicator; Module width: 31 mm; 1,50 mm²

Installation Notes

Commoning

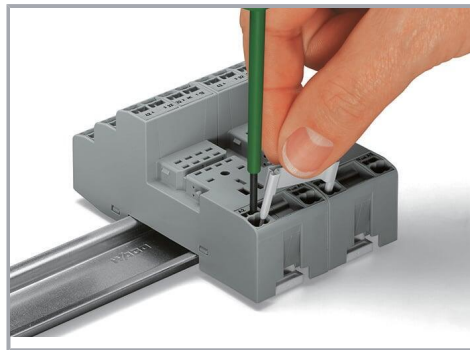
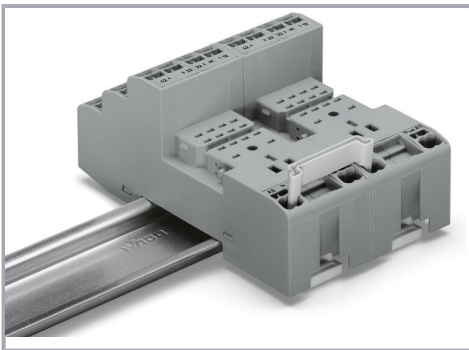

Removing a jumper via screwdriver.

Marking

Subject to changes. Please also observe the further product documentation!

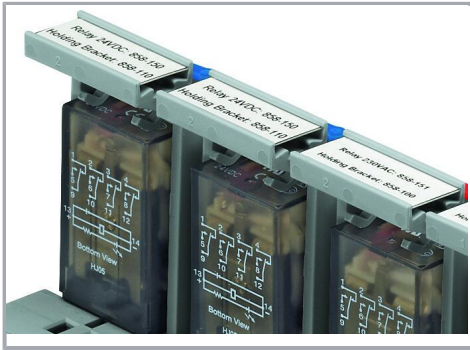

Marking using WMB Multi markers and group marker carriers.

Subject to changes. Please also observe the further product documentation!