

## Solid State Relay

### KSI240 Series Single Phase AC Output



- Zero switching or instant-on
- Ratings from 10A to 100A @ 48-280VAC
- Triac or SCR output for heavy industrial loads
- AC or DC input
- Superior thermal performance
- Dielectric strength:  $\geq 2500\text{VACrms}$
- LED indication
- Internal RC/MOV and TVS protection circuit as option

#### Product Description

KSI240 series industrial single phase relay with triac or SCR output is the most widely used in industry application. The relay can be used for resistive, inductive and capacitive loads. The control input voltage is 4-32VDC or 85-280VAC, output current rate 10A, 25A, 40A, 60A, 80A, 100A @ 48-280VAC.

#### Product Selection

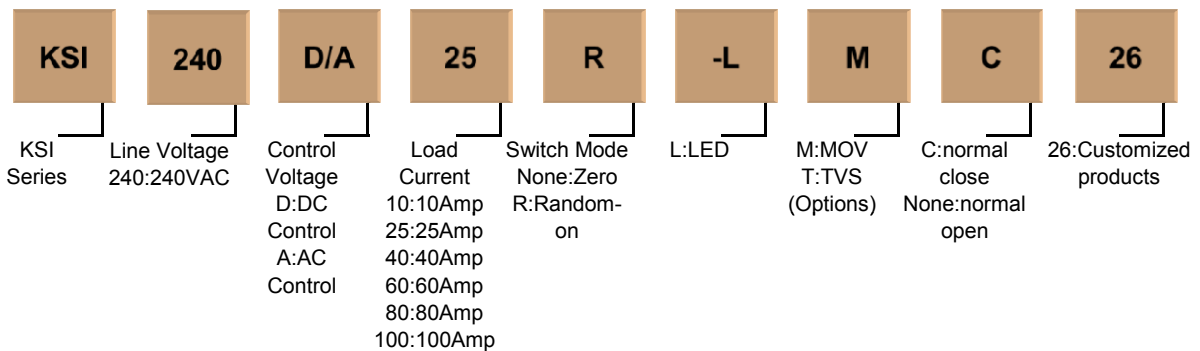

Description	10A	25A	40A	60A	80A	100A
D:4-32VDC	KSI240D10	KSI240D25	KSI240D40	KSI240D60	KSI240D80	KSI240D100
	KSI240D10R	KSI240D25R	KSI240D40R	KSI240D60R	KSI240D80R	KSI240D100R
AC:85-280VAC	KSI240A10	KSI240A25	KSI240A40	KSI240A60	KSI240A80	KSI240A100

#### Technical Specification

##### Input Circuit

Control Voltage Range	DC Input	4-32VDC
	AC Input	85-280VAC
Minimum Turn-On Voltage	DC Input	4VDC
	AC Input	85VAC
Minimum Turn-Off Voltage	DC Input	1VDC
	AC Input	10VAC
Maximum Input Current	DC Input	25mA
	AC Input	10mA

<b>Output Circuit</b>		
Load Voltage Range	48-280VAC	
Maximum Turn-On Time	DC Input Random-On	100 $\mu$ s
	DC Input Zero-On	1/2AC Cycle + 1ms
Maximum Turn-Off Time	AC Input	20ms
	DC Input	1/2AC Cycle + 1ms
Maximum Surge Current [@10ms]	AC Input	40ms
	10A	400A
	25A	600A
	40A	640A
	60A	860A
	80A	1280A
Transient Overvoltage	100A	1550A
	600Vpk	
Maximum Off-State Leakage Current [@ Rated Voltage]	5mA	
Maximum On-State Voltage Drop [@ Rated Current]	1.3Vrms	
Minimum Off-State dv/dt [@ Maximum Rated Voltage]	500V/ $\mu$ s	

<b>General Information</b>	
Dielectric Strength, Input/Output/Base [50/60Hz]	$\geq$ 4000Vrms / 2500Vrms
Ambient Operating Temperature Range	-30 $^{\circ}$ C ~ +80 $^{\circ}$ C
Ambient Storage Temperature Range	-30 $^{\circ}$ C ~ +100 $^{\circ}$ C
Weight [typical]	85g

**Application**  
High-low Temperature Chamber, Plastics Machinery, Incubation Machine, Oiling Machine, HVAC, Elevator, Lighting, Fountain Controller.

**Installation**

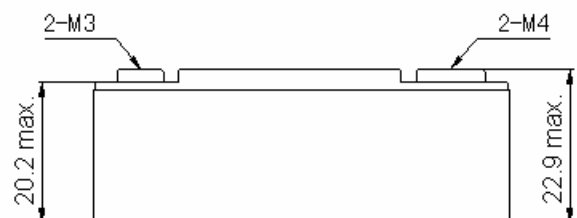
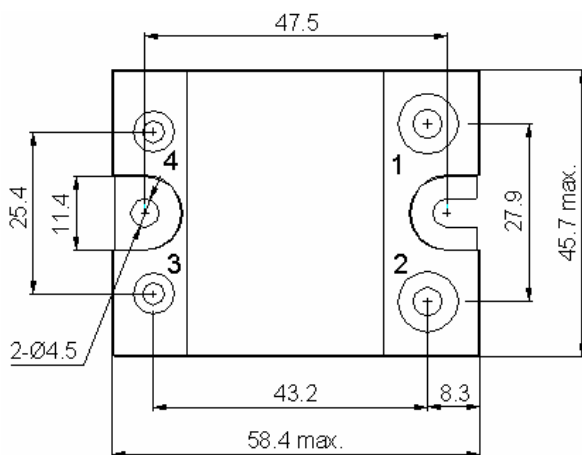

## Thermal Curve

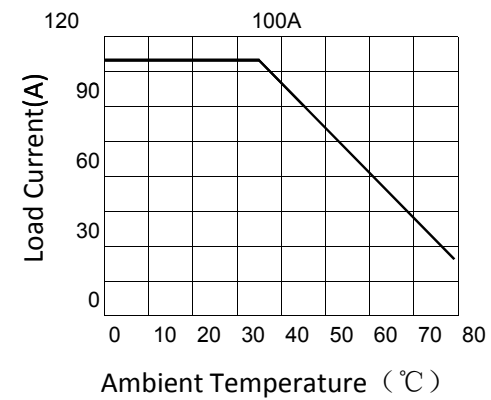
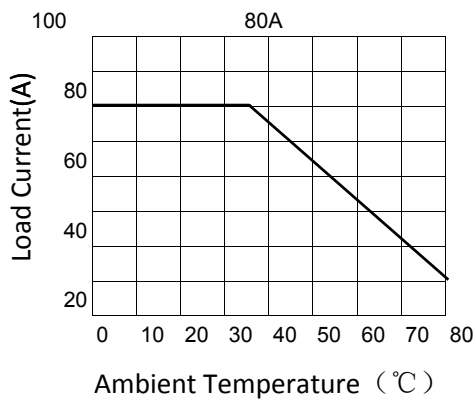
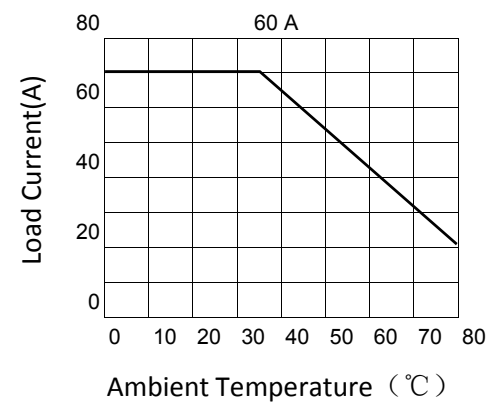
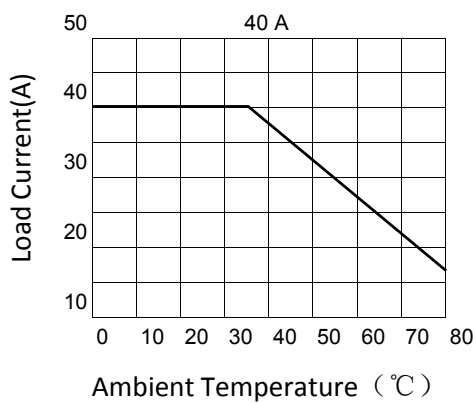
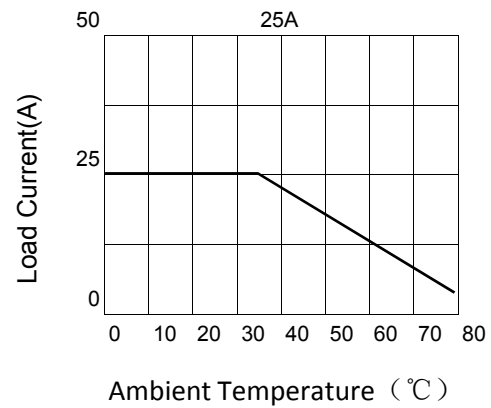
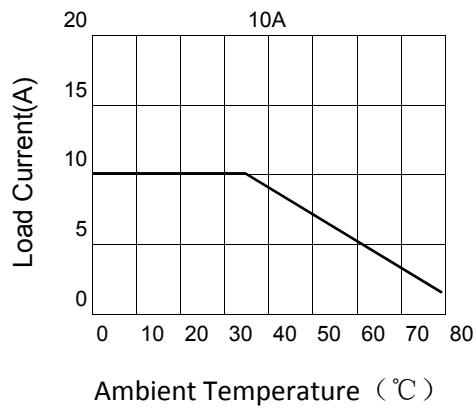

### Important Notice

1. When the ambient temperature is over 40°C or many KSI series are installed closely together, the user should take load discount into account according to the thermal curve.
2. If the load current is over 10A, suitable heatsink should be added to the SSR.

### Product Certification

