

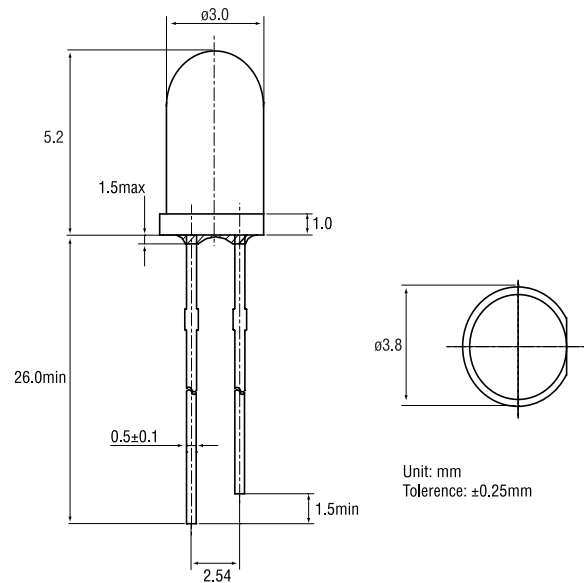

### Outline dimensions:



### Features:

- High power LED
- 3mm Standard directivity
- Superior weather-resistance
- UV Resistant epoxy
- Water clear type

### Applications:

- Automotive dashboard lighting
- Back lighting

### Absolute maximum rating (Ta=25°C)

Item	Symbol	Value	Unit
DC Forward current	$I_F$	50	mA
Pulse forward current*	$I_{FP}$	120	mA
Reverse voltage	$V_R$	5	V
Power dissipation	$P_D$	120	mW
Operating temperature	$T_{opr}$	-30 to +85	°C
Storage temperature	$T_{stg}$	-40 to +100	°C
Lead soldering temperature	$T_{sol}$	260°C/5 sec	-

\* Pulse width max. 10ms Duty ratio max 1/10

### Directivity:

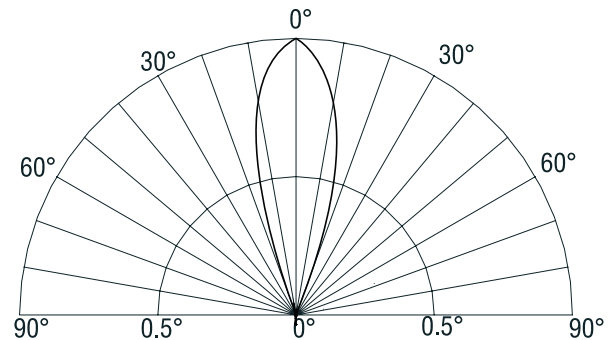

### Electrical - Optical characteristics (Ta=25°C)

Item	Symbol	Condition	Min.	Typ.	Max.	Unit
DC Forward voltage	$V_F$	$I_F = 20\text{mA}$	1.8	2.0	2.4	V
DC Reverse current	$I_R$	$V_R = 5\text{V}$	-	-	10	$\mu\text{A}$
Dom. wavelength	$\lambda_D$	$I_F = 20\text{mA}$	585	590	595	nm
Luminous intensity	$I_V$	$I_F = 20\text{mA}$	2180	3000	4200	mcd
50% Power angle	$2\theta_{1/2}$	$I_F = 20\text{mA}$	-	30	-	deg