

Features:

- High luminous LEDs
- 1.8 ϕ Standard directivity
- Superior weather resistance
- UV resistant epoxy
- Water clear type

Applications

- General purpose indicators
- Small area illuminations
- Back lighting



Absolute maximum rating (Ta=25°C)

Item	Symbol	Value	Unit
DC forward current	I_F	30	mA
Pulse forward current*	I_{FP}	100	mA
Reverse voltage	V_R	5	V
Power dissipation	P_D	78	mW
Operating temperature	T_{opr}	-30 to +85	°C
Storage temperature	T_{stg}	-40 to +100	°C
Lead soldering temperature	T_{sol}	260°C/5 sec	-

*Pulse width max. 10ms. Duty ratio max. 1/10

Electrical - Optical characteristics (Ta=25°C)

Item	Symbol	Condition	Min.	Typ.	Max.	Unit
DC Forward voltage	V_F	$I_F = 20\text{mA}$	1.8	2.0	2.4	V
DC Reverse current	I_R	$V_R = 5\text{V}$	-	-	10	μA
Domi. wavelength	λ_D	$I_F = 20\text{mA}$	620	625	630	mcd
Luminous intensity	I_V	$I_F = 20\text{mA}$	750	1120	1560	mcd
50% Power angle	$2\theta_{1/2}$	$I_F = 20\text{mA}$	-	30	-	deg

Outline dimensions:

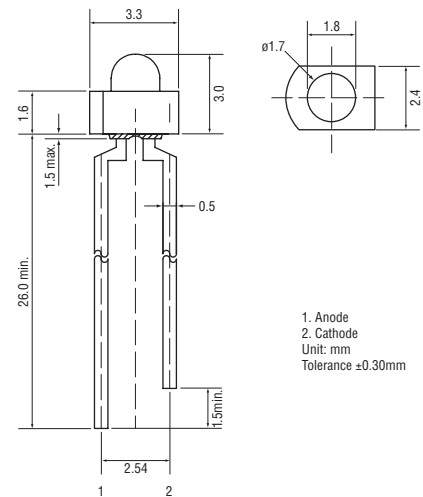

Directivity:

