

## Features:

- High luminous LEDs
- 3mm Round standard directivity
- Long lifetime operation
- Superior weather-resistance
- Water clear type

## Applications

- Backlighting (switches, keys, displays, illuminated advertising etc.)
- Substitution of micro incandescent lamps
- Reading lamps/emergency lighting
- Marker lights (e.g. steps, exit ways, etc.)
- Other lighting

## Absolute maximum rating (Ta=25°C)

Item	Symbol	Value	Unit
DC Forward current	$I_F$	30	mA
Pulse forward current*	$I_{FP}$	100	mA
Reverse voltage	$V_R$	5	V
Power dissipation	$P_D$	108	mW
Operating temperature	$T_{opr}$	-30 to +85	°C
Storage temperature	$T_{stg}$	-40 to +100	°C
Lead soldering temperature	$T_{sol}$	260°C/5sec	-

\* Pulse width max. 10ms Duty ratio max. 1/10

## Electrical – Optical characteristics (Ta=25°C)

Item	Symbol	Condition	Min.	Typ.	Max.	Unit
DC Forward voltage	$V_F$	$I_F = 20\text{mA}$	2.8	3.1	3.6	V
DC Reverse current	$I_R$	$V_R = 5\text{V}$	-	-	10	$\mu\text{A}$
Luminous flux*	$\Phi_V$	$I_F = 20\text{mA}$	7.0	7.5	-	lm
Chromaticity coordinates <sup>†</sup>	x	$I_F = 20\text{mA}$	-	0.34	-	
	y	$I_F = 20\text{mA}$	-	0.37	-	
50% Power angle	$2\theta_{1/2}$	$I_F = 20\text{mA}$	-	30	-	deg

\* Luminous flux measurement allowance is  $\pm 15\%$

<sup>†</sup> Chromaticity coordinates measurement allowance is  $\pm 10\%$



## Outline dimensions:

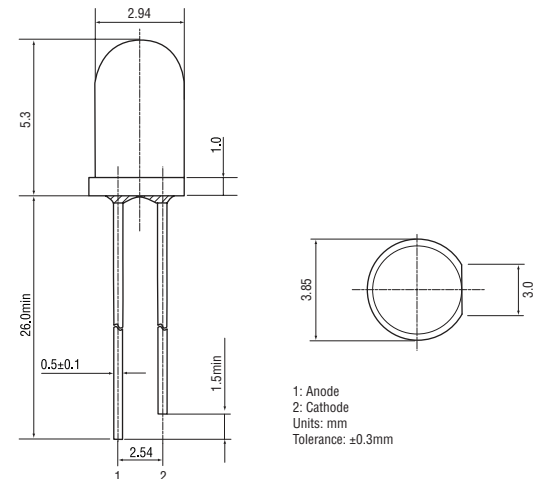

## Directivity:

