

Features:

- High luminous LEDs
- 5mm Round standard directivity
- Long lifetime operation
- Superior weather-resistance
- Water clear type

Applications

- Backlighting (switches, keys, displays, illuminated advertising etc.)
- Substitution of micro incandescent lamps
- Reading lamps/emergency lighting
- Marker lights (e.g. steps, exit ways, etc.)
- Other lighting

Absolute maximum rating (Ta=25°C)

| Item | Symbol | Value | Unit |
|----------------------------|-----------|-------------|------|
| DC Forward current | I_F | 30 | mA |
| Pulse forward current* | I_{FP} | 100 | mA |
| Reverse voltage | V_R | 5 | V |
| Power dissipation | P_D | 108 | mW |
| Operating temperature | T_{opr} | -30 to +85 | °C |
| Storage temperature | T_{stg} | -40 to +100 | °C |
| Lead soldering temperature | T_{sol} | 260°C/5sec | - |

* Pulse width max. 10ms Duty ratio max. 1/10

Electrical – Optical characteristics (Ta=25°C)

| Item | Symbol | Condition | Min. | Typ. | Max. | Unit |
|---------------------------------------|-----------------|---------------------|------|-------|------|---------------|
| DC Forward voltage | V_F | $I_F = 20\text{mA}$ | 2.8 | 3.1 | 3.6 | V |
| DC Reverse current | I_R | $V_R = 5\text{V}$ | - | - | 10 | μA |
| Luminous flux* | Φ_V | $I_F = 20\text{mA}$ | 6.0 | 6.7 | - | lm |
| Chromaticity coordinates [†] | x | $I_F = 20\text{mA}$ | - | 0.208 | - | |
| | y | $I_F = 20\text{mA}$ | - | 0.256 | - | |
| 50% Power angle | $2\theta_{1/2}$ | $I_F = 20\text{mA}$ | - | 15 | - | deg |

* Luminous flux measurement allowance is $\pm 15\%$

[†] Chromaticity coordinates measurement allowance is $\pm 10\%$

Outline dimensions:

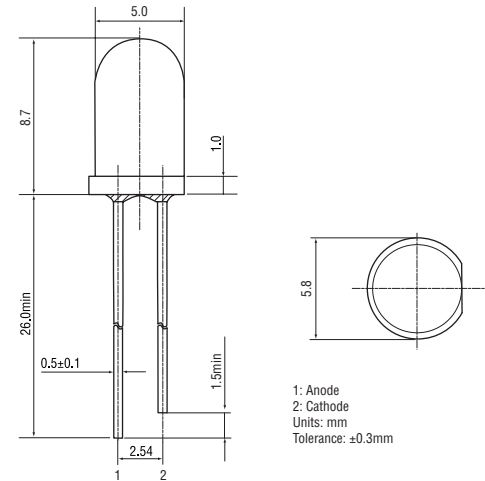

Directivity:

