

User's Manual

Handheld Double-Pressure-Meter

GMH 3151

as of Version 7.0

for GMSD, GMXD, MSD and MXD - Pressure Sensors



WEEE-Reg.-Nr. DE 93889386

CONTENTS

1	GENERAL NOTE	3
2	SAFETY	3
2.1	INTENDED USE.....	3
2.2	SAFETY SIGNS AND SYMBOLS.....	3
2.3	SAFETY GUIDELINES.....	3
3	PRODUCT SPECIFICATION	4
3.1	SCOPE OF SUPPLY	4
3.2	OPERATION AND MAINTENANCE ADVICE	4
4	HANDLING	5
4.1	DISPLAY	5
4.2	BASIC OPERATION	5
4.3	CONNECTIONS	6
4.4	POP-UP CLIP.....	6
5	START OPERATION	7
6	CONFIGURATION	7
7	REMARKS TO SPECIAL FEATURES	8
7.1	DIFFERENT KINDS OF MEASURING: „RATE-SLO, -P.DET, -FAST“	8
7.1.1	rAtE-Slo: Standard Measuring	8
7.1.2	rAtE-P.dEt: Peak detection	8
7.1.3	rAtE-FASt: Fast filtered measuring.....	8
7.2	MEASURING OF WATER LEVEL – DISPLAY UNIT [M]	8
7.3	SEA LEVEL CORRECTION FOR ABSOLUTE PRESSURE SENSORS.....	8
7.4	AVERAGING FUNCTION	9
7.5	POWER OFF TIME.....	9
7.6	ALARM	9
7.7	REAL TIME CLOCK	9
8	OPERATION OF LOGGER	10
8.1	„FUNC-STOR“: STORING SINGLE MEASUREMENTS	10
8.2	„FUNC-CYCL“: AUTOMATIC RECORDING WITH SELECTABLE LOGGER-CYCLE-TIME	11
9	OUTPUT	12
9.1	SERIAL INTERFACE.....	12
9.2	ANALOGUE OUTPUT – SCALING WITH DAC.0 AND DAC.1	13
10	INPUT ADJUSTMENT	13
10.1	ZERO DISPLACEMENT SENSOR ('OFFS').....	13
10.2	SCALE CORRECTION SENSOR ('SCAL').....	13
10.3	CALIBRATION SERVICES	13
11	PRESSURE CONNECTION	13
11.1	ABSOLUTE PRESSURE SENSORS (TYPES: GMSD/GMXD...BA)	13
11.2	RELATIVE PRESSURE SENSORS (TYPES: GMSD/GMXD...MR, GSMD/GMXD...BR).....	13
11.3	STAINLESS STEEL PRESSURE SENSORS (TYPES: GMSD/GMXD...MRE, GMSD/GMXD...BRE, GMSD/GMXD...BAE AND MSD/MXD...MRE, MSD/MXD...BRE, MSD/MXD...BAE WITH MSD-K31).....	14
12	ERROR AND SYSTEM MESSAGES	14
13	SPECIFICATION	15
14	RESHIPMENT AND DISPOSAL	16
14.1	RESHIPMENT	16
14.2	DISPOSAL INSTRUCTIONS	16

1 General Note

Read this document carefully and get used to the operation of the device before you use it. Keep this document within easy reach near the device for consulting in case of doubt.

Mounting, start-up, operating, maintenance and removing from operation must be done by qualified, specially trained staff that have carefully read and understood this manual before starting any work.

The manufacturer will assume no liability or warranty in case of usage for other purpose than the intended one, ignoring this manual, operating by unqualified staff as well as unauthorized modifications to the device. The manufacturer is not liable for any costs or damages incurred at the user or third parties because of the usage or application of this device, in particular in case of improper use of the device, misuse or malfunction of the connection or of the device.

The manufacturer is not liable for misprints.

2 Safety

2.1 Intended Use

This device must only be used with one "GMSD... - K31" or "MSDE" pressure sensors. Other usages are not intended.

The safety requirements (see below) have to be observed.

The device must be used only according to its intended purpose and under suitable conditions.

Use the device carefully and according to its technical data (do not throw it, strike it, ...)

Protect the device from dirt.

2.2 Safety signs and symbols

Warnings are labeled in this document with the followings signs:



Caution! This symbol warns of imminent danger, death, serious injuries and significant damage to property at non-observance.



Attention! This symbol warns of possible dangers or dangerous situations which can provoke damage to the device or environment at non-observance.



Note! This symbol point out processes which can indirectly influence operation or provoke unforeseen reactions at non-observance.

2.3 Safety guidelines

This device has been designed and tested in accordance with the safety regulations for electronic devices. However, its trouble-free operation and reliability cannot be guaranteed unless the standard safety measures and special safety advises given in this manual will be adhered to when using the device.

1. Trouble-free operation and reliability of the device can only be guaranteed if the device is not subjected to any other climatic conditions than those stated under "Specification".

If the device is transported from a cold to a warm environment condensation may cause in a failure of the function. In such a case make sure the device temperature has adjusted to the ambient temperature before trying a new start-up.

2.



If there is a risk whatsoever involved in running it, the device has to be switched off immediately and to be marked accordingly to avoid re-starting.

Operator safety may be a risk if:

- there is visible damage to the device

- the device is not working as specified
 - the device has been stored under unsuitable conditions for a longer time.
- In case of doubt, please return device to manufacturer for repair or maintenance.

3. When connecting the device to other devices the connection has to be designed most thoroughly as internal connections in third-party devices (e.g. connection GND with protective earth) may lead to undesired voltage potentials that can lead to malfunctions or destroying of the device and the connected devices.



This device must not be run with a defective or damaged power supply unit.
Danger to life due to electrical shock!

4.  Do not use these products as safety or emergency stop devices or in any other application where failure of the product could result in personal injury or material damage. Failure to comply with these instructions could result in death or serious injury and material damage.

5.  This device must not be used at potentially explosive areas! The usage of this device at potentially explosive areas increases danger of deflagration, explosion or fire due to sparking.

3 Product Specification

3.1 Scope of supply

The scope of supply includes:

- Measuring device with 9V battery
- Operation manual

3.2 Operation and maintenance advice

1. Battery operation:

If 'bAt' is shown in the lower display the battery has been used up and needs to be replaced. However, the device will operate correctly for a certain time. If 'bAt' is shown in the upper display the voltage is too low to operate the device; the battery has been completely used up.



***The battery has to be taken out, when storing device above 50 °C.
We recommend taking out battery if device is not used for a longer period of time.
After recommissioning the real-time clock has to be set again.***

2. Mains operation with power supply



When using a power supply please note that operating voltage has to be 10.5 to 12 V DC. Do not apply overvoltage!! Cheap 12V-power supplies often have excessive no-load voltage. We, therefore, recommend using regulated voltage power supplies.

Trouble-free operation is guaranteed by our power supply GNG10/3000.

Prior to connecting the power supply to the mains make sure that the operating voltage stated at the power supply is identical to the mains voltage.

3. Treat device and sensor carefully. Use only in accordance with above specification. (do not throw, hit against etc.). Protect plug and socket from soiling.
4. Connecting/changing sensors
-  Use only sensors of GMSD ... - K31 or MSD - series!
Other sensors may lead to damage to the device and the sensor.
Switch off device before changing the sensor..

4 Handling

4.1 Display

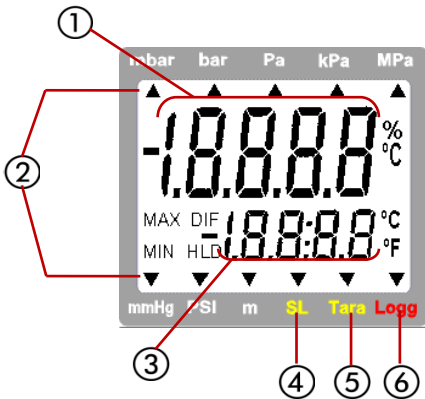

- 1 **Main display:** shows measuring value

- 2 Arrow points to the chosen measuring **unit**

- 3 **Secondary display:** shows min-, max- or hold value

- 4 **SL:** appears if sea-level-correction is activated

- 5 **Tara:** appears if tara-function is activated

- 6 **Logg:** appears if logger function is chosen, flashes while logger is running

4.2 Basic Operation

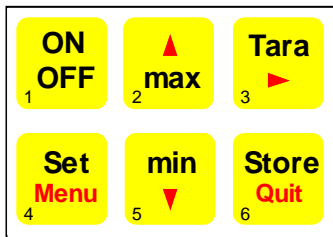

On / Off



min/max bei Messung:

press short: shows the min./max. value

+

press again: hides min./max. value



press 2 sec.: clears particular value

Tara, zero-point adjustment:

press short: display will be set to 0



The following measuring will be relatively displayed to the set tara value

press 2 sec.: deactivates tara-function

press 5 sec.: Zero-Point Adjustment¹⁾



Set/Menu:

press short: Calling of configuration

Store/Quit:

press short: hold-function, the last measuring value will be held in the secondary display.



press again: hides the value

at active logger: invokes logger functions

Please Note: Activating/deactivating tara clears the max- & min-memories.

¹⁾ **Zero-Point Adjustment:** If there is no pressure or zero-pressure (absolute) applied to the pressure ports the device will display 0. If there is a permanent deviation (and device is operated under steady conditions), a permanent zero point adjustment can be carried out. To carry out the adjustment press button 3 for approx. 5 seconds (Auto Null will be displayed shortly). The adjustment is done via the OFFSET-value of the sensor (referring configuration menu).
To recall the manufacturer's calibration press button 3 for approx. 15 seconds.

Please note: - A zero-point adjustment can only be carried out if the difference between the value on display is less than 500 digits!
- If a zero point adjustment was carried out the display shows "Corr" after a restart .

4.3 Connections

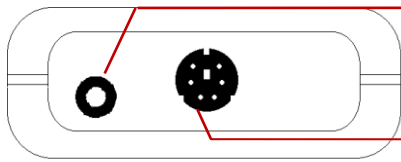

Output: Connection for optically isolated interface adapter or for analog output (please refer to chapter 9)

Connection for pressure sensors of the GMSD, GMSD or MSD and MXD-family

Power supply: the mains adapter socket is located at the left side of the device.

4.4 Pop-up clip

Handling:

- Pull at label "open" in order to swing open the pop-up clip.
- Pull at label "open" again to swing open the pop-up clip further.

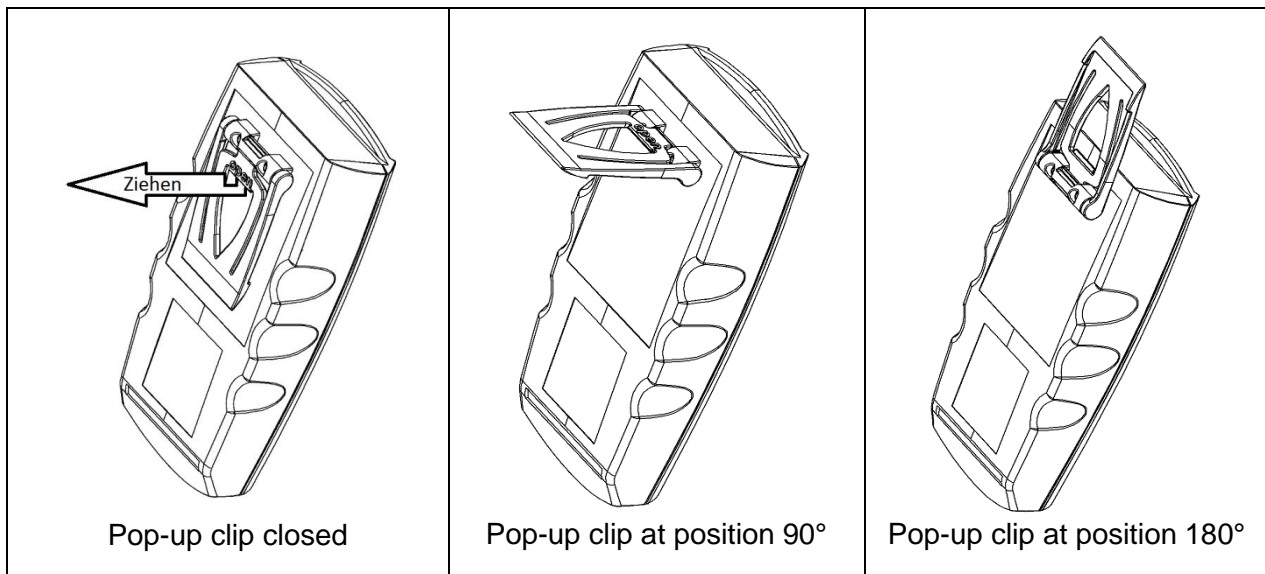

Function:

- The device with a closed pop-up clip can be plainly laid onto a table or attached to a belt, etc.
- The device with pop-up clip at position 90° can be set up on a table, etc.
- The device with pop-up clip at position 180° can be suspended from a screw or the magnetic holder GMH 1300.

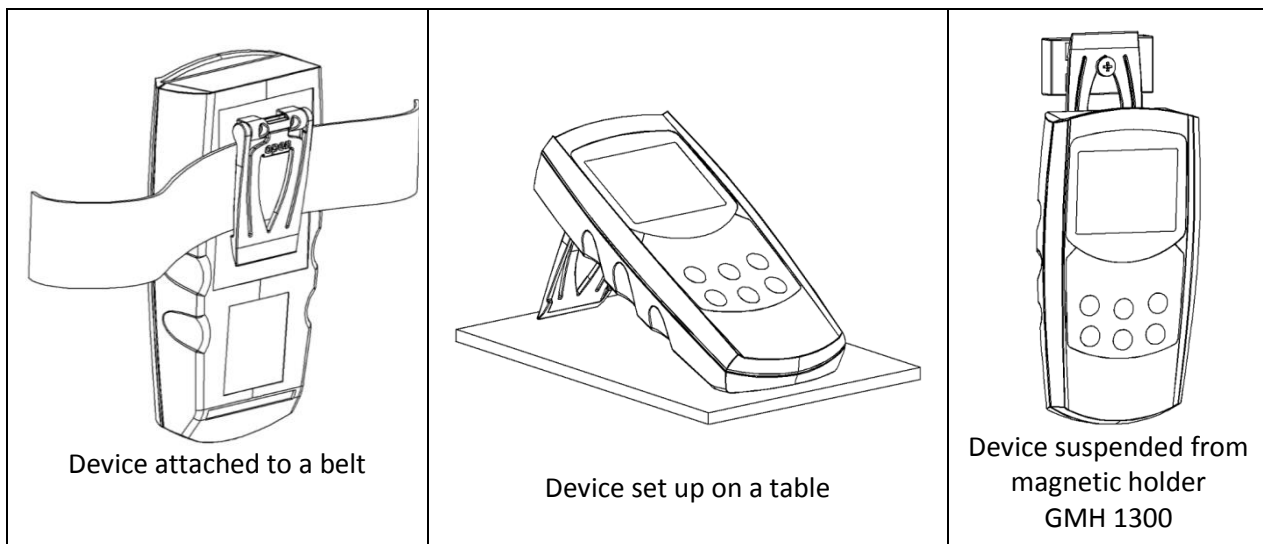

5 Start Operation

Connect sensor, turn on device via  key.



After segment test the device displays some configuration:



- If the logger function is not off the time of the integrated clock will shortly be displayed.
- If a **zero point adjustment** was carried out the display shows shortly „nuLL Corr“.

After changing the battery the clock-setting menu is activated automatically („CLOC“). Check the clock and adjust, if necessary (p.r.t. chapter 6).

After that the device is ready for measuring.

6 Configuration



To change device settings, press **Menu** (key 4) for 2 seconds. This will call the configuration menu (main display: „SEt“).

Pressing key **Menu** changes between the menus, pressing  (key 3) jumps to the referring parameters, which can be selected with key  (key 3).

The parameters can be changed with  (key 2) or  (key 5).

Pressing **Menu** again jumps back to the main configuration menu and saves the settings.

Quit (key 6) finishes the configuration and returns to standard measuring operation.

Menu	Parameter	Values	Meaning	
KEY Menu	KEY 	KEY  or 		
SEt ConF	Set Configuration: Generic Configurations			
	Unit	mbar, bar..	Unit: Unit of display	*
	SL	oFF/on	Sea level correction: on or off	*
	Alti	-2000..9999	Altitude above sea level [m] (only if SL)	*
	rAtE		Rate: Measuring rate (p.r.t. chapter 7)	*
		Slo	Slow measuring rate (4Hz filtered, low power consumption)	*
		FASt	Fast measuring rate, filtered (>1000Hz)	*
		P.dEt	Peak detection: fast measuring rate, unfiltered (>1000Hz)	*
	t.AVG	1-120	Averaging period in seconds, used by the averaging function	
		oFF	Averaging function deactivated	
	P.oFF	1-120	Auto Power Off time in minutes	
		oFF	Auto Power Off deactivated	
	Out	oFF	Function of the output: No output function, lowest power consumption	
		SEr	Output is serial interface	
		dAC	Output is analogue output 0...1V	
	Adr.	01, 11..91	Base address of interface (if Out = SEr)	
	dAC.0	eg. -5.00..5.00 mbar	Enter desired value at which the analogue output potential should be 0V (if Out = dAC)	
	dAC.1	eg. -5.00..5.00 mbar	Enter desired value at which the analogue output potential should be 1V (if Out = dAC)	
SEt CAL	Set Calibration: Adjustment of Sensor			
	OFFS	Sensordep., e.g. -5.00..5.00 mbar	The offset of sensor will be displaced by this value to compensate for deviations in the probe or in the measuring device.	
		oFF	Zero displacement inactive (=0.0°)	
	SCAL	-2.000...2.000	The measuring scale of sensor will be changed by this factor [%] to compensate deviations of temperature probe or measuring device	
		oFF	Scale correction factor inactive (=0.000)	
SEt AL.	Set Alarm: Settings Of Alarm Function			
	AL.	On	Alarm on, with buzzer sound	
		no.So	Alarm on, without buzzer sound	
		oFF	no alarm function	
	AL.Lo	Sensor-Min...	Min alarm rail (not when AL. oFF)	
		AL.Hi	Sensor-Min is the lower display range of sensor	
	AL.Hi	AL.Lo... Sensor-	Max alarm rail (not when AL. oFF)	
		Max	Sensor-Max is the upper display range of sensor	

SEt	Set Logger: Configuration Of Logger Function			*
LoGG	Func	CYCL	Cyclic: logger function ,cyclic logger'	*
		Stor	Store: logger function ,individual value logger'	*
		oFF	no logger function	*
	CYCL	1..3600	Cycle time of cyclic logger [seconds]	*
	Lo.Po	on/oFF	Low-power logger with very low power consumption (only for cyclic logger and slow measuring rate)	*
SEt	Set Clock: Setting Of Real Time Clock			
CLOC	CLOC	HH:MM	Clock: Setting of time	hours:minutes
	dAtE	TT.MM	Date:	day.month
	YEAr	YYYY	Year	

C_log: cyclic logger (active)

C_dat: cyclic logger with data (no active logging)

C_stor: individual value logger with data

Note: (*) When using the logger function some settings in the menu may not be accessible. If this settings should be changed, the logger has to be stopped before, eventually the logger data has to be cleared. (p.r.t. chapter 8)

7 Remarks To Special Features

7.1 Different Kinds Of Measuring: „rAtE-Slo, -P.dEt, -FASt“

Three different kinds of measuring pressure are supported. Two of them are working with high measuring frequency of more than 1000 measurings per second. If one of them was chosen in the configuration (see above), this will be displayed in the secondary display: „P.dEt“ or „FASt“.

7.1.1 rAtE-Slo: Standard Measuring

Measuring rate 4Hz, averaging and filter functions are active.

Application: Measuring of slowly changing or static pressures, e.g. measuring of leakproofness, atmospheric pressure...

Highest accuracy, high noise immunity (EMI and unstable measuring signals), low power consumption.

7.1.2 rAtE-P.dEt: Peak detection

Measuring rate >1000Hz, the value is displayed unfiltered.

Application with logger function: Measuring of short pressure peaks or fast changing pressures with a resolution of < 1 ms. The cyclic logger function records the arithmetic mean value, the highest and the lowest peak of the referring time interval.

Attention: higher power consumption, measuring is sensitive to noise (EMI,..).

7.1.3 rAtE-FASt: Fast filtered measuring

Measuring rate >1000Hz, the value is filtered slightly (higher noise immunity than P.dEt, small peaks will be filtered out), apart from that identical behaviour like P.dEt.

7.2 Measuring Of Water Level – Display Unit [m]

When using suitable waterproof pressure sensors the unit [m] for meters of water can be set in the menu "Unit". 10m of water are roughly 1 bar over pressure. Measurings can be made e.g. like described below :

- With one abs. pressure sensor (SL oFF!): Press ‚Tara‘ when sensor is at ambient air and then bring sensor to the depth to be measured. The display shows now the depth in [m].
- With one rel. pressure sensor: bring tube connection for lower press. in contact to ambient air by means of a tube (no water contact!) and bring the sensor with its open press. connection for higher pressure to water depth to be measured (display and is compensated for pressure changes in ambient air).

7.3 Sea Level Correction for Absolute Pressure Sensors

The device displays the absolute pressure. This is not necessarily the same like the values given by weather stations! The weather stations' values are giving the pressure at sea level. Usually the sensor is placed above sea level and therefore, if the value at sea level(zero) is to be measured, the pressure loss resulting from the actual level above sea level has to be considered! To correct the measuring display activate the „Sea-Level-Function“ (SL, p.r.t. chapter 6, setting is only possible, if the abs. pressure sensor is connected to sensor socket 1). Then enter the altitude above sea level of the sensor's location in meters (Alti, p.r.t. chapter 6). When activated, the display shows the SL-arrow and the device displays the pressure value at sea level.

7.4 Averaging Function

The averaging function concerns the display values (LCD and interface). It is completely independent from the averaging of the logger function, please don't mix them up!

The averaging integrates the measuring values during a selectable period of time and then calculates the average display value. It is independent from the selected kind of measuring (slow, fast, peak detect).

As long as not enough values are collected (selected averaging time) to calculate a average value, the upper display shows "----", the lower display a 'countdown'.

During an active low-power-logging procedure the averring is always deactivated

Function of min/max-value memory during averaging:

- If averaging is activated and slow measuring is selected (rAtE-Slo), the min-/max-value memory refers to the average display value.
- If averaging is activated and fast measuring is selected (rAtE-FASt or P.dEt) , the min-/max-value memory refers to the internal measured values (fast peaks can be detected).

7.5 Power off Time

If there won't be pressed any key and no interface communication takes place for the time of the power off time setting (P.Off), the device will be switched off automatically to save battery power.

If P.oFF = oFF then the automatic switch off is deactivated.

7.6 Alarm

There are three possible settings: Alarm off (AL. oFF), on with horn sound (AL. on), on without horn sound (AL. no.So).

Following conditions will display an alarm, when the function is activated (on or no.So):

- Value is below lower (AL. Lo) or above upper alarm rail (AL.Hi).
- Sensor error (Sens Erro)
- Low battery (bAt)
- Fe 7: System error (always with sound)

In case of an alarm and when polling the interface the prio-flag is set in the returned interface message.

7.7 Real Time Clock

The real time clock is used for the logger function: Recorded values are also containing the point of time, when they were measured. Please check the settings when necessary.

If the battery was replaced the referring menu ,CLOC' will automatically be started.

8 Operation Of Logger

The device supports two different logger functions:

- „Func-Stor“: each time when „store“ (key 6) is pressed a measurement will be recorded.
- „Func-CYCL“: measurements will automatically be recorded each interval, which was set in the logger menu ‚CYCL‘ until the logger will be stopped or the logger memory is full. The recording is started by pressing „Store“ 2 seconds.

The logger records following measurement results each time:

current or mean value (depending on logger setting, see below), min peak and max peak of sensor

Min and max peak are the minimum resp. the maximum of the measured values since the last recording.

Using them allows f.e. analysis of fluctuating pressures. For the evaluation of the data the software GSOFT3050 has to be used. The software also allows easy configuration and starting of the logger.

When the logger is activated (Func Stor or Func CYCL) the hold function is no more available, the key 6 is solely used for the operation of the logger functions.

Please note: When reading out loggerdata either the sensor connected during logging or no sensor should be connected. Otherwise the measuring unit of the data may be corrupted.

8.1 „Func-Stor“: Storing Single Measurements

Each time when „store“ (key 6) is pressed a measurement and its time stamp will be recorded.

The recorded data can be viewed either in the display (when calling the configuration an additional menu „REAd LoGG“ is displayed, see below) or by means of the interface and a PC with GSOFT3050-software.

Please note: For the Func-Stor-logging function it is not allowed to change the pressure sensor after values are stored, otherwise invalid data could be read out.

For the read out of the logger the sensor has to be kept connected!

Max. number of measurements: 99

A measuring contains:

- current measuring value at the time of recording
- min peak since the last recording
- max peak since the last recording
- time and date of the recording

After each recording „St. XX“ will be displayed for a short time. XX represents the number of the recording.

If logger memory contains recordings already:

When „Store“ is pressed for 2 seconds, the choice for clearing the logger memory will be displayed:



Clear all recordings



Clear the last recording



Clear nothing (cancel menu)

The selection can be made by ▲ (key 2) and ▼ (key 5). "Quit" (key 6) enters the choice.

If the logger memory is full, the display will show:



Viewing Recorded Measurements

Within the „LoGG Stor“ function the measurements can be viewed directly in the display not only by means of a computer (like at „Func CYCL“): press 2 seconds „Set“ (key 4): The first menu displayed now is „rEAd LoGG“ (read logger data). After pressing ▶ (key 3) the measurement recorded last will be displayed, changing between the different values referring to the measurement also is done by pressing ▶.

Changing the measurement is done by pressing the keys ▲ or ▼.

8.2 „Func-CYCL“: Automatic Recording With Selectable Logger-Cycle-Time

The Logger-Cycle-Time is settable (p.r.t. Configuration). For example „CYCL“ = 60: A measuring is recorded after each 60 seconds.

When the slow measurement "rAtE-Slo" is chosen, additionally a low power function is available: „Lo.Po“. If „Lo.Po“ is on, the device only will take a measurement at the point of time of the recording. In between the recordings the measuring shuts down. This decreases the power consumption enormously and therefore is recommended e.g. for long time recordings where no mains adapter is available.

Max. number of measurings: 10000

Cycle time: 1...3600 seconds (=1h), selectable in the configuration

A measuring contains:

- slow measuring rate (rAtE Slo):
 - **current measuring value** at the time of recording
 - **min peak, max peak** since the last recording
- fast measuring rates (rAtE FASt,P.dEt):
 - **arithmetic mean value** since the last recording
 - **min peak, max peak** since the last recording

By pressing "Store" (key 6) for 2 seconds the logger operation will be called. The display will show:



By pressing "Store" again the recording will be initiated.

After that the display shows 'St.XXXX' for a short time whenever a measuring is recorded.

XXXX is the number of the measuring 1..10000.

If the logger memory is full, the display will show:



The recording automatically will be stopped.

If Low-Power-Logger-Function „Lo.Po = on“ the device switches itself off as soon as the memory gets filled.

Stopping the recording manually:

By pressing "Store" (key 6) the recording can be stopped manually. Then the following choice appears:



Stop the recording



Do not stop the recording

The selection can be made by ▲ (key 2) and ▼ (key 5). "Quit" (key 6) enters the choice.

Note: If you try to switch off the instrument in the cyclic recording operation you will be asked once again if the recording is to be stopped.

The device can only be switched off after the recording has been stopped!

The Auto-Power-Off-function is deactivated during recording!

Clear Recordings:

By pressing "Store" (key 6) for 2 seconds the logger operation will be called.

The display will show:



By pressing the keys ▲ (key 2) or ▼ (key 5) the display will change to



When „Store“ is pressed, the choice for clearing the logger memory will be displayed:



Clear all recordings



Clear the last recording sequence



Clear nothing (cancel menu)

The selection can be made by ▲ (key 2) and ▼ (key 5). "Quit" (key 6) enters the choice.

9 Output

The output can be used as serial interface (for USB 3100, USB 3100 N, GRS 3100 or GRS 3105 interface adapters) or as analog output (0-1V).

If none of both is needed, we suggest to switch the output off, because battery life then is extended.

9.1 Serial Interface

By means of the serial interface and a suitable electrically isolated interface adapter (USB 3100, USB 3100 N, GRS 3100 or GRS 3105) the device can be connected to a computer for data transfer.

With the GRS 3105 up to 5 devices of the GMH3xxx- series can be connected to one interface (see also manual of GRS 3105). As a precondition the base addresses of all devices must not be identical, make sure to configure the base addresses accordingly (refer menu point "Adr." in chapter 6).

To avoid transmission errors, there are several security checks implemented e.g. CRC.

The following standard software packages are available:

- **GSOFT3050:** Operation and read out of logger function, data display in diagrams and tables
- **GMHKonfig:** Software for a comfortable editing of the device (e.g. Material selection...)
- **EBS 20M / 60M:** 20-/60-channel software to display the measuring values

In case you want to develop your own software we offer a **GMH3000-development package** including:

- a universally applicable Windows functions library ('GMH3000.DLL') with documentation that can be used by the most programming languages. Suitable for Windows XP™, Windows Vista™, Windows 7™
- Programming examples Visual Basic 4.0™, Delphi 1.0™, Testpoint™

In addition to the operation at a PC the device can be operated with the **GAM 3000** device, to use the alarm function for simple supervision and controlling applications. Just connect a GAM 3000 to the interface, activate the alarm function of the GMH and the relays output is operating.

The device has 3 channels:

- Channel 1: current measuring value (base address)
- Channel 2: min peak (p.r.t. chapter 8)
- Channel 3: max peak (p.r.t. chapter 8)

Note: *The measuring-/ alarm- and display range values read back from the interface are always in the selected measurement unit (mbar, bar...)!*

Supported functions:

Channel	Code	Name/Function	Channel	Code	Name/Function
1 2,3			1 2,3		
x x	0	Read measurement value	x	208	Read # of channels
x x	3	Read system state	x	222	Read power off time (Conf-P.oFF)
x	12	Read ID number	x	223	Set power off time (Conf-P.oFF)
x	22	Read min alarm rail (AL. - AL.Lo)	x x	224	Logger: Read data of CYCL- Logger
x	23	Read max alarm rail (AL. - AL.Hi)	x	225	Logger: Read cycle time (LoGG - CYCL)
x	32	Read configuration flag BitAlarmOn: 1, BitAlarmSound:3; BitLoggerOn:50; BitCyclicLogger:51; BitLowPowerLogger:52	x	226	Logger: set cycle time (LoGG - CYCL)
			x	227	Logger: start recording
			x	228	Logger: Read # of recordings made
x	160	Set configuration flag (refer to 32)	x	229	Logger: Read state
x x	176	Read min measuring range	x	231	Logger: Read stop time
x x	177	Read max measuring range	x	233	Read real time clock (CLOC)
x x	178	Read measuring range unit	x	234	Set real time clock (CLOC)
x x	179	Read measuring range decimal point	x	236	Read logger memory size
x x	180	Read kind of measuring of sensor	x	237	Read logger filecount
			x	238	Read logger filepointer
x x	199	Read kind of measuring of display	x	239	Read logger file info
x x	200	Read min display range	x	240	Reset
x x	201	Read max display range	x	254	Program version
x x	202	Read display range - unit	x	260	Logger: read data of STOR Logger
x x	204	Read display range - decimal point	x x	263	Read logger channel info

9.2 Analogue Output – Scaling with DAC.0 and DAC.1

Note: Analogue output can not be used during logger recordings

With the DAC.0 and DAC.1 values the output can be rapidly scaled to your efforts.

Keep in mind not to connect low-resistive loads to the output, otherwise the output value will be wrong and battery life is decreased. Loads above ca 10kOhm are uncritical.

If the display exceeds the value set by DAC.1, then the device will apply 1V to the output

If the display falls below the value set by DAC.0, then the device will apply 0V to the output

In case of an error (Err.1, Err.2, no sensor, etc.) the device will apply slightly above 1V to the output.

plug wiring:

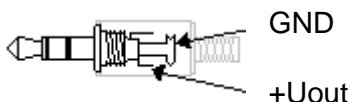

Attention!

the 3rd contact has to be left floating!

Only stereo plugs are allowed!

10 Input Adjustment

10.1 Zero Displacement Sensor ('OFFS')

A zero displacement can be carried out for the measured value:

$$\text{value displayed} = \text{value measured} - \text{offset}$$

Standard setting: 'off' = 0.0°, i.e. no zero displacement will be carried out. Together with the scale correction (see below) this factor is mainly used to compensate for sensor deviations. Input is in the display unit.

10.2 Scale Correction Sensor ('SCAL')

The scale of the measuring can be influenced by this setting (factor is in %):

$$\text{displayed value} = \text{measured value} * (1 + \text{Scal}/100)$$

Standard setting: 'off' = 0.000, i.e. value is not corrected. Together with the zero displacement (see above) this factor is mainly used to compensate for sensor deviations.

10.3 Calibration Services

Calibration certificates – DKD-certificates – other certificates:

If device should be certificated for its accuracy, it is the best solution to return it to the manufacturer.

Only the manufacturer is capable to do efficient recalibration if necessary to get results of highest accuracy!

11 Pressure Connection

The device is designed to be connected to the sensors of the GMSD/GMXD/MSD/MXD...-series without a new calibration being necessary. Therefore a great variety of replaceable sensors of e.g. -1.999...2.500 mbar relative up to 0...1000 bar absolute pressure can be connected to the device.

11.1 Absolute Pressure Sensors (types: GMSD/GMXD...BA)

Connect plastic tube with an internal dia of 4 mm to pressure port "A". (Port "B" is not used.)

11.2 Relative Pressure Sensors (types: GMSD/GMXD...MR, GSMD/GMXD...BR)

- **For measurements of over- or under pressure:**

Connect plastic tube with an internal dia of 4 mm to pressure port "B". (Port "A" is not used.)

- **For measurements of under pressure:** (with higher negative measuring range)
Connect plastic tube with internal dia of 4 mm to pressure port "B". Port "A" will not be used!
Pressure sensors GMSD 2,5 MR, GMSD 25 MR and GMSD 350 MR allow for measurements of under pressure up to the entire over pressure measuring range by re-plugging the tube to pressure port "A". Please note that all values are displayed as positive values. No minus sign will be shown. (Example for GMSD 25 MR: For tube connection "B" the measuring range covers -19.99 to 25.00 mbar. If you replug to port "A" under pressure measurements down to -25.00 mbar could be carried out with the display showing the value 25.00 (no minus sign).



Note: All values are displayed now as positive values. No minus sign will be shown.

Example: it is possible to measure under pressure down to -25.00 mbar, the display shows then the value 25.00 (no minus sign).

- **For measurements of pressure differences:**
Connect both plastic tubes with an internal dia of 4 mm to pressure port "B" and "A"; make sure to apply higher pressure to port "B".

11.3 Stainless steel pressure sensors (types: GMSD/GMXD...MRE, GMSD/GMXD...BRE, GMSD/GMXD...BAE and MSD/MXD...MRE, MSD/MXD...BRE, MSD/MXD...BAE with MSD-K31)

For measurements of over-, under- or absolute pressure screw sensor to G1/4" pressure terminal or plug plastic tube to a suitable adapter.

12 Error And System Messages

Display	Meaning	What to do?
	Low battery power, device will only continue operation for a short period of time	Replace battery
	Battery empty	Replace battery
	Mains operation without battery: wrong voltage	Check power supply, replace it when necessary
	No sensor connected	Switch off device and connect sensor
	Connected sensor or device defective	If 2nd sensor available, check if device is ok. Return defective device/sensor to manufacturer for repair
	Value extremely out of measuring range	Check: pressure not within sensor range?
No display or confused characters, device does not react on keypress	Battery empty	Replace battery
	Mains operation: wrong voltage or polarity	Check power supply, replace it when necessary
	System error	Disconnect battery and power supplies, wait shortly, then reconnect
	Device defective	Return to manufacturer for repair
Err.1	Measured value above allowable range	Check: pressure not within sensor range? -> measuring value to high!
	Sensor defective	Return to manufacturer for repair
Err.2	Measured value below allowable range	Check: pressure not within sensor range? -> measuring value to low!
	Sensor defective	Return to manufacturer for repair
Err.3	Display range overflow	Check: value above 19999 -> to high to be displayed
Err.4	Display range underflow	Check: value below -19999 (Tara?) -> to low!
Er.11	Value could not be calculated	Choose different unit
	Calculation overflow happened	Choose different unit
Err.7	System error	Return to manufacturer for repair
----	Sensor not present / recognised	reconnect sensor, during logging: stop the logger and restart it
	could not calculate value	suitable sensor / unit combination necessary

13 Specification

Measuring ranges:

Display range:	max. -19999...19999 digit, depending on connected sensor
Resolution:	depending on connected sensor
Pressure units:	mbar, bar, kPa, MPa, mmHg, PSI, mH ₂ O selectable depending on connected sensor
Accuracy: (typ.)	±0,1%FS (at nominal temperature) (FASt and P.dET: ±0.5%FS)
Measuring rate:	slow: 4 meas./sec (ConF-Rate = Slow) fast: >1000 meas./sec (ConF-Rate = FASt and P.dEt)
Nominal temperature:	25°C

Sensor: All sensors of the GMSD and GMXD..-series without recalibration can be connected

Connection: Mini-DIN-Socket with locking mechanism
The sensor will automatically be detected, the measurement range settings are set referring to sensor data

Logger: 2 Functions: individual value logger („Func–Stor“) and cyclic logger („Func–CYCL“)
Memory: Stor: 99 data sets
 CYCL: 10000 data sets (in max. 64 recording sequences)
Cycle time CYCL: 1...3600 seconds

Display: 2 four digit LCDs (12.4mm high and 7 mm high) for measuring values, and for min/max memories, hold function, etc. as well as additional functional arrows.

Pushbuttons: 6 membrane keys

Output: 3.5 mm audio plug, stereo

Output function: selectable as serial interface or analog output

Interface: Serial interface (3.5mm jack) can be connected to USB or RS232 interface of a PC via electrically isolated interface adapter USB3100, USB 3100 N, GRS3100 or GRS3105 (see accessories).

Analog output: 0 ... 1 Volt, freely scaleable (resolution 12 bit)

Power supply: 9V battery, type: IEC 6F22 (included in scope of supply)
as well as additional d.c. connector (diameter of internal pin 1.9 mm) for external 10.5-12V direct voltage supply.  (suitable power supply: GNG10/3000)

Power consumption: Slow measuring rate: < 1.6 mA
Fast measuring rate: < 4.5 mA
Low-Power-Logger: < 0.3 mA (for cycle time>30s, without interface communication active and no alarm horn sounding) up to 0.8 mA (at cycle time 1s)

Low battery warning: ' bAt '

Working conditions: -20 ... +50 °C, 0 ... 95 %RH (not condensing)

Storage temperature: -20 ... +70 °C

Housing: impact-resistant ABS, membrane keyboard, transparent panel, Front side IP65

Dimensions: 142 x 71 x 26 mm (L x W x D)

Weight: approx. 150 g

EMC: The device corresponds to the essential protection ratings established in the Regulations of the Council for the Approximation of Legislation for the member countries regarding electromagnetic compatibility (2004/108/EG).
Additional fault: <1%

14 Reshipment and Disposal

14.1 Reshipment



GEFAHR

All devices returned to the manufacturer have to be free of any residual of measuring media and other hazardous substances. Measuring residuals at housing or sensor may be a risk for persons or environment



Use an adequate transport package for reshipment, especially for fully functional devices. Please make sure that the device is protected in the package by enough packing materials.

14.2 Disposal instructions



Batteries must not be disposed in the regular domestic waste but at the designated collecting points.



The device must not be disposed in the unsorted municipal waste! Send the device directly to us (sufficiently stamped), if it should be disposed. We will dispose the device appropriate and environmentally sound.