



## Features:

- High luminous output
- 3mm Standard directivity
- Superior weather-resistance
- Water clear type
- Common cathode

## Applications

- Toys
- Games
- Audio

## Absolute maximum rating (Ta=25°C)

Item	Symbol	Value	Unit
DC Forward current	$I_F$	30	mA
Pulse forward current*	$I_{FP}$	100	mA
Reverse voltage	$V_R$	5	V
Power dissipation	$P_D$	120	mW
Operating temperature	$T_{opr}$	-30 to +80	°C
Storage temperature	$T_{stg}$	-30 to +100	°C
Lead soldering temperature	$T_{sol}$	260°C/5 sec	-

\* Pulse width max. 10ms. Duty ratio max. 1/10

## Electrical - Optical characteristics (Ta=25°C)

Item	Symbol	Condition	Min.	Typ.	Max.	Unit
DC Forward voltage	$V_F$ (Red)	$I_F=20mA$	1.8	2.0	2.4	V
DC Forward voltage	$V_F$ (Blue)	$I_F=20mA$	2.8	3.4	4.0	V
DC Reverse current	$I_R$	$V_R=5V$	-	-	10	$\mu A$
Domi. wavelength	$\lambda_D$ (Red)	$I_F=20mA$	620	625	630	nm
	$\lambda_D$ (Blue)	$I_F=20mA$	465	470	475	nm
Luminous intensity	$I_V$ (Red)	$I_F=20mA$	4200	5800	7000	mcd
	$I_V$ (Blue)	$I_F=20mA$	3000	4200	5800	mcd
50% Power angle	$2\theta_{1/2}$	$I_F=20mA$	-	30	-	deg

## Outline dimensions:

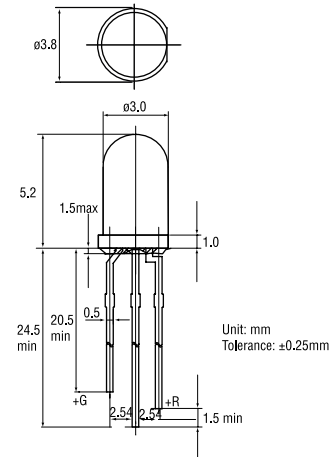

## Directivity:

