

Part Number: L-7104ID-12V

High Efficiency Red

### Features

- Low power consumption.
- Popular T-1 diameter package.
- General purpose leads.
- Reliable and rugged.
- Long life - solid state reliability.
- Available on tape and reel.
- 12V internal resistor.
- RoHS compliant.

### Description

The High Efficiency Red source color devices are made with Gallium Arsenide Phosphide on Gallium Phosphide Orange Light Emitting Diode.

### Package Dimensions



#### Notes:

1. All dimensions are in millimeters (inches).
2. Tolerance is  $\pm 0.25(0.01)$ " unless otherwise noted.
3. Lead spacing is measured where the leads emerge from the package.
4. The specifications, characteristics and technical data described in the datasheet are subject to change without prior notice.



## Selection Guide

Part No.	Dice	Lens Type	Iv (mcd) [2] V= 12V		Viewing Angle [1]
			Min.	Typ.	2θ1/2
L-7104ID-12V	High Efficiency Red (GaAsP/GaP)	Red Diffused	12	20	40°

Notes:

1. θ1/2 is the angle from optical centerline where the luminous intensity is 1/2 of the optical peak value.
2. Luminous intensity/ luminous Flux: +/-15%.

## Electrical / Optical Characteristics at TA=25°C

Symbol	Parameter	Device	Typ.	Max.	Units	Test Conditions
$\lambda_{peak}$	Peak Wavelength	High Efficiency Red	627		nm	V <sub>F</sub> =12V
$\lambda_D$ [1]	Dominant Wavelength	High Efficiency Red	625		nm	V <sub>F</sub> =12V
$\Delta\lambda_{1/2}$	Spectral Line Half-width	High Efficiency Red	45		nm	V <sub>F</sub> =12V
I <sub>F</sub>	Forward Current	High Efficiency Red	8.5	11.5	mA	V <sub>F</sub> =12V
I <sub>R</sub>	Reverse Current	High Efficiency Red		10	μA	V <sub>R</sub> = 5V

Note:

- 1.Wavelength: +/-1nm.

## Absolute Maximum Ratings at TA=25°C

Parameter	High Efficiency Red	Units
Power dissipation	120	mW
Forward Voltage	14	V
Reverse Voltage	5	V
Operating Temperature	-40°C To +70°C	
Storage Temperature	-40°C To +85°C	
Lead Solder Temperature [1]	260°C For 3 Seconds	
Lead Solder Temperature [2]	260°C For 5 Seconds	

Notes:

1. 2mm below package base.
2. 5mm below package base.

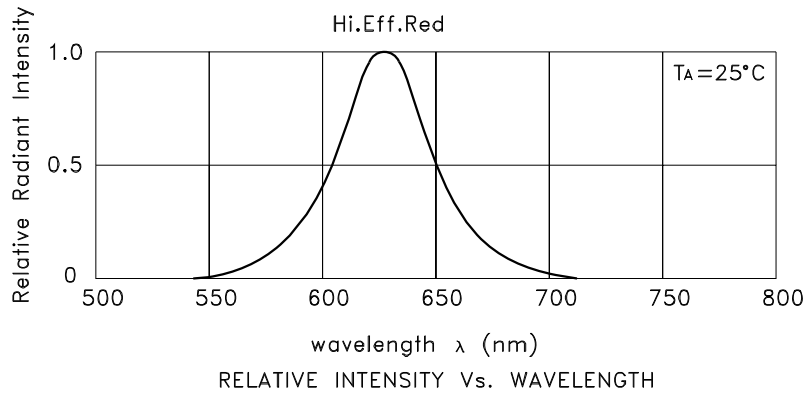

## High Efficiency Red L-7104ID-12V

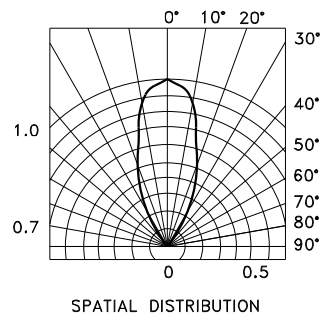
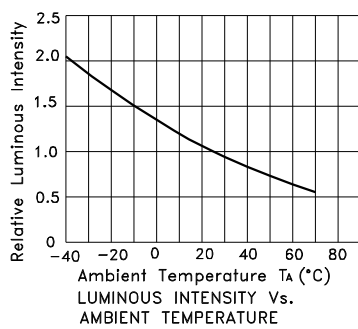
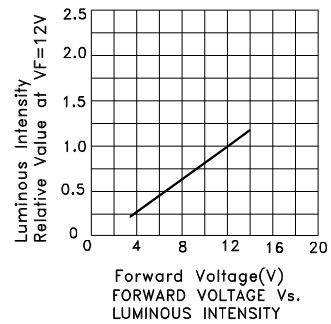
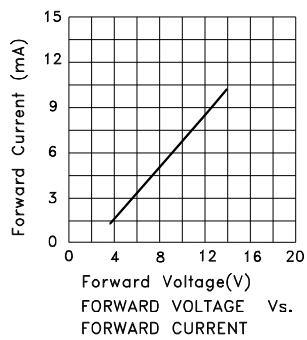

# Kingbright

## PACKING & LABEL SPECIFICATIONS

L-7104ID-12V

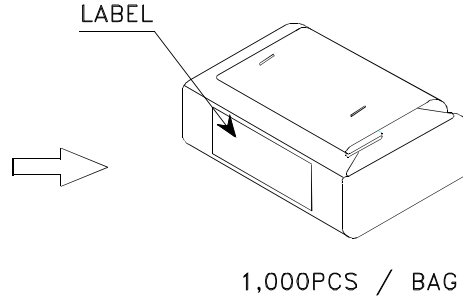
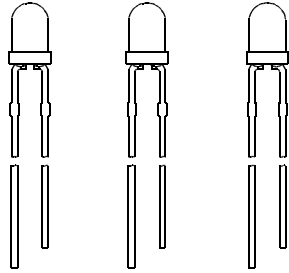

OUTSIDE LABEL

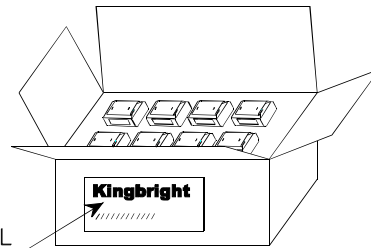
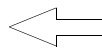

OUTSIDE LABEL

56K / 9# BOX

28K / 5# BOX

<h1>Kingbright</h1>	
P/NO: L-7104xxx	
QTY: 1000 pcs	Q.C. <span style="border: 1px solid black; border-radius: 50%; padding: 2px;">Q C XX XX XXXX PASSED</span>
S/N: XXXX	
CODE: XXX	
LOT NO:	
 xxxxxxxxxxxxxxxxxxxxxxxxxxxx	
RoHS Compliant	

## LED MOUNTING METHOD

1. The lead pitch of the LED must match the pitch of the mounting holes on the PCB during component placement. Lead-forming may be required to insure the lead pitch matches the hole pitch. Refer to the figure below for proper lead forming procedures.

(Fig. 1)

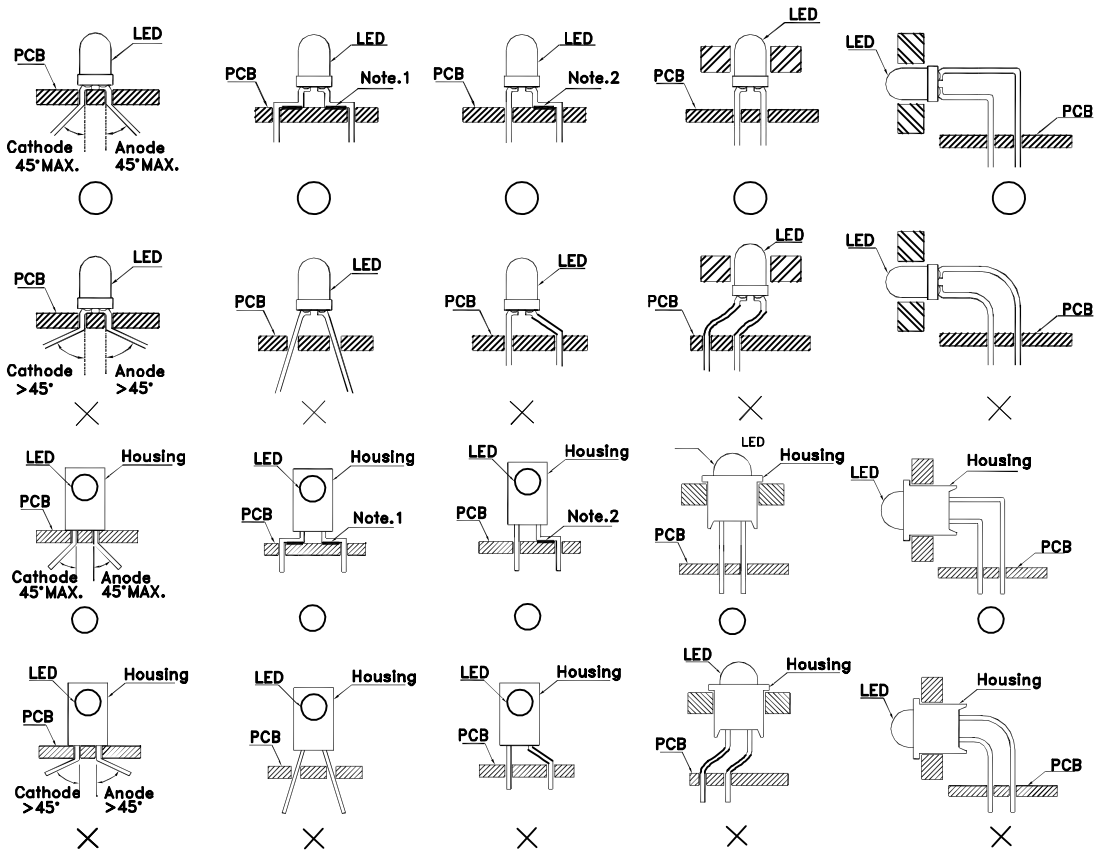

Fig.1

“O” Correct mounting method “X” Incorrect mounting method  
 Note 1-2 : Do not route PCB trace in the contact area between the leadframe and the PCB to prevent short-circuits.

2. When soldering wire to the LED, use individual heat-shrink tubing to insulate the exposed leads to prevent accidental contact short-circuit.  
 (Fig. 2)

3. Use stand-offs (Fig. 3) or spacers (Fig. 4) to securely position the LED above the PCB.

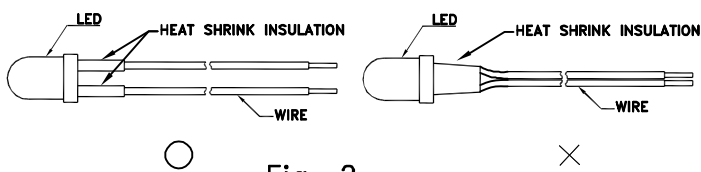

Fig. 2

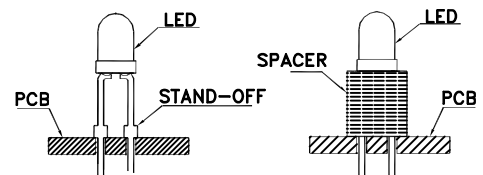

Fig. 3

Fig. 4

## LEAD FORMING PROCEDURES

1. Maintain a minimum of 2mm clearance between the base of the LED lens and the first lead bend. (Fig. 5 and 6)

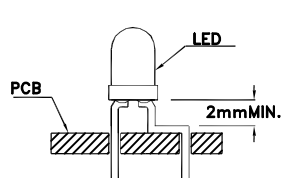

Fig. 5

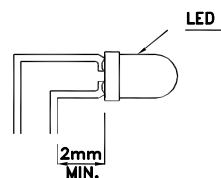

Fig. 6

2. Lead forming or bending must be performed before soldering, never during or after Soldering.
3. Do not stress the LED lens during lead-forming in order to fractures in the lens epoxy and damage the internal structures.
4. During lead forming, use tools or jigs to hold the leads securely so that the bending force will not be transmitted to the LED lens and its internal structures. Do not perform lead forming once the component has been mounted onto the PCB. (Fig. 7)
5. Do not bend the leads more than twice. (Fig. 8)
6. After soldering or other high-temperature assembly, allow the LED to cool down to 50°C before applying outside force (Fig. 9). In general, avoid placing excess force on the LED to avoid damage. For any questions please consult with Kingbright representative for proper handling procedures.

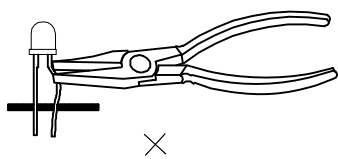

Fig. 7

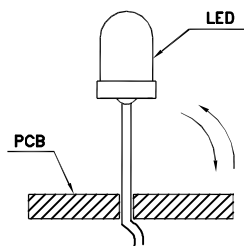

Fig. 8

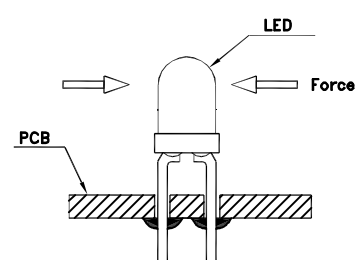

Fig. 9

7. No stress shall be applied on the LED during soldering to prevent damage.

