



eCOM pluggable PCB connector with straight solder pins; with gripping plate; 2-pole; Pin spacing 3.5 mm / 0.138 in

Item No.: 2091-1152



Marking

RoHS ✓
Compliant

Business data

Supplier	WAGO
Item no.	2091-1152
GTIN / EAN	4050821162322
Content	1

Notes

Item description: Universal connection for all conductor types Simple, push-in termination of solid and ferruled conductors Easy-to-use design does not require special tools Ability to wire while mated or unmated Integrated test ports for testing parallel to conductor entry Custom-installed solder pins Safety information 1: The picoMAX® pluggable connection system is designed without breaking capacity for compliance with DIN EN 61984. When used as intended, MCS Connectors shall not be connected/disconnected when live or under load. The circuit design should ensure header pins, which can be touched, are not live when unmated.

Technical data

--	--

Technical data	
<i>Ratings per</i>	<i>IEC/EN 60664-1</i>
<i>Rated voltage (III / 3) [V]</i>	<i>160 [V]</i>
<i>Rated impulse voltage (III / 3) [kV]</i>	<i>2.5 [kV]</i>
<i>Rated voltage (III/2) [V]</i>	<i>160 [V]</i>
<i>Rated impulse voltage (III / 2) [kV]</i>	<i>2.5 [kV]</i>
<i>Rated voltage (II / 2) [V]</i>	<i>320 [V]</i>
<i>Rated impulse voltage (II / 2) [kV]</i>	<i>2.5 [kV]</i>
<i>Rated current [A]</i>	<i>10 [A]</i>
<i>Legend (ratings)</i>	<i>(III / 2) Overvoltage category III / Pollution degree 2</i>
<i>No. of poles</i>	<i>2</i>
<i>Total number of connection points</i>	<i>2</i>
<i>Total number of potentials</i>	<i>2</i>
<i>Number of connection types</i>	<i>1</i>
<i>Number of levels</i>	<i>1</i>
<i>Connection technology</i>	<i>Push-in CAGE CLAMP®</i>
<i>Actuation type</i>	<i>Operating lever</i>
<i>Solid conductor</i>	<i>0.2 ... 1.5 mm² / 24 ... 14 AWG</i>
<i>Fine-stranded conductor</i>	<i>0.2 ... 1.5 mm² / 24 ... 14 AWG</i>
<i>Fine-stranded conductor with ferrule with plastic collar</i>	<i>0.25 ... 0.75 mm²</i>
<i>Fine-stranded conductor with ferrule without plastic collar</i>	<i>0.25 ... 1.5 mm²</i>
<i>Strip length</i>	<i>8 ... 9 mm / 0.31 ... 0.35 Inch</i>
<i>Conductor entry angle to the PCB [°]</i>	<i>90 [°]</i>
<i>Pin spacing</i>	<i>3.5 mm (0.138 in)</i>
<i>Width</i>	<i>7 mm / 0.276 Inch</i>
<i>Height</i>	<i>30 mm / 1.181 Inch</i>
<i>Depth</i>	<i>11.4 mm / 0.449 Inch</i>
<i>Solder pin length [mm]</i>	<i>3.6 [mm]</i>
<i>Solder pin diameter [mm]</i>	<i>1 [mm]</i>
<i>Drilled hole diameter (tolerance) [mm]</i>	<i>1.2(+ 0.1) [mm]</i>
<i>Contact type (pluggable connector)</i>	<i>Female connector/socket</i>
<i>Connector connection type</i>	<i>for PCBs</i>
<i>Mismating protection</i>	<i>nein</i>
<i>Mating direction to the PCB [°]</i>	<i>90 [°]</i>
<i>PCB contact</i>	<i>THT</i>

Technical data	
<i>Color</i>	<i>light gray</i>
<i>Material group</i>	<i>I</i>
<i>Insulating material</i>	<i>Polyphthalamide (PPA GF)</i>
<i>Flammability class per UL94</i>	<i>V0</i>
<i>Clamping spring material</i>	<i>Chrome nickel spring steel (CrNi)</i>
<i>Contact material</i>	<i>Electrolytic copper (Ecu)</i>
<i>Contact plating</i>	<i>tin-plated</i>
<i>Fire load [MJ]</i>	<i>0.023 [MJ]</i>
<i>Weight [g]</i>	<i>1.121 [g]</i>
<i>Limit temperature range</i>	<i>-60 ... 100 °C</i>
<i>Pin spacing from [in]</i>	<i>0.138 [in]</i>
<i>Pin spacing from [mm]</i>	<i>3.5 [mm]</i>
<i>Contact type</i>	<i>Female connector/socket; for PCBs</i>
<i>Product Family</i>	<i>picoMAX eCOM</i>
<i>Main product function</i>	<i>Female connector/socket</i>
<i>Product type</i>	<i>Pluggable PCB connectors</i>

Images & drawings



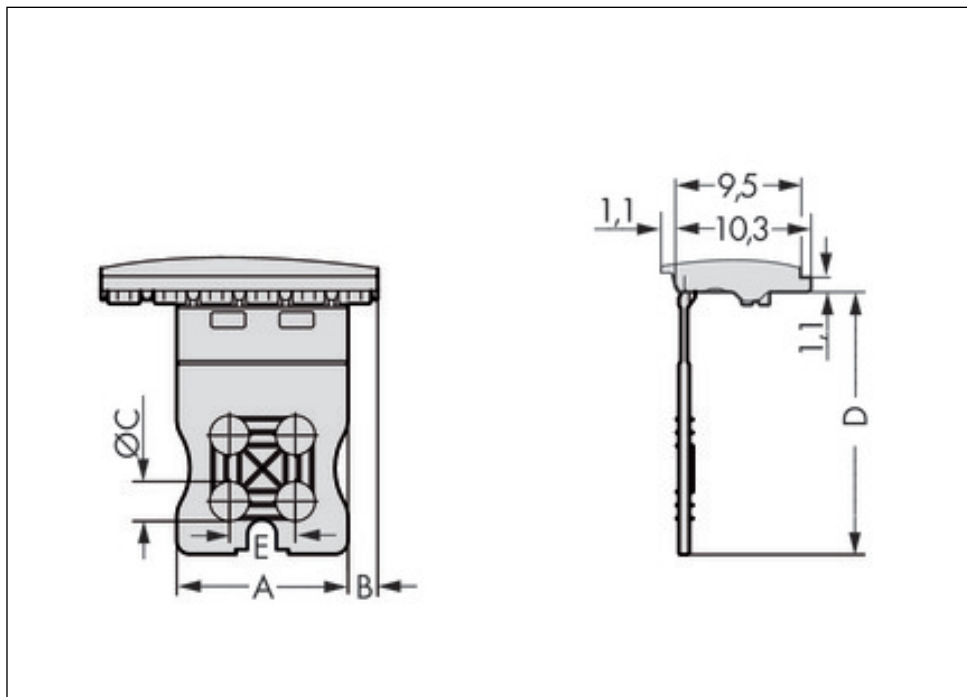
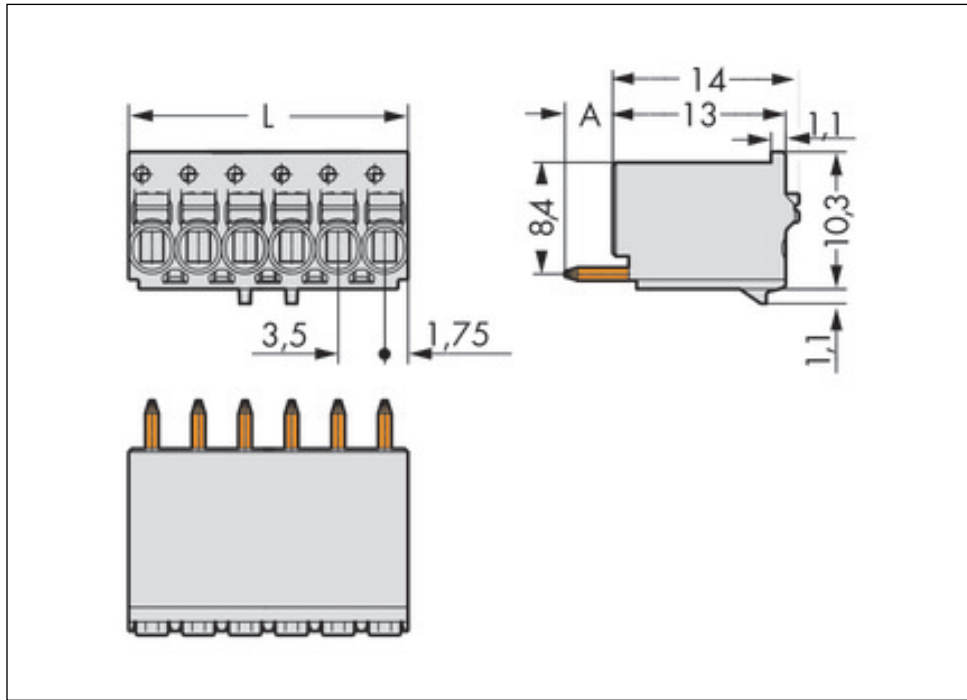

Address

WAGO Kontakttechnik GmbH & Co. KG

Hansastr. 27

32423 Minden

Telefon: 0571/887-0

Fax: 0571/887-169

<http://www.wago.com>

© WAGO Kontakttechnik GmbH & Co. KG

Technische Änderungen und Irrtümer vorbehalten.