

LED Displays

Order code	Manufacturer code	Description
57-0105	SC03-12HWA	0.3" LED DISPLAY CATHODE RED (RC)

LED Displays	Page 1 of 5
The enclosed information is believed to be correct, Information may change without notice due to product improvement. Users should ensure that the product is suitable for their use. E. & O. E.	Revision A 20/02/2007

PRELIMINARY SPEC

Part Number: SC03-12HWA

BRIGHT RED

Features

- 0.3 INCH DIGIT HEIGHT.
- LOW CURRENT OPERATION.
- EXCELLENT CHARACTER APPEARANCE.
- EASY MOUNTING ON P.C . BOARDS OR SOCKETS.
- I.C. COMPATIBLE.
- CATEGORIZED FOR LUMINOUS INTENSITY.
- MECHANICALLY RUGGED.
- STANDARD : GRAY FACE, WHITE SEGMENT.
- RoHS COMPLIANT.

Description

The Bright Red source color devices are made with Gallium Phosphide Red Light Emitting Diode.

Package Dimensions & Internal Circuit Diagram

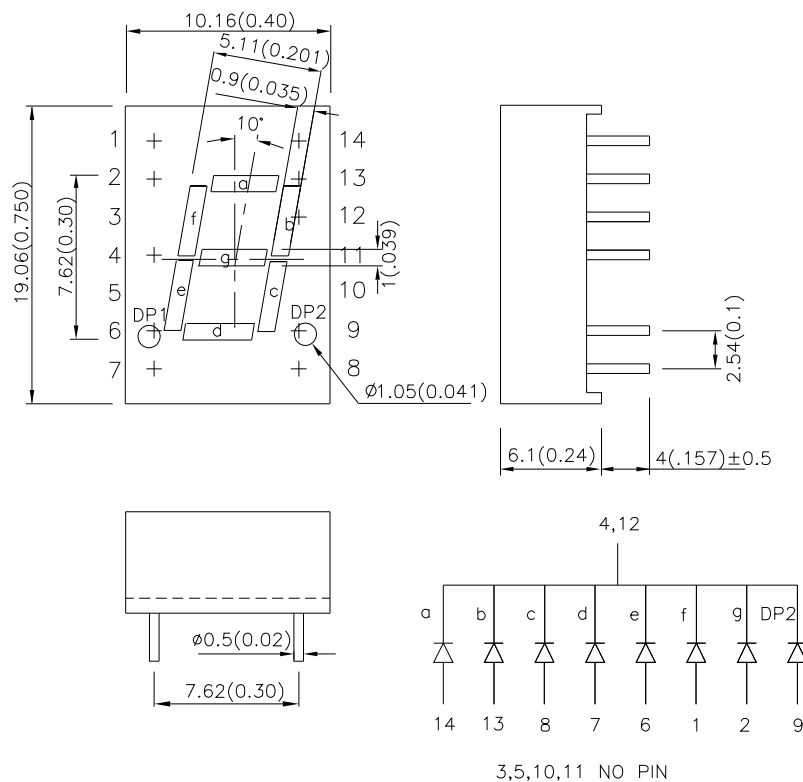

Notes:

1. All dimensions are in millimeters (inches), Tolerance is $\pm 0.25(0.01)$ unless otherwise noted.
2. Specifications are subject to change without notice.



Selection Guide

Part No.	Dice	Lens Type	Iv (ucd) [1] @ 10mA		Description
			Min.	Typ.	
SC03-12HWA	BRIGHT RED(GaP)	WHITE DIFFUSED	480	2000	Common Cathode, Rt. Hand Decimal.

Note:

1. Luminous Intensity / Luminous Flux: +/-15%

Electrical / Optical Characteristics at TA=25°C

Symbol	Parameter	Device	Typ.	Max.	Units	Test Conditions
λ_{peak}	Peak Wavelength	Bright Red	700		nm	IF=20mA
λ_D [1]	Dominant Wavelength	Bright Red	660		nm	IF=20mA
$\Delta\lambda_{1/2}$	Spectral Line Half-width	Bright Red	45		nm	IF=20mA
C	Capacitance	Bright Red	40		pF	VF=0V;f=1MHz
VF [2]	Forward Voltage	Bright Red	2.25	2.5	V	IF=20mA
IR	Reverse Current	Bright Red		10	uA	VR = 5V

Notes:

1.Wavelength: +/-1nm

2.Forward Voltage: +/-0.1V

Absolute Maximum Ratings at TA=25°C

Parameter	Bright Red	Units
Power dissipation	62.5	mW
DC Forward Current	25	mA
Peak Forward Current [1]	130	mA
Reverse Voltage	5	V
Operating / Storage Temperature	-40°C To +85°C	
Lead Solder Temperature [2]	260°C For 3 Seconds	

Notes:

1. 1/10 Duty Cycle, 0.1ms Pulse Width.

2. 2mm below package base.

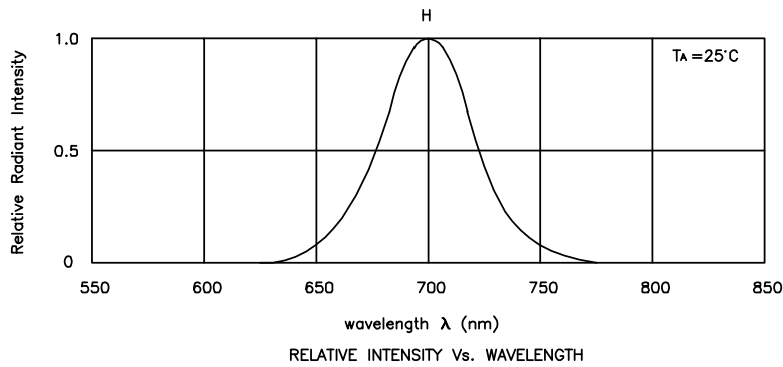

Bright Red

SC03-12HWA

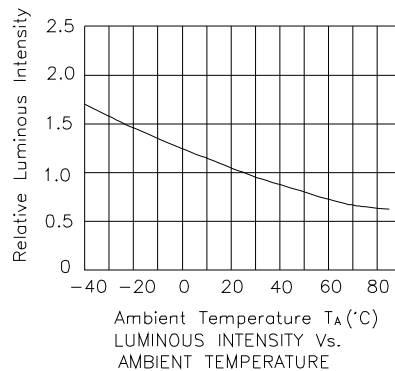
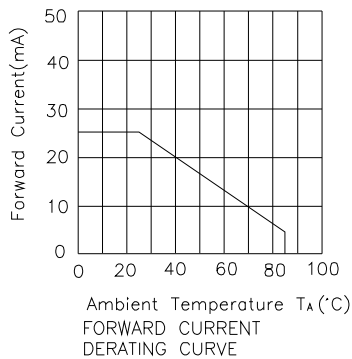
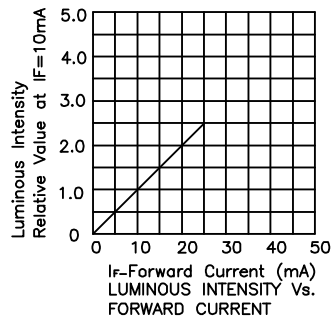
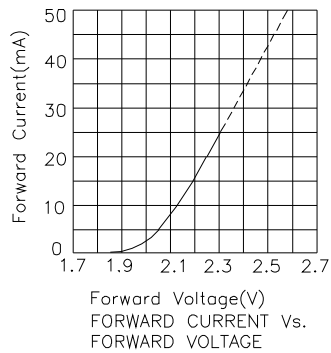

PACKING & LABEL SPECIFICATIONS

SC03-12HWA

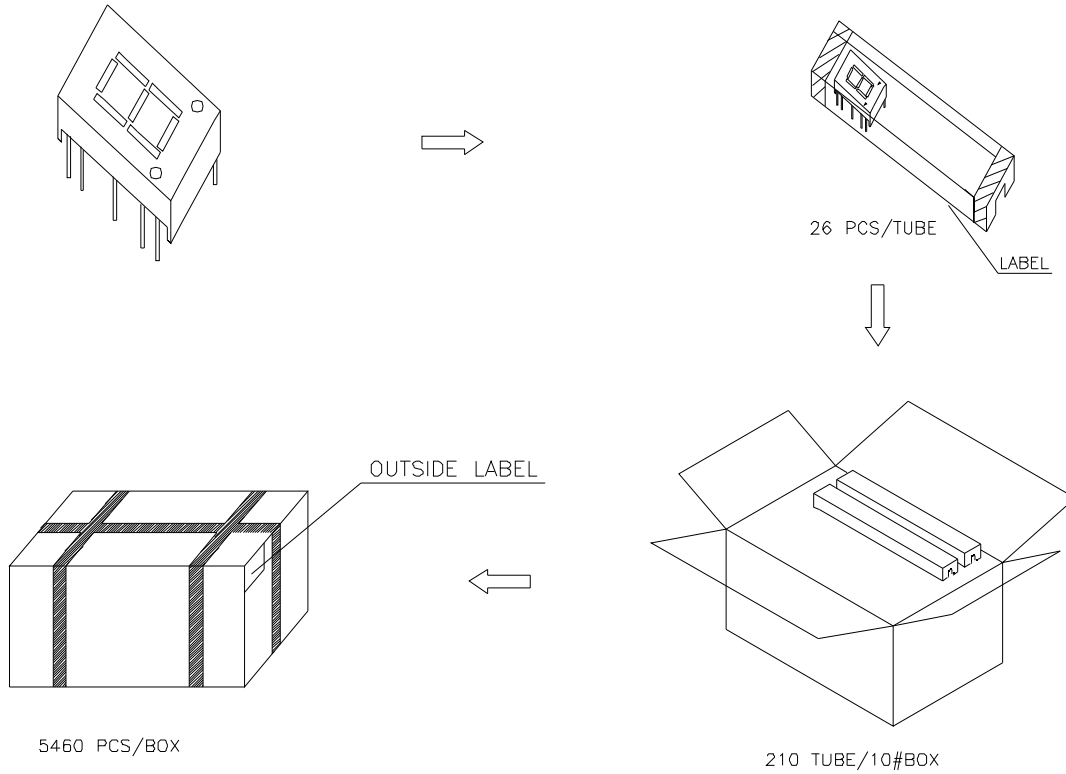

Inside LABEL Paste On The IC-tube

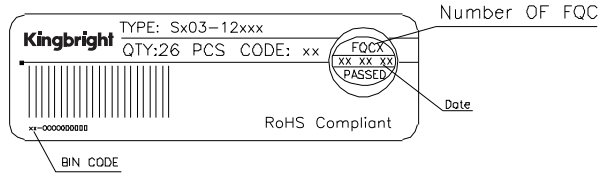

Outside LABEL Paste On The Box

