



Female connector with gripping plate; 2-pole; Pin spacing 5 mm / 0.197 in

Item No.: 2092-1102



Marking

RoHS ✓
Compliant

Business data

Supplier	WAGO
Item no.	2092-1102
GTIN / EAN	4050821163398
Content	1

Notes

Item description: Universal connection for all conductor types Simple, push-in termination of solid and ferruled conductors Easy-to-use design does not require specialty tools Ability to wire while mated or unmated Test port parallel to conductor entry – touch contact Integrated locking latches prevent accidental disconnection Safety information 1: The picoMAX® pluggable connection system is designed without breaking capacity for compliance with DIN EN 61984. When used as intended, MCS Connectors shall not be connected/disconnected when live or under load. The circuit design should ensure header pins, which can be touched, are not live when unmated.

Technical data

Miscellaneous

Ratings per	IEC/EN 60664-1

Technical data	
Rated voltage (III / 3) [V]	250 [V]
Rated impulse voltage (III / 3) [kV]	4 [kV]
Rated voltage (III/2) [V]	320 [V]
Rated impulse voltage (III / 2) [kV]	4 [kV]
Rated voltage (II / 2) [V]	630 [V]
Rated impulse voltage (II / 2) [kV]	4 [kV]
Rated current [A]	16 [A]
Legend (ratings)	(III / 2) Overvoltage category III / Pollution degree 2
No. of poles	2
Total number of connection points	2
Total number of potentials	2
Number of connection types	1
Number of levels	1
Connection technology	Push-in CAGE CLAMP®
Actuation type	Operating lever
Solid conductor	0.2 ... 2.5 mm ² / 24 ... 12 AWG
Fine-stranded conductor	0.2 ... 2.5 mm ² / 24 ... 12 AWG
Fine-stranded conductor with ferrule with plastic collar	0.25 ... 1.5 mm ²
Fine-stranded conductor with ferrule without plastic collar	0.25 ... 2.5 mm ²
Strip length	9 ... 10 mm / 0.35 ... 0.39 Inch
Pin spacing	5 mm (0.197 in)
Width	10 mm / 0.394 Inch
Height	35.4 mm / 1.394 Inch
Depth	13.4 mm / 0.528 Inch
Contact type (pluggable connector)	Female connector/socket
Connector connection type	for conductors
Mismating protection	nein
Color	light gray
Material group	I
Insulating material	Polyphthalamide (PPA GF)
Flammability class per UL94	V0
Clamping spring material	Chrome nickel spring steel (CrNi)
Contact material	Electrolytic copper (Ecu)
Contact plating	tin-plated
Fire load [MJ]	0.048 [MJ]

Technical data	
<i>Weight [g]</i>	<i>1.989 [g]</i>
<i>Limit temperature range</i>	<i>-60 ... 100 °C</i>
<i>Pin spacing from [in]</i>	<i>0.197 [in]</i>
<i>Pin spacing from [mm]</i>	<i>5 [mm]</i>
<i>Contact type</i>	<i>Female connector/socket; for conductors</i>
<i>Product Family</i>	<i>picoMAX®</i>
<i>Main product function</i>	<i>Female connector/socket</i>
<i>Product type</i>	<i>Pluggable PCB connectors</i>

Images & drawings

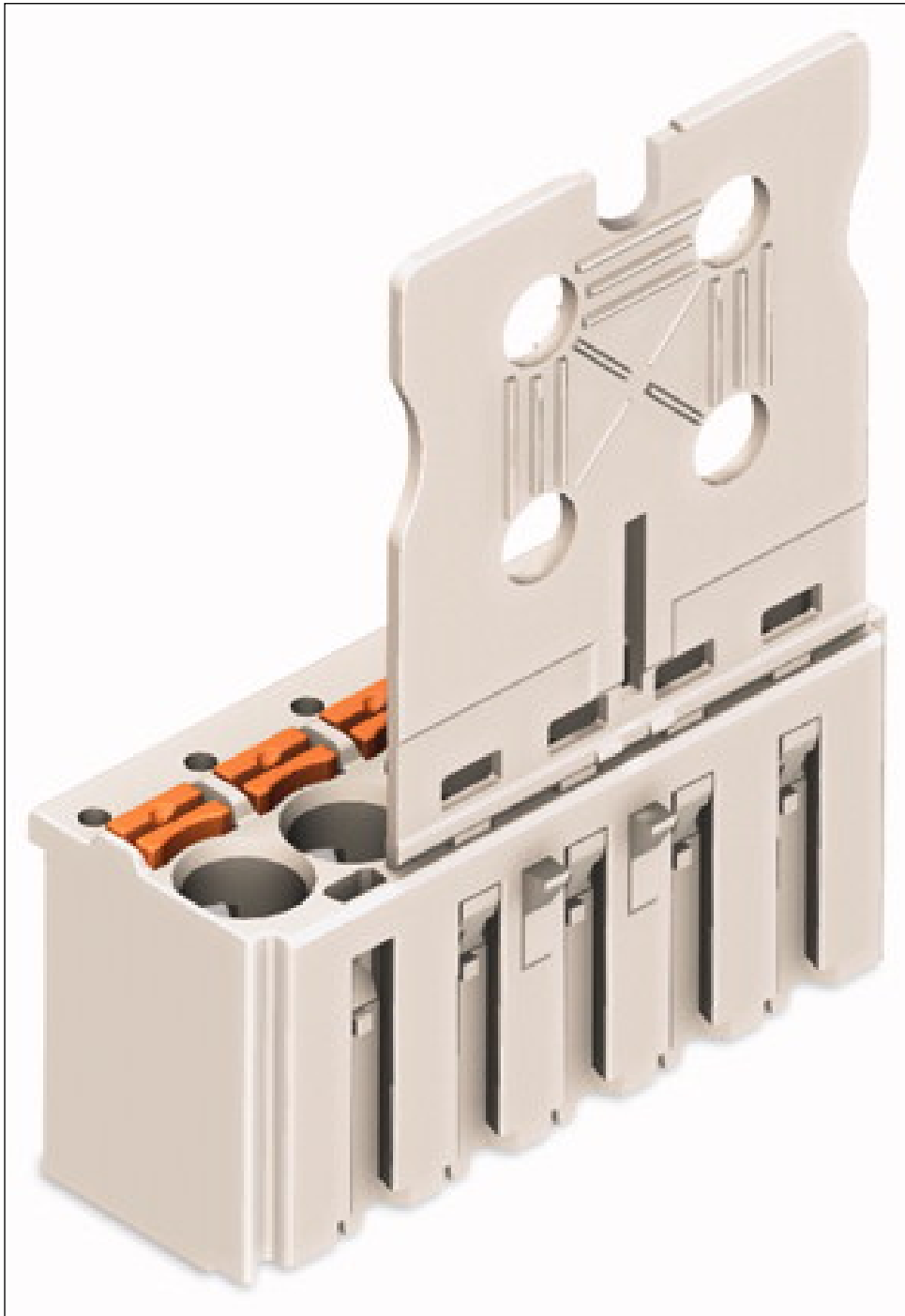

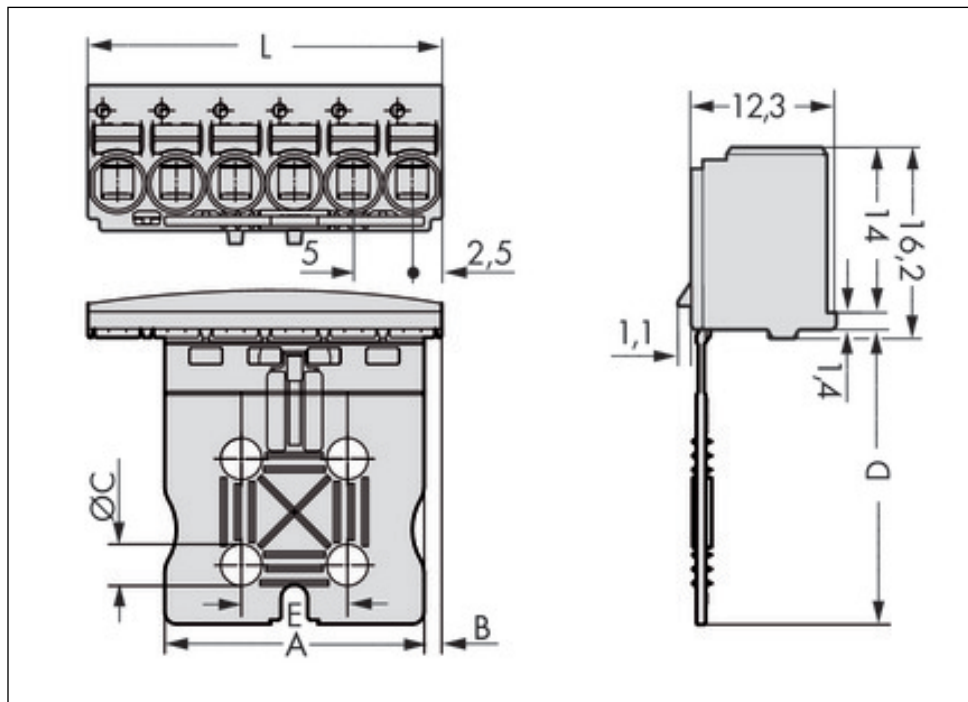

Address

WAGO Kontakttechnik GmbH & Co. KG

Hansastr. 27

32423 Minden

Telefon: 0571/887-0

Fax: 0571/887-169

<http://www.wago.com>

© WAGO Kontakttechnik GmbH & Co. KG

Technische Änderungen und Irrtümer vorbehalten.