



Male header with straight solder pins; 4-pole; Pin spacing 5 mm / 0.197 in

Item No.: 2092-1404



Marking

RoHS ✓
Compliant

Business data

Supplier	WAGO
Item no.	2092-1404
GTIN / EAN	4050821163855
Content	1

Notes

Item description: Assembly of female connectors without loss of poles, allowing different functions to be divided within one male header Coding pins inserted into the header interface prevent mismatching, allowing subsequent coding in panel feedthrough applications The female connector is fully shrouded by the male header's housing, providing vibration resistance up to 20 g Safety information 1: The picoMAX® pluggable connection system is designed without breaking capacity for compliance with DIN EN 61984. When used as intended, MCS Connectors shall not be connected/disconnected when live or under load. The circuit design should ensure header pins, which can be touched, are not live when unmated.

Technical data

--	--

Technical data	
<i>Ratings per</i>	<i>IEC/EN 60664-1</i>
<i>Rated voltage (III / 3) [V]</i>	<i>250 [V]</i>
<i>Rated impulse voltage (III / 3) [kV]</i>	<i>4 [kV]</i>
<i>Rated voltage (III/2) [V]</i>	<i>320 [V]</i>
<i>Rated impulse voltage (III / 2) [kV]</i>	<i>4 [kV]</i>
<i>Rated voltage (II / 2) [V]</i>	<i>630 [V]</i>
<i>Rated impulse voltage (II / 2) [kV]</i>	<i>4 [kV]</i>
<i>Rated current [A]</i>	<i>16 [A]</i>
<i>Legend (ratings)</i>	<i>(III / 2) Overvoltage category III / Pollution degree 2</i>
<i>No. of poles</i>	<i>4</i>
<i>Number of levels</i>	<i>1</i>
<i>Pin spacing</i>	<i>5 mm (0.197 in)</i>
<i>Width</i>	<i>22.2 mm / 0.874 Inch</i>
<i>Height</i>	<i>23.1 mm / 0.909 Inch</i>
<i>Height from the surface</i>	<i>19.5 mm / 0.768 Inch</i>
<i>Depth</i>	<i>14.4 mm / 0.567 Inch</i>
<i>Solder pin length [mm]</i>	<i>3.6 [mm]</i>
<i>Solder pin diameter [mm]</i>	<i>1.4 [mm]</i>
<i>Drilled hole diameter (tolerance) [mm]</i>	<i>1.6(+ 0.1) [mm]</i>
<i>Contact type (pluggable connector)</i>	<i>Male connector/plug</i>
<i>Connector connection type</i>	<i>for PCBs</i>
<i>Mismating protection</i>	<i>nein</i>
<i>Mating direction to the PCB [°]</i>	<i>90 [°]</i>
<i>Locking of plug-in connection</i>	<i>Male locking latch</i>
<i>PCB contact</i>	<i>THT</i>
<i>Color</i>	<i>light gray</i>
<i>Material group</i>	<i>I</i>
<i>Insulating material</i>	<i>Polyphthalamide (PPA GF)</i>
<i>Flammability class per UL94</i>	<i>V0</i>
<i>Contact material</i>	<i>Electrolytic copper (Ecu)</i>
<i>Contact plating</i>	<i>tin-plated</i>
<i>Fire load [MJ]</i>	<i>0.054 [MJ]</i>
<i>Weight [g]</i>	<i>2.63 [g]</i>
<i>Limit temperature range</i>	<i>-60 ... 100 °C</i>
<i>Pin spacing from [in]</i>	<i>0.197 [in]</i>

Technical data	
<i>Pin spacing from [mm]</i>	<i>5 [mm]</i>
<i>Contact type</i>	<i>Male connector/plug; for PCBs</i>
<i>Product Family</i>	<i>picoMAX®</i>
<i>Main product function</i>	<i>Male connector/plug</i>
<i>Product type</i>	<i>Pluggable PCB connectors</i>

Images & drawings



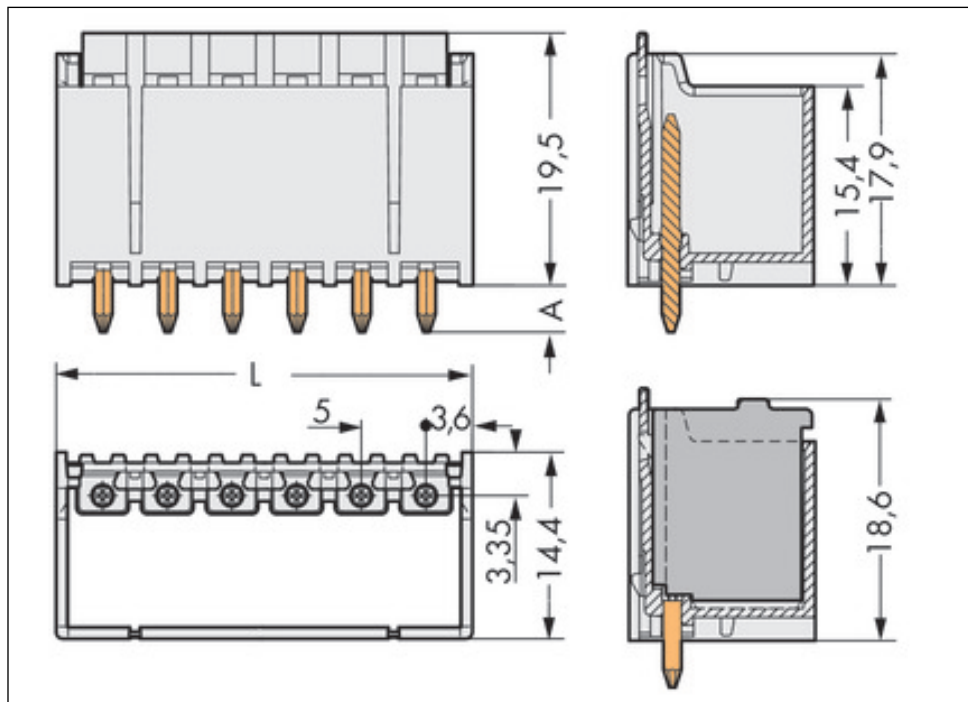

Address

WAGO Kontakttechnik GmbH & Co. KG

Hansastr. 27

32423 Minden

Telefon: 0571/887-0

Fax: 0571/887-169

<http://www.wago.com>

© WAGO Kontakttechnik GmbH & Co. KG

Technische Änderungen und Irrtümer vorbehalten.