

Data sheet | Item number: 2002-1441

Double potential terminal block; 2.5 mm²; with double, center marker slot; for DIN-rail 35 x 15 and 35 x 7.5; Push-in CAGE CLAMP®

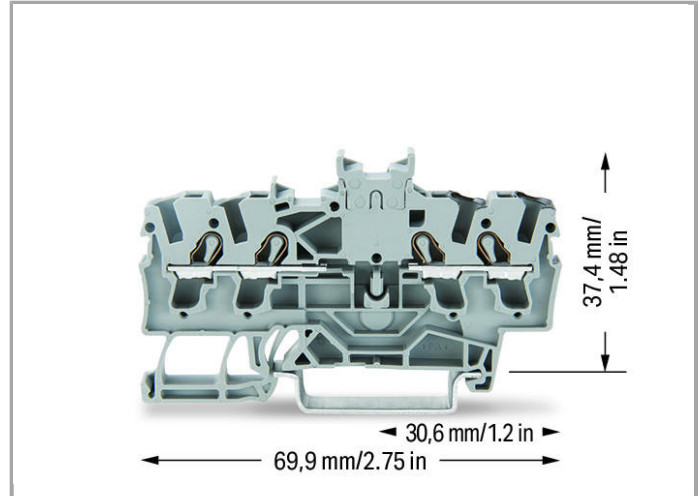

www.wago.com/2002-1441

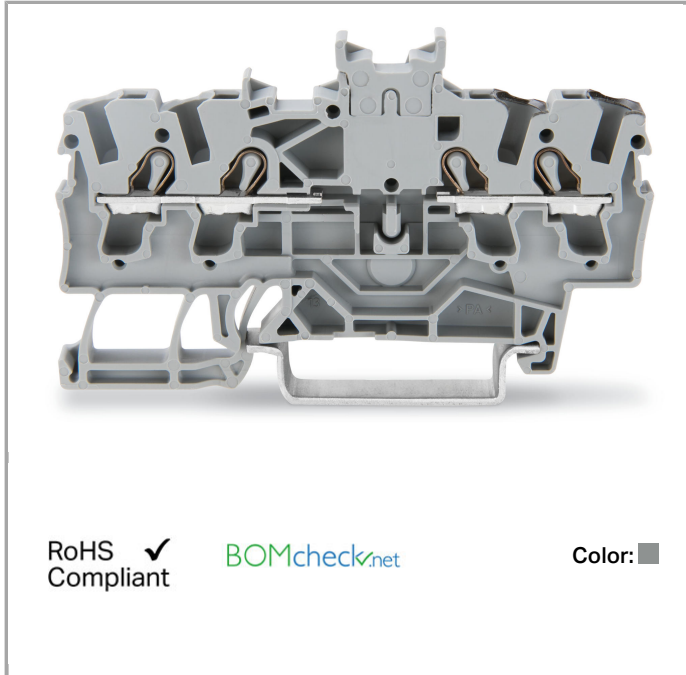

RoHS Compliant

[BOMcheck.net](https://www.bomcheck.net)

Color: ■

Data

Electrical data

Ratings per IEC/EN 60664-1

Rated voltage (III / 3)	800 V
Rated impulse voltage (III / 3)	8 kV
Rated current	24 A
Rated current (2)	32 A
Legend (ratings)	(III / 3) ≙ Overvoltage category III / Pollution degree 3

Approvals per UL 1059

Rated voltage UL (Use Group B)	600 V
Rated current UL (Use Group B)	20 A
Rated voltage UL (Use Group C)	600 V
Rated current UL (Use Group C)	20 A

Approvals per CSA

Rated voltage CSA (Use Group B)	600 V
Rated current CSA (Use Group B)	20 A



Rated voltage CSA (Use Group C)	600 V
Rated current CSA (Use Group C)	20 A

Connection data

Connection technology	Push-in CAGE CLAMP®
Number of connection points (connection type)	2
Actuation type	Push-in Open Tool Slot
Connectable conductor materials	Copper
Nominal cross section	2.5 mm ²
Solid conductor	0.25 ... 4 mm ² / 22 ... 12 AWG
Solid conductor, push-in termination	0.75 ... 4 mm ² / 18 ... 12 AWG
Fine-stranded conductor	0.25 ... 4 mm ² / 22 ... 12 AWG
Fine-stranded conductor with ferrule, push-in termination, from	0.75 mm ² / 18 AWG
Strip length	10 ... 12 mm / 0.39 ... 0.47 Inch
Number of connection points	2
Total number of connection points	4
Total number of potentials	1
Number of levels	1
Type of wiring	Front-entry wiring

Geometrical Data

Width	5.2 mm / 0.205 inch
Height from upper-edge of DIN-35 rail	32.9 mm / 1.295 inch
Depth	69.9 mm / 2.752 inch

Mechanical data

Design	horizontal
Type of mounting	DIN-35 rail
Marking level	Center/side marking

Material Data

Color	gray
Insulating material	Polyamide 66 (PA 66)
Fire load	0.165 MJ
Weight	7.807 g

Approvals / Certificates

Ex-Approvals

Logo	Approval	Certificate name

AEx
 AEx
 UL International Germany GmbH c/o Physikalisch Technische
 Bundesanstalt

E185892 sec.7



ATEX
 Physikalisch Technische Bundesanstalt (PTB)





PTB 03 ATEX 1162 U (II 2 G/D Ex e II bzw. I M 2 Ex e I)





IECEX
 Physikalisch Technische Bundesanstalt

IECEX PTB 03.0004U

Country specific Approvals

Logo	Approval	Certificate name
	CCA DEKRA Certification B.V.	NTR NL 7585
	CSA DEKRA Certification B.V.	1536069
	CSA DEKRA Certification B.V.	1536069
	KEMA/KEUR DEKRA Certification B.V.	2198985.01
	KEMA/KEUR DEKRA Certification B.V.	2198985.01

Ship Approvals

Logo	Approval	Certificate name
	ABS American Bureau of Shipping	14-HG1293677-PDA
	BV Bureau Veritas S.A.	38586/A0 BV
	DNV GL Det Norske Veritas, Germanischer Lloyd	TAE00001V2



LR
Lloyds Register

91/20112 (E9)

UL-Approvals

Logo

Approval

Certificate name



cURus
Underwriters Laboratories Inc.

E45172



UR
DEKRA Certification B.V.

NTR NL 7704

Subject to changes.