

Pneufit D offers a broad range of over 600 plastic fittings to compliment the popular Pneufit C, Pneufit M and Pneufit Metal ranges.

Pneufit D fittings are manufactured from FDA approved acetal material, and are certified by NSF (51 & 61), WRAS and SKZert for use with water and food.

Norgren Pneufit® D fittings are ready to use, offering fast assembly with no need for tools providing optimum flow.

Releasable stainless-steel grab-ring to grip nylon or polyurethane tube (85 or 95 durometer).

Appropriate for inert gas and industrial air applications.

Suited for use in medical and analytical equipment for fluid and gas control.



Technical data

Medium:

Air and liquids

Operating pressure:

749,3 mmHg vacuum up to:

4 mm to 8 mm, -20°C to +20°C ; 15 bar

10 mm to 12 mm, -20°C to +20°C ; 12 bar

4 mm to 8 mm, +20°C to +65°C ; 10 bar

10 mm to 12 mm, +20°C to +65°C ; 7 bar

Temperature:

-20°C to 65°C

Tube Sizes:

4, 5, 6, 8, 10, 12 mm

Thread Sizes:

1/8, 1/4, 3/8, 1/2 inch

BSPT, BSPP, UNF and UNS types

Tube Types:

Nylon, Polyurethane, Polyethylene

Materials

Body: Acetal

Seals: NBR

Release Sleeve: Acetal

Grab Ring: Stainless Steel

Ordering Examples

Information 2

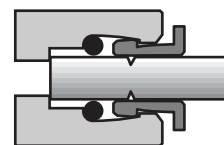



Method of assembly



1. Ensure that the end of the tube is cut square and is free from burrs.

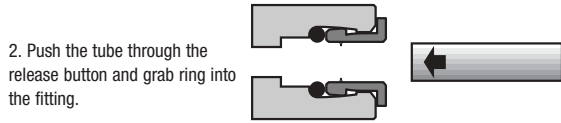

2. Push the tube through the release button and grab ring into the fitting.

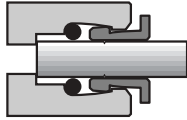

3. Push the tube firmly through the 'O' ring until it bottoms on the tube stop then pull back.

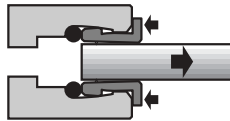

4. To disconnect, push the tube into the fitting, hold down the release button and withdraw the tube.

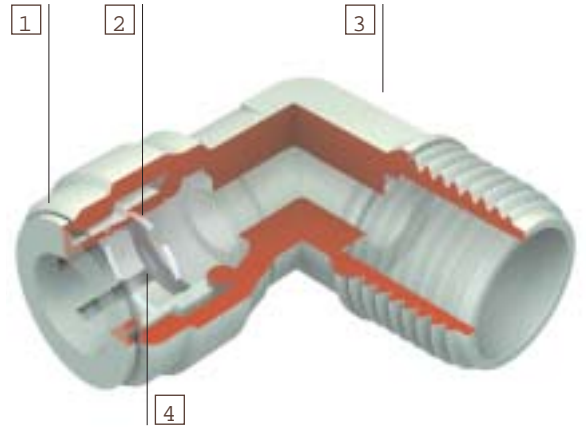

- 1 Collet- unique oval shape allowing for easier connecting and disconnecting.
- 2 Oring- NBR provides leak proof seal.
- 3 Body and Cap- made of highly durable acetal copolymer (POM).
- 4 Grab Ring- stainless steel teeth holds tubing in place.

Options selector



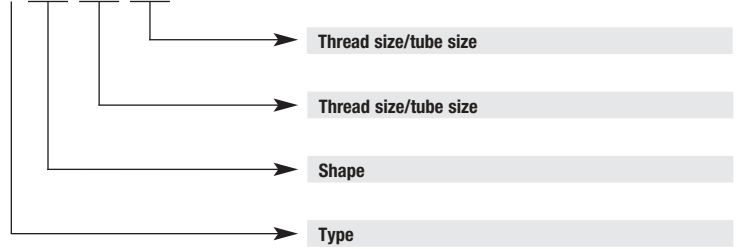











D0★★★★★





Pneufit D

Straight adaptors and connectors

Straight union D0020  Page 4	Straight adaptor D0125  Page 4	Straight adaptor D0225  Page 4	Straight adaptor (female) D042B  Page 4	Straight adaptor (female thread) D012C  Page 4	Female adaptor D042D  Page 5	Stem tail piece adaptor D0039  Page 5
Female adaptor D022C D022D  Page 5	Bulkhead union D0029  Page 5	Stem reducer D0023  Page 5	Plug D0004  Page 10	End stop (female plug) D000A  Page 10	Stem adaptor (stem/tube) D0115  Page 6	Stem adaptor D0215  Page 6

Elbow connectors and adaptors

Union elbow D0040  Page 6	Ebow adaptor D0145  Page 6	90° Swivel elbow adaptor D0147  Page 6	90° Swivel elbow adaptor D0247  Page 7	45° Elbow adaptor D005A  Page 7	Stem elbow D0043  Page 7
--	---	---	---	---	---











Tee connectors and adaptors

Union tee D0060  Page 7	Union tee (reducing) D006A  Page 7	Union tee (reducing) D006B  Page 7	Swivel tee adaptor D0167  Page 7	Swivel side tee adaptor D0168  Page 8	Swivel tee adaptor D0267  Page 8	Swivel side tee adaptor D0268  Page 8
--	---	---	---	---	---	--

Y Connectors

Union Y D0082  Page 8	U bend D0089  Page 9	Union cross D0090  Page 9	3 way splitter D0091  Page 9
--	---	--	---

Accessories

Check valve D00GL  Page 9	Shut-off valve mounting clip D00GM  Page 10	Hand valve 2/2 Shut-off D00GR  Page 9	Hand valve 2/2 Shut-off D01GT  Page 9	Hand valve 2/2 Shut-off D01GU  Page 9
Tube supports D0033  Page 10	Tube supports D0033****H  Page 10	Flow bend tube clip D005B  Page 10	Locking clip D00LC  Page 11	Cartridges D0008  Page 11



D0020

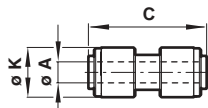

Straight union

ø A	C	ø K	Model
4	34,5	13,0	D00200400
5	34,5	13,0	D00200500
6	35,5	15,0	D00200600
8	41,0	17,5	D00200800
10	41,5	20,0	D00201000
12	50,0	23,0	D00201200

D0020

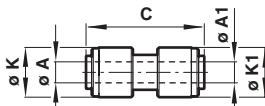

Straight union

(unequal)

ø A	ø A1	C	ø K	ø K1	Model
6	4	34,5	15,0	15,0	D00200604
6	5	35,5	15,0	15,0	D00200605
8	4	42,0	17,5	13,0	D00200804
8	5	42,0	17,5	13,0	D00200805
8	6	41,0	17,5	17,5	D00200806
10	4	37,5	20,0	13,0	D00201004
10	5	37,5	20,0	13,0	D00201005
10	6	41,0	20,0	20,0	D00201006
10	8	41,5	20,0	20,0	D00201008
12	8	49,0	23,0	23,0	D00201208
12	10	49,5	23,0	23,0	D00201210

D0125

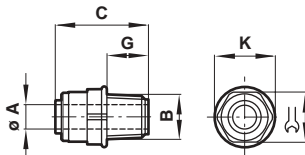

Straight adaptor

(taper)

ø A	B	C	G	ø K	Model
4	R1/8	23,5	9,5	14,0	D01250418
4	R1/4	28,5	13,5	13,0	D01250428
5	R1/8	23,5	9,5	13,0	D01250518
5	R1/4	28,5	13,5	13,0	D01250528
6	R1/8	26,0	9,5	15,0	D01250618
6	R1/4	28,0	13,5	15,0	D01250628
6	R3/8	25,5	13,5	15,0	D01250638
6	R1/2	33,0	17,5	20,0	D01250648
8	R1/8	26,5	9,5	17,5	D01250818
8	R1/4	26,5	13,5	17,5	D01250828
8	R3/8	28,5	13,5	17,5	D01250838
10	R1/8	31,0	9,5	20,0	D01251018
10	R1/4	31,0	13,5	20,0	D01251028
10	R3/8	33,0	13,5	20,0	D01251038
10	R1/2	36,5	17,5	20,0	D01251048
12	R3/8	34,5	14,0	23,0	D01251238
12	R1/2	34,5	17,5	23,0	D01251248

D0225

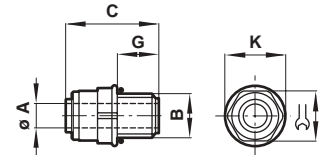

Straight adaptor

(parallel)

ø A	B	C	G	ø K	Model
4	G1/8	23,5	6,5	14,0	D02250418
4	G1/4	28,5	10,0	16,5	D02250428
5	G1/8	25,0	6,5	17,0	D02250518
5	G1/4	29,0	10,0	20,5	D02250528
6	G1/8	26,0	6,5	17,0	D02250618
6	G1/4	28,0	8,0	16,5	D02250628
8	G1/8	26,5	6,5	20,0	D02250818
8	G1/4	26,5	8,0	20,0	D02250828
8	G3/8	28,5	10,0	20,0	D02250838
10	G1/4	33,5	10,0	20,0	D02251028
10	G3/8	29,0	10,0	24,5	D02251038
10	G1/2	33,5	13,5	24,5	D02251048
12	G3/8	34,5	13,5	24,5	D02251238
12	G1/2	34,5	13,5	24,5	D02251248

D042B ... Y

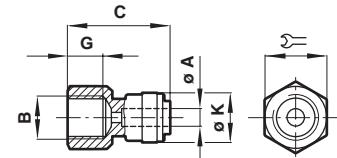

Female adaptor

(UNF-V type)

ø A	B	C	G	ø K	Model
6	7/16-20	31,0	11,5	15,0	D042B062Y
8	7/16-20	33,0	11,5	17,5	D042B082Y
10	7/16-20	35,5	11,5	20,0	D042B102Y
10	5/8-18	35,5	14,0	20,0	D042B104Y

D042B ... Z

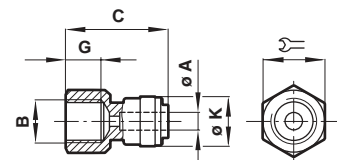

Female adaptor

(UNF)

ø A	ø B	C	ø K	G	Model
8	1/2-16	35,5	20,0	19,0	D042B083Z
10	1/2-16	35,5	20,0	19,0	D042B103Z
12	1/2-16	35,5	23,0	25,5	D042B123Z

D012C

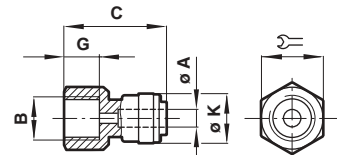

Female adaptor

(taper)

ø A	ø B	C	G	ø K	Model
6	G1/8	31,0	11,5	15,0	D012C0618
6	G1/4	31,0	11,5	15,0	D012C0628
8	G1/8	33,0	11,5	17,5	D012C0818
8	G1/4	33,0	11,5	17,5	D012C0828
10	G1/8	35,5	11,5	20,0	D012C1018
10	G1/4	35,5	11,5	20,0	D012C1028



D042D ... W

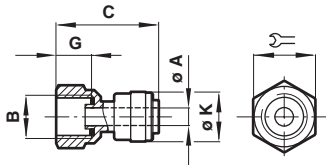

Female adaptor

(UNS cone type)

ø A	B	C	G	ø K	⌀	Model
6	7/16-24	31	6,5	15	3/4	D042D062W
8	7/16-24	33	6,5	17,5	3/4	D042D082W
10	7/16-24	35,5	6,5	20	3/4	D042D102W

D042D ... Y

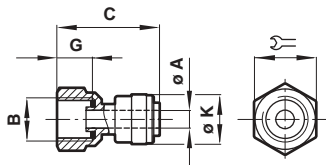

Female adaptor

(UNF cone type)

ø A	B	C	G	ø K	⌀	Model
6	7/16-20	31	11	15	3/4	D042D062Y
8	7/16-20	33	11	17,5	3/4	D042D082Y
10	7/16-20	35,5	11	20	3/4	D042D102Y

D0039

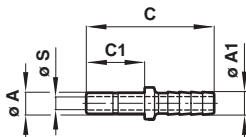

Stem tail piece adaptor

ø A	ø A1	C	C1	ø S	Model
6	4,5	38,5	17,5	1,9	D00390604
8	6,5	39,5	18,5	3,9	D00390806
10	8,5	43,5	22,0	4,9	D00391008
12	10,0	46,0	25,0	6,8	D00391210

D022C

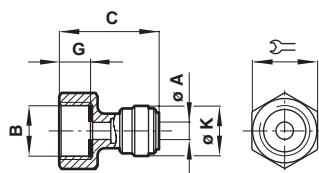

Female adaptor

(flat type)

ø A	B	C	G	ø K	⌀	Model
8	G5/8	41,5	13,5	20,0	1 1/4	D022C0858
10	G1/2	41,0	10,5	20,0	1	D022C1048
10	G5/8	41,5	13,5	20,0	1 1/4	D022C1058
12	G3/8	41,5	10,5	23,0	1	D022C1238
12	G1/2	41,5	10,5	23,0	1	D022C1248

D022D

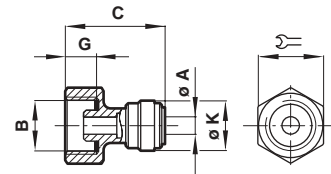

Female adaptor

(cone type)

ø A	B	C	G	ø K	⌀	Model
6	G3/8	35,5	10,5	15,0	7/8	D022D0638
6	G1/2	36,0	10,5	15,0	1	D022D0648
8	G3/8	38,5	10,5	17,5	7/8	D022D0838
8	G1/2	38,5	10,5	17,5	1	D022D0848
10	G3/8	40,0	10,5	20,0	7/8	D022D1038
10	G1/2	41,0	10,5	20,0	1	D022D1048
10	G5/8	41,5	13,5	20,0	1 1/4	D022D1058
12	G5/8	41,5	13,5	23,0	1 1/4	D022D1258

D0029

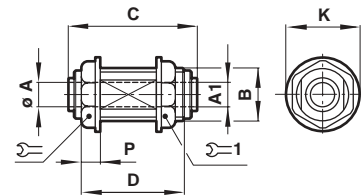

Bulkhead union

ø A	ø A1	B	C	D	ø K	P	⌀	⌀ 1	⌀ 2	Model
4	4	M16 x 1	33,0	30,5	22,5	5,5	3/4	13/16	14,5	D00290400
5	5	M16 x 1	34,5	31,5	22,5	5,5	3/4	13/16	14,5	D00290500
6	6	M16 x 1	35,0	32,0	22,5	5,5	3/4	13/16	14,5	D00290600
6	10	M20 x 1,540,0	36,5	26,5	6,5	7/8	1	19,5	19,5	D00290610
8	8	M20 x 1,540,0	37,0	26,5	6,5	7/8	1	19,5	19,5	D00290808
10	6	M20 x 1,539,5	37,0	26,5	6,5	7/8	1	19,5	19,5	D00291006
10	10	M20 x 1,540,5	37,5	26,5	6,5	7/8	1	19,5	19,5	D00291000
12	12	M27 x 1,549,5	45,0	14,0	8,0	11/8	15/16	14,5	14,5	D00291200

D0023

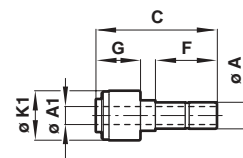

Stem reducer

(stem/tube)

ø A	ø A1	C	F	G	ø K1	Model
5	4	32,0	16,5	11,5	13,5	D00230504
6	4	33,5	18,0	11,5	13,5	D00230604
6	5	34,5	18,5	12,0	13,5	D00230605
8	4	34,5	18,5	11,5	13,5	D00230804
8	5	35,0	19,0	12,0	13,5	D00230805
8	6	37,0	19,0	13,5	15,0	D00230806
10	6	40,5	27,0	13,5	15,0	D00231006
10	8	41,0	22,5	13,5	18,0	D00231008
12	8	40,0	25,5	13,5	18,0	D00231208
12	10	48,0	25,5	15,5	20,0	D00231210



D0115

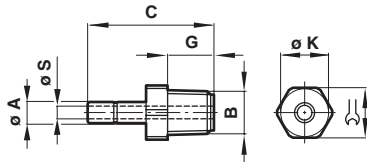

Stem adaptor

(stem/tube)

ϕA	B	C	G	K	ϕS		Model
4	R1/8	33,0	10,0	15,0	2,5	9/16	D01150418
4	R1/4	36,5	13,5	18,0	2,5	11/16	D01150428
5	R1/8	33,0	10,0	15,5	3,0	9/16	D01150518
5	R1/4	36,0	13,5	18,0	3,0	11/16	D01150528
6	R1/8	34,0	10,0	15,0	4,3	9/16	D01150618
6	R1/4	38,0	14,0	18,0	4,3	11/16	D01150628
8	R1/8	34,5	10,0	15,0	4,8	9/16	D01150818
8	R1/4	39,5	14,0	18,0	4,8	11/16	D01150828
8	R3/8	39,5	14,0	22,0	4,8	13/16	D01150838
10	R1/4	42,5	14,0	18,0	6,5	11/16	D01151028
10	R3/8	43,0	14,0	22,0	6,5	13/16	D01151038
10	R1/2	46,0	17,5	27,0	6,7	1	D01151048
12	R3/8	48,0	14,0	27,0	6,7	1	D01151238
12	R1/2	51,0	19,0	28,0	6,7	1	D01151248

D0215

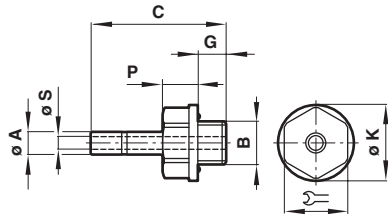

Stem adaptor

BSP(P)

ϕA	B	C	G	ϕK	P	ϕS		Model
4	G1/8	30,5	6,5	17,0	8,0	2,5	9/16	D02150418
4	G1/4	34,5	10,0	20,5	8,0	2,5	11/16	D02150428
5	G1/8	31,0	6,5	17,0	8,0	3,0	9/16	D02150518
5	G1/4	34,5	10,0	20,5	8,0	3,0	11/16	D02150528
6	G1/8	32,0	6,5	17,0	8,0	4,3	9/16	D02150618
6	G1/4	35,5	10,0	20,5	8,0	4,3	11/16	D02150628
8	G1/8	33,0	6,5	17,0	8,0	4,8	13/16	D02150818
8	G1/4	36,5	10,0	20,5	8,0	4,8	1	D02150828
8	G3/8	37,0	10,0	26,5	8,0	4,8	13/16	D02150838
10	G1/4	40,5	10,0	20,5	8,0	6,5	11/16	D02151028
10	G3/8	39,5	9,0	26,5	8,0	6,5	13/16	D02151038
10	G1/2	44,0	13,5	29,0	8,1	6,7	1	D02151048
12	G3/8	43,5	10,0	26,5	8,1	9,5	13/16	D02151238
12	G1/2	47,0	13,5	29,0	8,1	9,5	1	D02151248

D0040

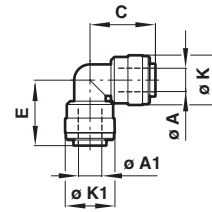

Union elbow

ϕA	$\phi A1$	C	E	ϕK	$\phi K1$	Model
4	4	17,5	17,5	13,0	13,0	D00400400
5	5	17,5	17,5	13,0	13,0	D00400500
6	6	20,0	20,0	15,0	15,0	D00400600
8	4	21,0	21,0	18,0	13,0	D00400804
8	5	21,0	21,0	18,0	13,0	D00400805
8	6	21,0	21,0	17,5	17,5	D00400806
8	8	21,0	21,0	17,5	17,5	D00400800
10	6	23,5	23,5	19,5	15,0	D00401006
10	8	25,5	25,0	19,5	19,5	D00401008
10	10	25,5	25,5	19,5	19,5	D00401000
12	6	25,5	25,0	9,5	19,5	D00401206
12	8	25,5	25,5	19,5	19,5	D00401208
12	10	31,0	30,0	22,5	22,75	D00401210
12	12	31,0	31,0	22,5	22,5	D00401200

D0145

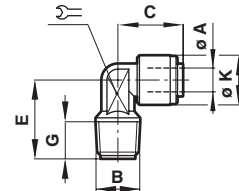

Elbow adaptor

ϕA	B	C	E	G	ϕK		Model
6	R1/8	19,5	20,0	10,0	15,0	3/8	D01450618
6	R1/4	24,5	24,0	11,0	15,0	3/8	D01450628
6	R3/8	19,5	22,0	12,0	15,0	3/8	D01450638
8	R1/4	25,0	23,5	11,0	20,0	9/16	D01450828
8	R3/8	25,0	24,0	12,0	20,0	9/16	D01450838
10	R1/4	25,0	24,0	11,0	20,0	9/16	D01451028
10	R3/8	25,0	24,0	12,0	20,0	9/16	D01451038
12	R3/8	31,0	30,0	12,0	23,0	11/16	D01451238
12	R1/2	31,0	31,5	16,0	23,0	11/16	D01451248

D0147

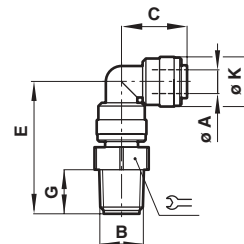

90° Swivel elbow adaptor

ϕA	B	C	E	G	ϕK		Model
4	R1/8	16,5	30,5	10,0	13,0	9/16	D01470418
4	R1/4	16,5	30,5	13,5	13,0	11/16	D01470428
5	R1/8	17,0	30,5	10,0	13,0	9/16	D01470518
6	R1/8	20,0	34,5	10,0	15,0	9/16	D01470618
6	R1/4	20,0	34,0	13,5	15,0	11/16	D01470628
8	R1/8	21,5	36,5	10,0	17,5	9/16	D01470818
8	R1/4	21,5	36,5	13,5	17,5	11/16	D01470828
8	R3/8	21,5	36,5	14	17,5	13/16	D01470838
10	R1/4	25,5	42,0	13,5	19,5	11/16	D01471028
10	R3/8	25,5	42,0	14	19,5	13/16	D01471038
12	R3/8	31,0	49,0	14	22,5	13/16	D01471238
12	R1/2	31,0	49,0	19,0	22,5	1	D01471248



D0247

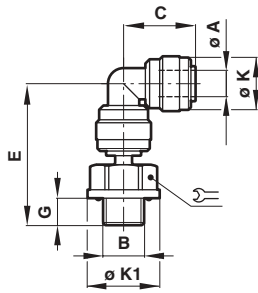

90° Swivel elbow adaptor
(BSPP)

ø A	B	C	E	G	ø K	ø K1	⌀	Model
4	G1/8	16,5	33,5	6,5	13,0	17,0	9/16	D02470418
4	G1/4	16,5	37,0	10,0	13,0	20,5	11/16	D02470428
5	G1/8	17,5	34,0	6,5	13,0	17,0	9/16	D02470518
5	G1/4	17,5	37,5	10,0	13,0	20,5	11/16	D02470528
6	G1/8	19,5	36,5	6,5	15,0	17,0	9/16	D02470618
6	G1/4	19,5	40,0	10,0	15,0	20,5	11/16	D02470628
8	G1/8	21,0	37,5	6,5	18,0	17,0	13/16	D02470818
8	G1/4	20,0	41,0	10,0	18,0	20,5	1	D02470828
8	G3/8	21,0	40,5	10,0	18,0	26,0	13/16	D02470838
10	G1/4	25,5	45,5	10,0	20,0	20,5	11/16	D02471028
10	G3/8	25,5	45,5	10,0	20,0	26,0	13/16	D02471038
10	G1/2	25,5	49,0	13,5	20,0	29,0	1	D02471048
12	G3/8	31,0	51,0	10,0	24,0	26,0	13/16	D02471238
12	G1/2	31,0	54,5	13,5	24,0	29,0	1	D02471248

D005A

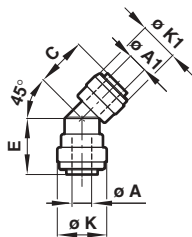

45° Elbow adaptor

ø A	ø A1	C	E	ø K	ø K1	Model
10	6	20,5	21,5	20,0	15,0	D005A1006
12	8	22,5	25,0	23,0	17,5	D005A1208

D0043

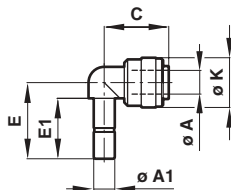

Stem elbow

ø A	ø A1	C	E	E1	ø K	Model
4	4	17,5	21,0	15,5	13,0	D00430400
5	5	17,5	21,0	15,5	13,0	D00430500
6	6	19,5	23,0	18,5	15,0	D00430600
6	10	21,0	31,0	25,0	17,5	D00431006
8	8	21,0	31,0	25,0	17,5	D00430800
8	10	21,0	31,0	25,0	17,5	D00431008
10	10	25,5	36,5	23,0	20,0	D00431000
12	12	29,5	34,5	25,5	23,0	D00431200

D0060

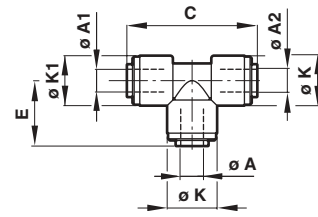

Union tee

ø A	ø A1	ø A2	C	E	ø K	ø K1	Model
4	4	4	35,0	17,5	13,0	13,0	D00600400
5	5	5	35,0	17,5	13,0	13,0	D00600500
6	6	6	39,0	19,5	15,0	15,0	D00600600
8	8	8	42,0	21,0	17,5	17,5	D00600800
10	10	10	50,0	25,0	19,5	19,5	D00601000
12	12	12	60,0	30,0	23,0	23,0	D00601200

D006A

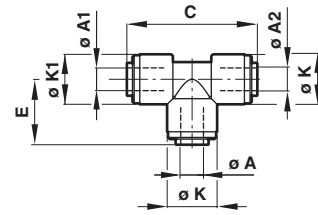

Union tee

ø A	ø A1	ø A2	C	E	ø K	ø K1	Model
6	10	10	50,0	24,0	15,0	19,5	D006A1006
10	12	12	60,0	29,0	23,0	23,0	D006A1210

D006B

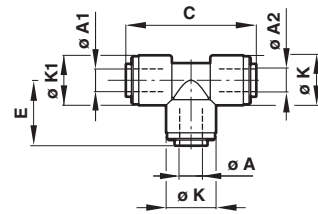

Union tee

ø A	ø A1	ø A2	C	E	ø K	ø K1	Model
12	12	10	59,5	30,5	23,0	23,0	D006B1210

D0167

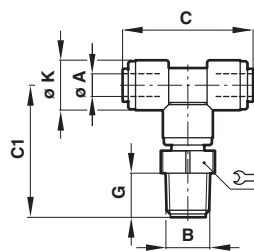

Swivel tee adaptor

ø A	B	C*	C1	G	ø K	⌀	Model
4	R1/8	34,5	34,0	10,0	13,0	9/16	D01670418
4	R1/4	34,5	37,5	13,0	13,0	11/16	D01670428
5	R1/8	34,5	34,0	10,0	13,0	9/16	D01670518
5	R1/4	34,5	39,0	13,0	13,0	11/16	D01670528
6	R1/8	39,5	36,5	10,0	15,0	9/16	D01670618
6	R1/4	39,5	40,0	13,0	15,0	11/16	D01670628
8	R1/8	41,5	37,5	10,0	18,0	9/16	D01670818
8	R1/4	41,5	41,0	13,0	18,0	11/16	D01670828
8	R3/8	41,5	41,5	14,0	18,0	13/16	D01670838
10	R1/4	50,0	45,0	13,0	20,0	11/16	D01671028
10	R3/8	50,0	45,5	14,0	20,0	13/16	D01671038
10	R1/2	50,0	51,5	17,5	20,0	1	D01671048
12	R3/8	60,0	50,5	14,0	23,0	13/16	D01671238
12	R1/2	60,0	55,5	18,5	23,0	1	D01671248



D0168

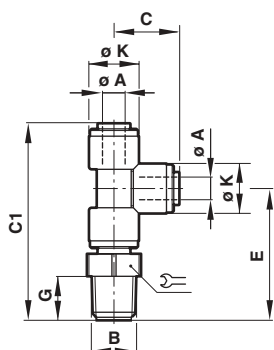

Swivel side tee adaptor

ø A	B	C	C1	E	G	ø K	⌀	Model
4	R1/8	16,5	51,0	35,5	10,0	13,0	9/16	D01680418
4	R1/4	16,5	55,0	39,5	13,5	13,0	11/16	D01680428
5	R1/8	10,0	51,0	14,0	10,0	13,0	9/16	D01680518
5	R1/4	17,0	55,0	39,5	13,5	13,0	11/16	D01680528
6	R1/8	20,0	56,0	37,5	10,0	15,0	9/16	D01680618
6	R1/4	20,0	59,5	41,5	13,5	15,0	11/16	D01680628
8	R1/8	21,5	58,0	38,5	10,0	17,5	9/16	D01680818
8	R1/4	21,5	61,5	43,5	13,5	17,5	11/16	D01680828
8	R3/8	21,5	62,0	43,5	14,0	17,5	13/16	D01680838
10	R1/4	25,0	70,0	48,0	13,5	19,5	11/16	D01681028
10	R3/8	25,0	71,0	48,5	14,0	19,5	13/16	D01681038
12	R3/8	30,0	80,5	53,5	14,0	23,0	13/16	D01681238
12	R1/2	30,0	85,0	58,0	19,0	23,0	1	D01681248

D0268

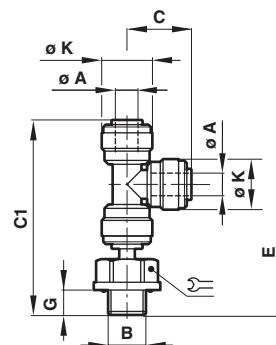

Swivel side tee adaptor

ø A	B	C	C1	E	G	ø K	⌀	Model
4	G1/8	17,0	50,0	43,5	6,5	13,0	9/16	D02680418
4	G1/4	17,0	53,5	47,0	10,0	13,0	11/16	D02680428
5	G1/8	17,5	51,0	44,5	6,5	13,0	9/16	D02680518
5	G1/4	17,5	54,5	48,0	10,0	13,0	11/16	D02680528
6	G1/8	20,0	55,5	48,0	6,5	15,0	9/16	D02680618
6	G1/4	20,0	59,0	51,5	10,0	15,0	11/16	D02680628
8	G1/8	21,0	62,5	50,0	6,5	17,5	13/16	D02680818
8	G1/4	21,0	62,5	53,5	10,0	17,5	1	D02680828
8	G3/8	21,0	62,0	53,0	10,0	17,5	13/16	D02680838
10	G1/4	25,5	71,5	61,5	10,0	20,5	11/16	D02681028
10	G3/8	25,5	71,0	61,0	10,0	20,5	13/16	D02681038
10	G1/2	25,5	74,5	64,5	13,5	20,5	1	D02681048
12	G3/8	30,0	81,5	69,5	10,0	23,5	13/16	D02681238
12	G1/2	30,0	81,5	73,0	13,5	23,5	1	D02681248

D0267

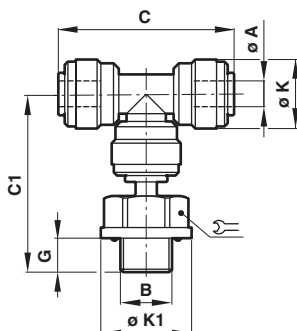

Swivel tee adaptor

ø A	B	C	C1	G	ø K	ø K1	⌀	Model
4	G1/8	27,0	33,0	6,5	13,0	17,0	9/16	D02670418
4	G1/4	27,0	37,0	10,0	13,0	20,5	11/16	D02670428
5	G1/8	27,5	34,0	6,5	13,0	17,0	9/16	D02670518
5	G1/4	27,5	37,5	10,0	13,0	20,5	11/16	D02670528
6	G1/8	32,0	35,5	6,5	15,0	17,0	9/16	D02670618
6	G1/4	32,0	39,0	10,0	15,0	20,5	11/16	D02670628
8	G1/8	33,5	37,0	6,5	18,0	17,0	13/16	D02670818
8	G1/4	33,5	40,5	10,0	18,0	20,5	1	D02670828
8	G3/8	33,5	40,5	10,0	18,0	26,0	13/16	D02670838
10	G1/4	40,5	47,0	10,0	20,0	20,5	11/16	D02671028
10	G3/8	40,5	47,0	10,0	20,0	26,0	13/16	D02671038
10	G1/2	40,5	50,5	13,5	20,0	29,0	1	D02671048
12	G3/8	49,0	49,0	10,0	24,0	26,0	13/16	D02671238
12	G1/2	49,0	51,5	13,5	24,0	29,0	1	D02671248

D0082

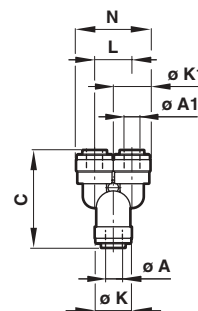

Union Y

(equal)

ø A	ø A1	C	ø K	ø K1	L	N	Model
4	4	39,0	13,0	13,0	12,5	30,0	D00820400
6	6	39,0	15,0	15,0	15,0	30,0	D00820600
8	8	43,5	17,5	17,5	17,0	34,5	D00820800
10	8	48,5	20,0	17,5	17,0	39,5	D00821008
10	10	48,5	20,0	20,0	20,0	39,5	D00821000
12	10	56,5	20,0	23,0	23,0	46,0	D00821210
12	12	56,5	23,0	23,0	23,0	46,0	D00821200



D0089

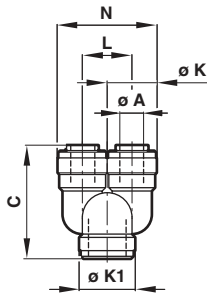

U bend

ø A	C	ø K	ø K1	L	N	Model
6	34,5	15,0	17,0	15,0	30,0	D00890600
8	36,5	17,5	19,5	17,0	34,5	D00890800
10	40,5	20,0	22,0	19,5	39,5	D00891000
12	47,5	23,0	25,0	22,5	45,5	D00891200

D00GL

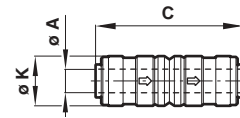

Check valve

ø A	C	ø K	Model
6	45,5	15,0	D00GL0600
8	47,5	17,5	D00GL0800
10	53,0	20,0	D00GL1000
12	60,5	23,0	D00GL1200

D0090

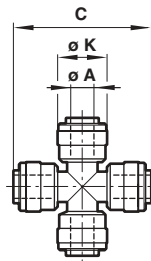

Union Cross

ø A	C	C1	ø K	Model
4	33,0	33,0	13,0	D00900400
6	42,0	42,0	15,0	D00900600
8	42,5	42,0	17,5	D00900800
10	50,5	50,5	20,0	D00901000
12	58,5	58,5	23,0	D00901200

D00GR

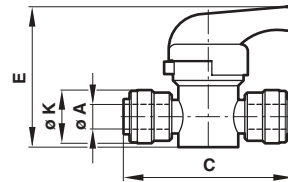

Hand valve 2/2 Shut-off

(tube to tube)

ø A	C	E	ø K	Model
6	48,0	39,5	15,0	D00GR0600
10	58,0	47,0	20,0	D00GR1000
12	66,5	45,5	23,0	D00GR1200

D01GT

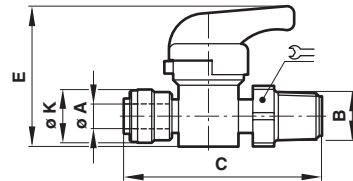

Hand valve 2/2 Shut-off

(tube to male thread)

ø A	B	C	E	ø K	⌀	Model
6	R1/4	57,0	39,5	15,0	11/16	D01GT0628
10	R3/8	62,5	45,5	20,0	3/4	D01GT1038
12	R1/2	71,5	45,5	23,0	1	D01GT1248

D0091

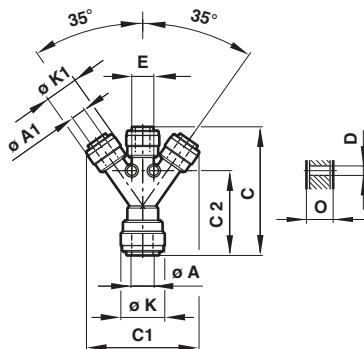

3 way splitter

ø A	ø A1	C	C1	C2	D	E	ø K	ø K1	O	Model
10	6	58,5	51,5	38,5	4,3	10,0	20,0	15	0,85	D00911006
12	10	71,5	67,0	48,0	4,3	14,0	23,0	19,9	0,85	D00911210

D01GU

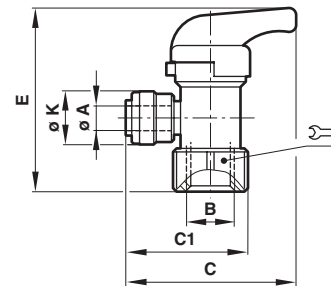

Hand valve 2/2 Shut-off

(tube to female thread)

ø A	B	C	C1	E	ø K	⌀	Model
6	R1/4	48,0	34,3	52,5	15,0	3/4	D01GU0628
10	R3/8	58,5	41,9	58,0	20,0	1	D01GU1038
10	R1/2	58,0	43,0	62,0	20,0	1	D01GU1048
12	R3/8	62,0	47,0	61,0	23,0	1 1/4	D01GU1238
12	R1/2	62,5	47,6	61,0	23,0	1 1/4	D01GU1248



D0004

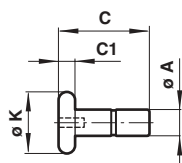

Plug

ø A	C	C1	ø K	Model
4,0	19,5	3,0	12,5	D00040400
5,0	19,5	3,0	12,5	D00040500
6,0	22,0	4,0	15,0	D00040600
8,0	23,0	4,0	17,0	D00040800
10,0	26,5	4,0	19,0	D00041000
12,0	30,0	4,0	21,0	D00041200

D0033

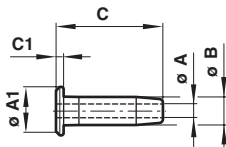

Tube supports

Tube O.D.	ø A	ø B	C	C1	Model
8	8,0	6,0	16,0	1	D00330806
10	10,0	7,0	18,0	1	D00331008
12	12,0	9,0	21,0	1	D00331210

D0033****H

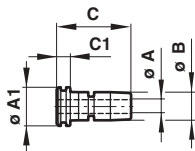

Tube supports

for double seal tube support

ø A,	ø A1	ø B	C	C1	Model
8	7,5	6,0	16,0	3,5	D00330806H
10	10,0	7,0	18,0	3,5	D00331008H
12	12,0	9,0	21,0	4,0	D00331210H

D000A

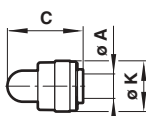

End stop

(female plug)

ø A	C	ø K	Model
6	22,5	15,0	D000A0600
8	23,0	17,5	D000A0800
10	26,5	20,0	D000A1000
12	32,5	23,0	D000A1200

D005B

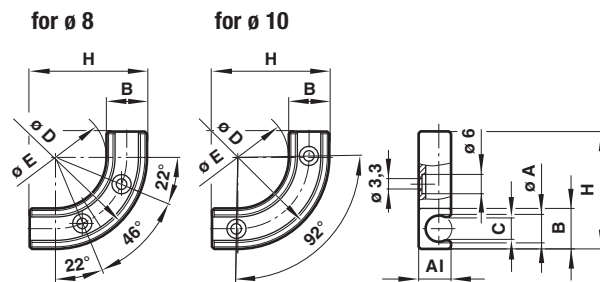

Flow bend tube clip

For ø A	AI	B	C	ø D	H	ø E	Model
8	10,2	12,7	7,5	57,4	36,5	32,0	D005B0800
10	12,2	15,2	9,0	59,9	47,0	29,5	D005B1000

D00GM1000

Shut-off valve mounting clip

(for valve ø 10 only)

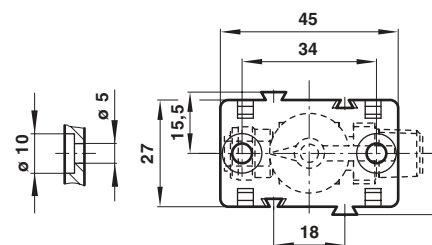
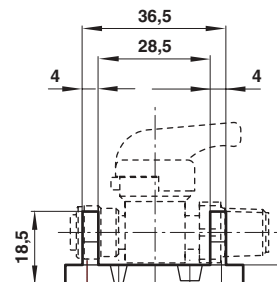



DOLC

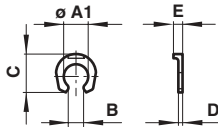

Locking clip

ø A	ø A1	B	C	D	E	Model
6	8,2	5,1	15,0	1,4	3,0	DOLC0600
12	14,5	11,1	21,0	2,6	4,5	DOLC1200

D0008****B

(brass)

and D0008****G

(stainless steel)

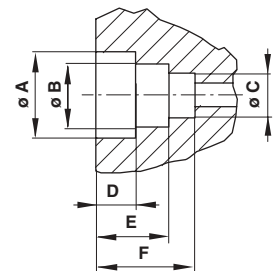
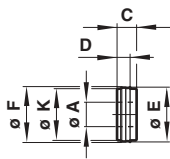

Cartridges

ø A	C	D	ø E	ø F	ø K	Model
4	4,5	3,0	12,6	12,4	11,9	D00080400B
5	4,5	3,0	12,1	11,9	11,4	D00080500B
6	4,5	3,1	13,6	13,4	12,9	D00080600B
8	5,5	3,3	13,9	13,7	13,2	D00080800B
10	7,0	4,3	16,2	16,0	15,6	D00081000B
12	7,5	4,8	19,9	19,6	19,1	D00081200B
4	4,5	3,0	12,6	12,4	11,9	D00080400G
5	4,5	3,0	12,1	11,9	11,4	D00080500G
6	4,5	3,1	13,6	13,4	12,9	D00080600G
8	5,5	3,3	13,9	13,7	13,2	D00080800G
10	7,0	4,3	16,2	16,0	15,6	D00081000G
12	7,5	4,8	19,9	19,6	19,1	D00081200G

Metric one O ring

øA	øA±0.05	øB±0.05	øC±0.05	D+0.25 -0	øE±0.15	øF±0.15
4	12,44	8,05	4,10	4,59	9,39	12,75
5	11,93	8,73	5,10	4,59	9,39	12,75
6	13,46	10,69	6,10	4,59	9,47	13,84
8	13,76	11,81	8,10	5,41	10,50	15,63
10	16,00	14,30	10,10	6,80	11,98	18,27
12	19,68	16,78	12,10	7,69	13,33	21,00

Warning

These products are intended for use in industrial compressed air systems only. Do not use these products where pressures and temperatures can exceed those listed under 'Technical Data'.

Before using these products with fluids other than those specified, for non-industrial applications, life-support systems, or other applications not within published specifications, consult NORGREN.

Through misuse, age, or malfunction, components used in fluid power systems can fail in various modes.

The system designer is warned to consider the failure modes of all component parts used in fluid power systems and to provide adequate safeguards to prevent personal injury or damage to equipment in the event of such failure.

System designers must provide a warning to end users in the system instructional manual if protection against a failure mode cannot be adequately provided.

System designers and end users are cautioned to review specific warnings found in instruction sheets packed and shipped with these products.