

Data sheet | Item number: 769-102/021-000

1-conductor female plug; Locking lever; 4 mm²; 2-pole

www.wago.com/769-102/021-000

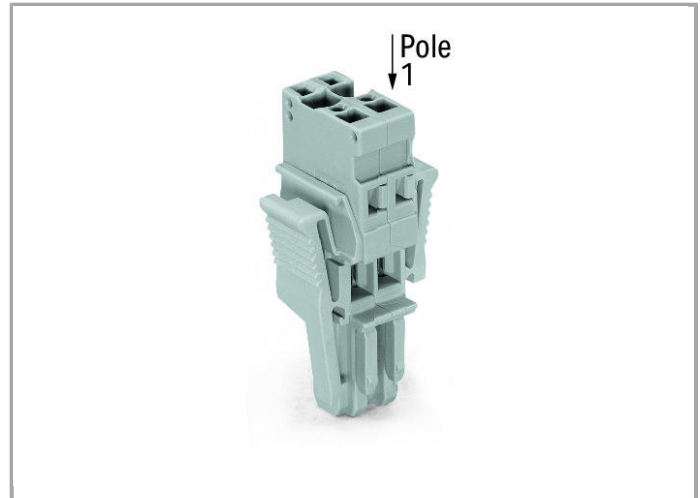

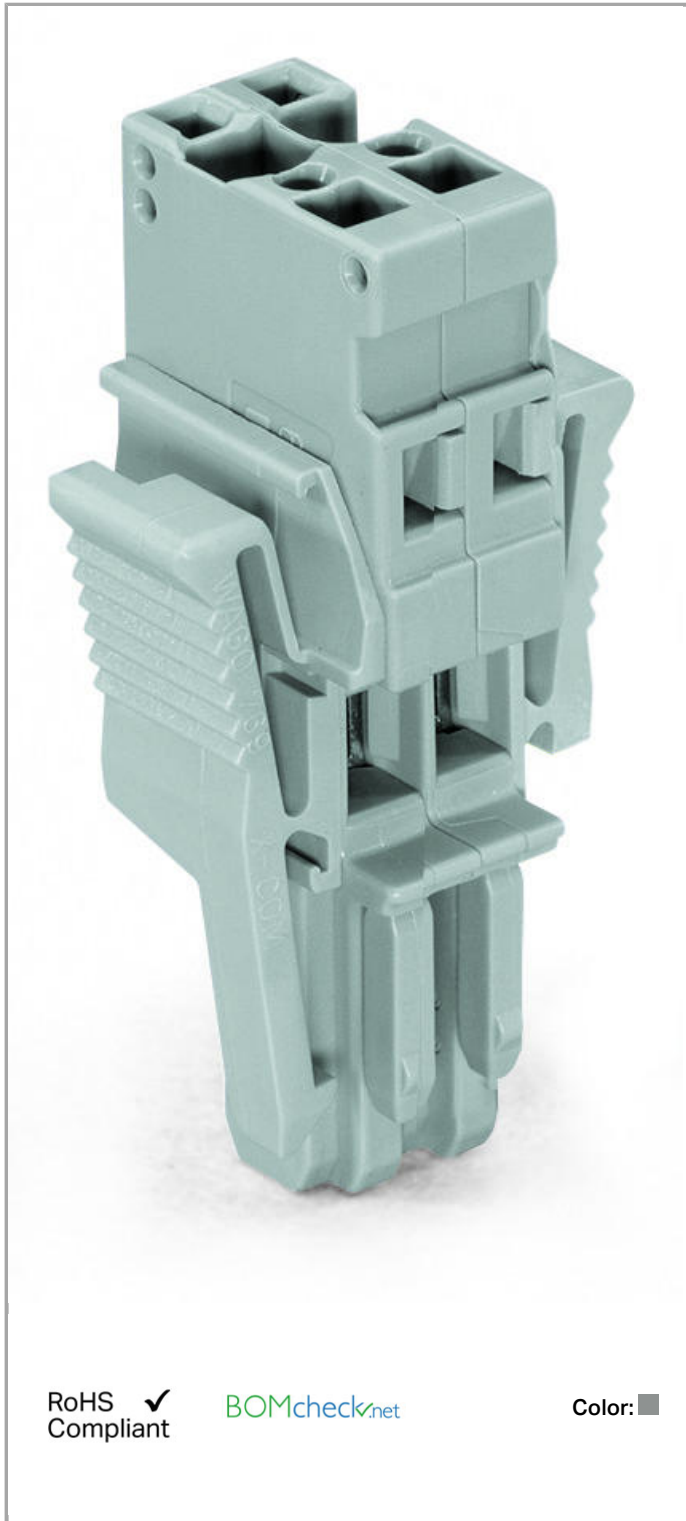
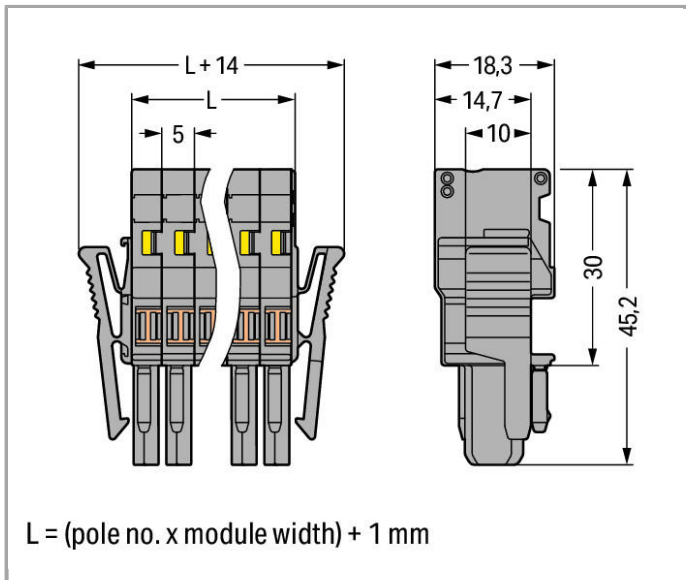

Item description

According to EN 61984, pluggable connectors without current interrupting capacity shall not be mated and unmated when live or under load.

Data

Electrical data

Ratings per IEC/EN 60664-1

Rated voltage (III / 3)	500 V
Rated impulse voltage (III / 3)	6 kV
Rated current	32 A
Legend (ratings)	(III / 3) $\hat{=}$ Overvoltage category III / Pollution degree 3

Connection data

Connection technology	CAGE CLAMP®
Actuation type	Operating tool
Connectable conductor materials	Copper
Nominal cross section	4 mm ²
Solid conductor	0.08 ... 4 mm ² / 28 ... 12 AWG
Fine-stranded conductor	0.08 ... 4 mm ² / 28 ... 12 AWG
Strip length	8 ... 9 mm / 0.31 ... 0.35 Inch
No. of poles	2
Total number of connection points	2
Total number of potentials	2
Type of wiring	Front-entry wiring

Geometrical Data

Width	25.6 mm / 1.008 inch
Height	45.2 mm / 1.78 inch
Depth	18.3 mm / 0.72 inch

Mechanical data

Marking level	Side marking
---------------	--------------

Plug connection





Contact type (pluggable connector)	Female connector/socket
Connector connection type	for conductors

Material Data

Color	gray
Insulating material	Polyamide 66 (PA 66)
Fire load	0.157 MJ
Weight	9.042 g

Approvals / Certificates

Country specific Approvals



Logo	Approval	Certificate name
	CCA	2190419.02
	CCA	NL-47799
	CCA DEKRA Certification B.V.	NTR NL-7626
	CSA DEKRA Certification B.V.	1101144
	KEMA/KEUR DEKRA Certification B.V.	2190419.01

Ship Approvals

Logo	Approval	Certificate name
	ABS American Bureau of Shipping	14-HG1293677-PDA



UL-Approvals

Logo	Approval	Certificate name
	UR Underwriters Laboratories Inc.	E45171
	UR Underwriters Laboratories Inc.	E45172

Product family

X-COM

[Show all products from the family](#)

Subject to changes.