

Product Description

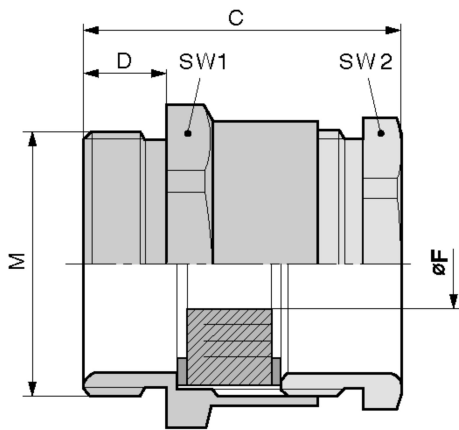

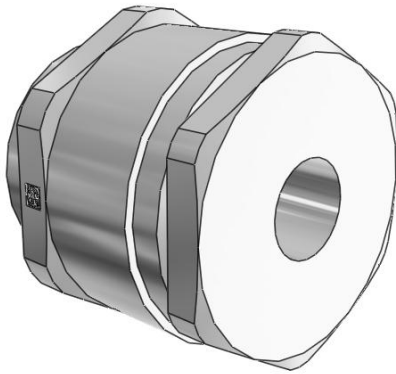

Technical Data

ATN	52105002
M	M 25x1,5
FMIN	9
FMAX	20
F	9
SW1	30
A1	33
SW2	28
A2	31.2
C	29.6
D	7
MATERIAL	Messing vernickelt