



Leica ES2 Leica EZ4 Leica EZ4 W User Manual

Congratulations!

You have just purchased a Leica E Series stereo-microscope – an excellent choice! Viewing entire objects under magnification imparts perspectives and discoveries that would not be possible with the naked eye.

In developing our stereomicroscopes, we have placed great emphasis on simple, self-explanatory operation. However, please take the time to read the instruction manual and the notes on operating safety, to learn about all the features and capabilities of your instrument so that you can use it safely and to its best advantage. Should you have any questions, please consult your local Leica representative. We are gladly at your service!

Chapter Overview

| | |
|---|-----------|
| Safety and Use | 6 |
| Leica ES2 | 14 |
| Leica EZ4 and Leica EZ4 W | 22 |
| Eyepieces (only for Leica EZ4) | 33 |
| Photography Using the Leica EZ4 W | 41 |
| Get Set! | 47 |
| The Camera Remote Control (Optional) | 55 |
| Care, Transport, Contact Persons | 68 |
| Specifications | 70 |
| Dimensions | 72 |

Contents

Safety and Use

| | |
|-----------------------------------|----|
| Symbols Used | 7 |
| Safety Instructions | 8 |
| Regulatory Compliance Information | 10 |
| Instructions for Use | 12 |

Leica ES2

| | |
|---|----|
| Overview: Leica ES2 | 15 |
| Transport, Placement and Storage | 16 |
| The Correct Interpupillary Distance | 17 |
| Using the LED Illuminator | 18 |
| Focusing | 19 |
| Magnification Display | 20 |
| Adjusting the Resistance of the Focus Drive | 21 |

Leica EZ4 and Leica EZ4 W

| | |
|-------------------------------------|----|
| Overview: Leica EZ4 | 23 |
| Instrument Variant: Leica EZ4 W | 24 |
| Transport, Placement and Storage | 25 |
| The Correct Interpupillary Distance | 26 |
| Switching on the LED Illuminator | 27 |
| Controlling the Automatic Shutoff | 28 |
| Illumination Types | 29 |
| Focusing | 30 |

| | |
|---|----|
| Magnification Display | 31 |
| Adjusting the Resistance of the Focus Drive | 32 |

Eyepieces (Only for Leica EZ4)

| | |
|--|----|
| Changing Eyepieces (Only for Leica EZ4, Open Version) | 34 |
| Eyepieces and Eyecups (Only for Leica EZ4, Open Version) | 35 |
| Dioptric Correction (Only for Leica EZ4, Open Version) | 36 |
| Graticules (Only for Leica EZ4, Open Version) | 38 |
| Graticules: Preparation | 39 |
| Inserting the Graticules | 40 |

Photography using the Leica EZ4 W

| | |
|-----------------------|----|
| Introduction | 42 |
| The Basics | 43 |
| Leica EZ4 W: Overview | 44 |
| Unpacking | 46 |

Get Set!

| | |
|--|----|
| USB Mode – Capturing and Adjusting Images Using a Computer | 48 |
| SD Mode – Capturing Images Without a Computer or Without a Wireless Device | 50 |
| Adjusting Settings While in SD Mode | 52 |
| WiFi Mode – Capturing and Adjusting Images Using a Wireless Device | 53 |
| Ethernet Mode – Capturing and Adjusting Images Using a Network | 54 |

Contents (Continued)

The Camera Remote Control (Optional)

| | |
|--|----|
| Optional Remote Control | 56 |
| Viewing Images and Movies With the Optional Remote Control | 57 |
| Calling up the Camera Menu | 58 |
| COLOR (Automatic White Balance) | 59 |
| COLOR (Manual White Balance) | 60 |
| EXPOSURE | 61 |
| RESOLUTION | 62 |
| SETUP CAMERA (Camera Settings) | 63 |
| SETUP ETHERNET | 64 |
| SETUP WiFi | 65 |
| Pairing Cameras With Remotes | 67 |

Care, Transport, Contact Persons

| | |
|----------------------------------|----|
| Care, Transport, Contact Persons | 69 |
|----------------------------------|----|

Specifications

| | |
|----------------|----|
| Specifications | 71 |
|----------------|----|

Dimensions

| | |
|-----------------------------|----|
| Leica ES2 | 73 |
| Leica EZ4 W | 75 |
| Leica EZ4, 10× Eyepieces | 77 |
| Leica EZ4 without Eyepieces | 79 |



Safety and Use

Symbols Used



Read and understand user manual before using this device.

Warning of a danger



This symbol indicates especially important information that must be read and complied with. Failure to comply can cause the following:

- Hazards to personnel
- Functional disturbances or damaged instruments

Warning of hazardous electrical voltage



This symbol indicates especially important information that, if not observed, can cause the following:

- Hazards to personnel
- Functional disturbances or damaged instruments

Danger due to hot surface



This symbol warns against touching hot surfaces, e.g. those of light bulbs.

Important information



This symbol indicates additional information or explanations that intend to provide clarity.

Safety Instructions



Before installing, operating or using the instrument, it is mandatory to read this user manual. In particular, please observe all safety instructions.

The "Safety Concept" brochure contains additional safety information regarding service work, requirements and the handling of the microscope, accessories as well as general safety instructions.

You can combine individual system articles with articles from external suppliers. Please read the user manual and the safety requirements of the supplier.

To maintain the unit in its original condition and to ensure safe operation, the user must follow the instructions and warnings contained in these user manuals.

Warning of a danger



This symbol indicates especially important information that is mandatory to read and observe. Failure to follow these instructions may pose hazards to personnel, cause instrument malfunctions or damage the instrument.

Hazardous electrical voltage



This symbol indicates especially important information that is mandatory to read and observe. Failure to follow these instructions may pose hazards to personnel, cause instrument malfunctions or damage the instrument.

Important information



This symbol indicates additional information or explanations that intend to provide clarity.

EC Declaration of Conformity

Electrically operated accessories are constructed based on the state of the art of technology and are provided with an EC Declaration of Conformity.

Technical Safety

To connect the Leica E Series microscopes to power, use a power cable that meets the power cable specifications in your country. The power socket used has to be equipped with a 16 A or 10 A fuse. Only connect the instrument to a grounded power socket that has been installed according to regulations. The power supply voltage has to correspond to the voltage specified on the identification label. Make sure that the ground connection is neither defective nor interrupted, since otherwise a malfunction poses a risk of fatal injury. Never unplug the power plug with moist or wet hands. There is danger of an electric shock.

Safety Instructions (Continued)

Instrument safety and EMC

Our device has been designed, produced and tested in compliance with

- IEC EN 61010-1: Electrical equipment for measurement, control and laboratory use – Safety – Part one: general requirements
- EN 60950-1: Information technology equipment – Safety – Part one: general requirements
- Radio interference suppression in compliance with EN 55011 class B
- Noise immunity in compliance with DIN EN 61326-1.

The device meets the requirements of EU directives

- 2006/95/EG Low voltage directive
- 2014/30/EU EMC directive
- 2011/65/EU RoHS directive

and carries the CE mark.



The device must be disposed of in accordance with 2012/19/EU WEEE directive.

Intended for indoor use only in all EU member states, EFTA states and Switzerland.

Leica EZ4 W

- EN 300328: Electromagnetic compatibility and Radio spectrum Matters (ERM); Wide-band transmission systems; Data transmission equipment operating in the 2,4 GHz ISM band and using wide band modulation techniques; Harmonized EN covering essential requirements under article 3.2 of the R&TTE directive.

Regulatory Compliance Information

FCC Requirements for Operation in the United States

FCC radio frequency interference warnings and instructions

This equipment has been tested and found to comply with the limits for a **Class B digital device**, pursuant to Part 15 of the FCC Rules. These limits are designed to provide reasonable protection against harmful interference in a residential installation. This equipment generates, uses and can radiate radio frequency energy and, if not installed and used in accordance with the instructions, may cause harmful interference to radio communications. However, there is no guarantee that interference will not occur in a particular installation. If this equipment does cause harmful interference to radio or television reception, which can be determined by turning the equipment off and on, the user is encouraged to try to correct the interference by one or more of the following measures:

- Reorient or relocate the receiving antenna.
- Increase the separation between the equipment and receiver.

- Connect the equipment into an outlet on a circuit different from that to which the receiver is connected.
- Consult the dealer or an experienced radio/TV technician for help.

FCC information to user

This product does not contain any user serviceable components and is to be used with approved antennas only.

Any product changes or modifications will invalidate all applicable regulatory certifications and approvals.

FCC guidelines for human exposure

This equipment complies with FCC radiation exposure limits set forth for an uncontrolled environment. This equipment should be installed and operated with minimum distance of 20 cm between the radiator and your body. This transmitter must not be co-located or operating in conjunction with any other antenna or transmitter.

FCC caution

- Any changes or modifications not expressly approved by the party responsible for compliance could void the user's authority to operate this equipment.
- This device complies with Part 15 of the FCC Rules. Operation is subject to the following two conditions: (1) This device may not cause harmful interference, and (2) this device must accept any interference received, including interference that may cause undesired operation.
- This device and its antenna(s) must not be co-located or operation in conjunction with any other antenna or transmitter.

Regulatory Compliance Information (Continued)

Canada (IC)

This device complies with Industry Canada licence-exempt RSS standard(s). Operation is subject to the following two conditions:

- (1) this device may not cause interference, and
- (2) this device must accept any interference, including interference that may cause undesired operation of the device.

Canada (IC)

Le présent appareil est conforme aux CNR d'Industrie Canada applicables aux appareils radio exempts de licence. L'exploitation est autorisée aux deux conditions suivantes:

- (1) l'appareil ne doit pas produire de brouillage, et
- (2) l'utilisateur de l'appareil doit accepter tout brouillage radioélectrique subi, même si le brouillage est susceptible d'en compromettre le fonctionnement.

Australia and New Zealand Notices

This device equipment complies with the Australian and New Zealand regulatory approvals requirements.



Instructions for Use

Intended use

The E Series microscopes are optical instruments for improving the visibility of objects through magnification and illumination. It is used for observing and documenting.

Place of use

Use the instrument in enclosed, dust-free rooms at +10 °C to +40 °C only. Protect it from oil, chemicals and extreme humidity. It must be at least 10 cm from the wall and away from flammable substances.

Interference

Avoid large temperature fluctuations, direct sunlight and vibrations. These conditions can distort measurements and micrographic images.



In warm and warm-damp climatic zones, the individual components require special care in order to prevent the build-up of fungus.

Use in clean rooms

Leica E Series microscopes can be used in clean rooms without any problems.

Handling electrical components



Never install any other plug (NEMA 5-15P) or unscrew any mechanical components unless expressly instructed to do so in the instructions.



The microscope must be connected to a grounded outlet.



Always position the microscope so that you can disconnect it from the power supply at any time. The power cable is provided as the power disconnect device.

Instructions for Use (Continued)

Intervention from the user



The microscopes of the E Series contain no components that can be maintained or repaired by the user. Exceptions are mentioned specifically in this manual.



Unless otherwise specified in this manual, repair and service work may be carried out by authorized Leica technicians only.



Unauthorized alterations to the instrument or noncompliant use shall void all rights to any warranty claims.

Maintenance



Leica E Series microscopes are basically maintenance-free. To ensure that it always operates safely and reliably, we recommend that you take the precaution of contacting the responsible service organization. Here you can arrange for periodic inspections and conclude a maintenance contract (recommended).

Accessories

Only those accessories may be used that are listed in this user manual or for which safe use has been confirmed by Leica Microsystems.

Danger of infection



Direct contact with eyepieces is a potential transmission method for bacterial and viral infections of the eye. The risk can be kept to a minimum by using personal eyepieces for each individual or detachable eyecups.

Dangers during use

The microscope illumination is in the exempt group (risk group 0) according to EN 62471:2008 when used according to its intended use.



Never look directly into the LED beam of the illumination equipment – either with or without optical instruments – as this increases the risk class. Failure to observe this notice poses a risk of eye damage.

Leica ES2

Overview: Leica ES2



1. *10× fixed eyepieces for eyeglass wearers*
2. *Carrying handle*
3. *Two-level magnification changer 10× and 30×*
4. *Focusing drive*
5. *Integrated LED incident light illumination*
6. *Integrated LED transmitted illumination*
7. *Switch for incident and transmitted light*

Transport, Placement and Storage

Built-in carrying device



All Leica E Series microscopes are equipped with a carrying handle for convenient and safe transport.



Setting up the microscope

1. Place the microscope on a flat tabletop.
2. Connect the power supply to a grounded socket.



Packing the device away

1. After use, wind up the cable as shown in the illustration.
2. Store the instrument so that it is protected against dust.



The Correct Interpupillary Distance

The ideal image

 The interpupillary distance is correctly set if you see a single circular image field when looking at a specimen.

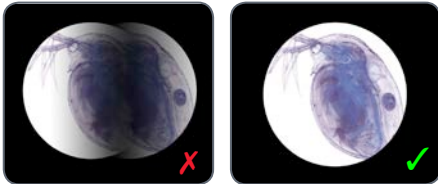

You may need a short time to become familiar with using the instrument. Not to worry – after a little while, it will become automatic.

Note for eyeglass wearers

 If you wear glasses, fold the eyecups back – otherwise, fold the eyecups forwards.

Setting the eye distance

1. Look into the eyepieces.
2. Hold the eyepieces with both hands. Push the eyepieces together or separate them until you see a circular image.



Using the LED Illuminator

Illuminating the specimen

1. Position a specimen in the middle of the baseplate.
2. Switch the two LED illuminators on or off as desired.



After switching off, the LEDs remain lit for about another 4 seconds.

Tips on use

- Use incident light for plastic, opaque objects.
- Use transmitted light for transmitted light specimens or transparent objects.
- Use the combination of both LED illuminators for partially transparent objects.

Focusing

i Focusing raises and lowers the stereo-microscope using the focusing drive. The specimen is brought into sharp focus as soon as it is in the focal point of the objective.

The focusing drive can be operated either left- or right-handed.

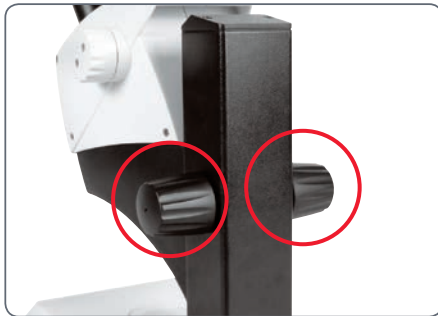

Focusing drive torque

Focusing

1. Set the magnification changer to the lowest level (10).



2. Set the working distance to approx. 100 mm for coarse focusing.



3. Set the magnification changer to the second level (30).
4. Use the focusing drive once again for fine focus.

i After you have adjusted the image sharpness at high magnification, it is maintained even if you switch to a lower magnification (parfocal).

Magnification Display

 You can read the configured magnification on the right-hand rotary knob of the Leica ES2. The additional magnification provided by the eyepieces is already incorporated in the scale.



Adjusting the Resistance of the Focus Drive

Adjusting the resistance

Is the focusing drive too easy or too difficult to adjust? No problem – the resistance can be adjusted individually depending on your personal preferences:

1. Grip the drive knobs with both hands and turn them towards each other until the desired resistance is reached during focusing.

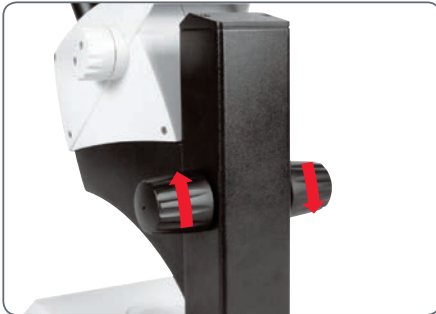

Leica EZ4 and Leica EZ4 W

Overview: Leica EZ4

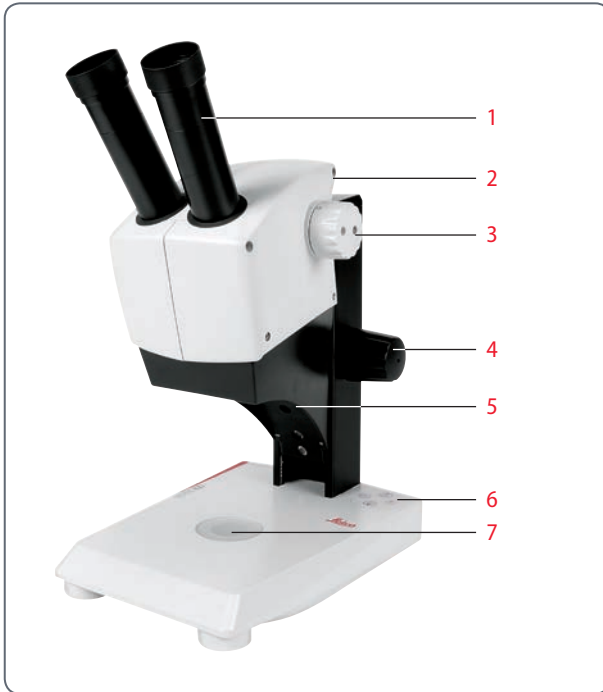

1. *10× fixed eyepieces for eyeglass wearers*
2. *Carrying handle*
3. *Magnification changer*
4. *Focusing drive*
5. *Integrated LED incident light illumination*
6. *Illumination control*
7. *Integrated LED transmitted illumination*

Instrument Variant: Leica EZ4 W



1. *10× fixed eyepieces for eyeglass wearers*
2. *Integrated digital camera with SD card slot*
3. *Mode selection panel*
4. *Carrying handle*
5. *Magnification changer*
6. *IR receiver for optional remote control*
7. *Focusing drive*
8. *Integrated LED incident light illumination*
9. *Illumination control*
10. *Integrated LED transmitted illumination*

Transport, Placement and Storage

Built-in carrying device



All Leica E Series microscopes are equipped with a holder for convenient and safe transport.



Setting up the microscope

1. Place the microscope on a flat tabletop.
2. Connect the power supply to a grounded socket.



Packing the device away

1. After use, wind up the cable as shown in the illustration.
2. Store the instrument so that it is protected against dust.



The Correct Interpupillary Distance

The ideal image

 The interpupillary distance is correctly set if you see a single circular image field when looking at a specimen.

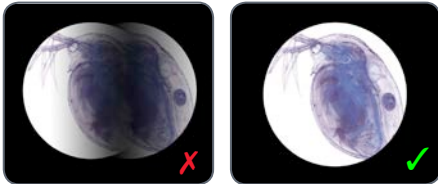

You may need a short time to become familiar with using the instrument. Not to worry – after a little while, it will become automatic.

Note for eyeglass wearers

 If you wear glasses, fold the eyecups back – otherwise, fold the eyecups forwards.

Setting the eye distance

1. Look into the eyepieces.
2. Hold the eyepieces with both hands. Push the eyepieces together or separate them until you see a circular image.



Switching on the LED Illuminator

Automatic shutoff

 If the illumination is not operated for 60 minutes, it switches off automatically. The illumination can be reactivated by pressing a button on the membrane keypad.

LED illumination

1. Position a specimen in the middle of the baseplate.

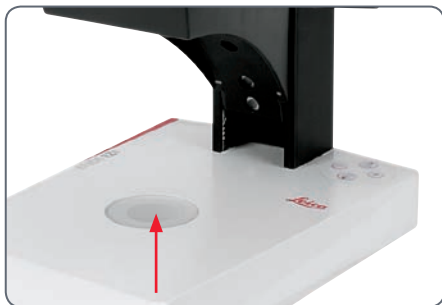

2. Switch the two LED illuminators on or off as desired:

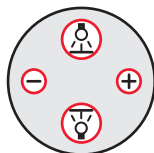

- Use incident light for plastic, opaque objects
- Use transmitted light for transmitted light specimens or transparent objects.
- Use the combination of both LED illuminators for partially transparent objects.

 For a detailed description of the illuminator, refer to [page 29](#).

Controlling the Automatic Shutoff



Automatic shutoff



The factory settings of the EZ4 models switch the instrument off automatically after one hour without user interaction. This automatic shutoff helps to conserve the light-emitting diodes and save energy.

Disabling the automatic shutoff



To disable the automatic shutoff, follow these steps:

1. Switch the microscope off.
2. Press and hold the  and  buttons on the light control unit simultaneously while you switch on the microscope.

The LEDs flash twice slowly and then remain switched on. The automatic shutoff is now disabled.

Enabling the automatic shutoff

To re-enable the automatic shutoff, follow these steps:

1. Switch the microscope off.
2. Press and hold the  and  buttons on the light control unit simultaneously while you switch on the microscope.

The LEDs flash three times slowly and then remain switched on. The automatic shutoff is now re-enabled.

Illumination Types

Three-level incident light illumination

i The incident light illumination is made up of 5 LEDs. Two, three or five diodes are switched on depending on the level. Accordingly, the angle of incidence of the light beam on the object is switched from high to low.

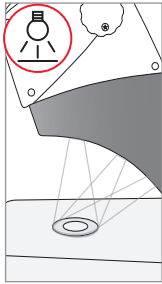

Press 1x
Five diodes: greatest brightness for incident light objects

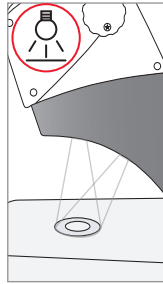

Press 2x
Top three diodes: shadowless uniform lighting for objects with highly uneven surfaces

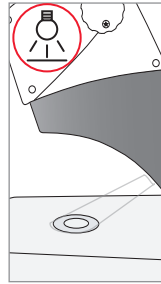

Press 3x
Two diodes: side light emphasizes structures and increases the contrast

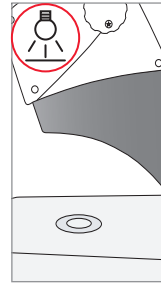

Press 4x
Incident light off

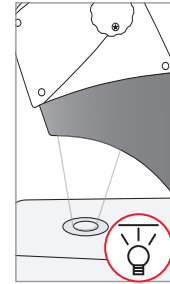

Press 1x
Switch on transmitted light for transparent objects and transmitted light specimens

Regulating brightness

The brightness is adjusted using the ⊖ and ⊕ keys and affects all switched-on LEDs.

Focusing

i Focusing raises and lowers the stereo-microscope using the focusing drive. The specimen is brought into sharp focus as soon as it is in the focal point of the objective.

The focusing drive can be operated either left- or right-handed.

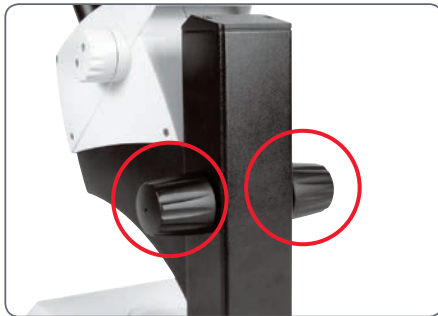

Focusing drive torque

Focusing

1. Set the magnification changer to the lowest level (8).



2. Set the working distance to approx. 100 mm for coarse focusing.



3. Set the magnification changer to the second level (35).

4. Use the focusing drive once again for fine focus.

i After you have adjusted the image sharpness at high magnification, it remains constant even if you switch magnification levels (parfocal).

Magnification Display

 You can read the configured magnification on the right-hand rotary knob of the Leica EZ4 models. The additional magnification provided by the eyepieces is already incorporated in the scale



Leica EZ4 models with open tubes

 On the Leica EZ4 model without eyepieces, only the magnification factors of the magnification changer are indicated: 0.8, 1, 1.25, 1.6, 2, 2.5, 3, 3.5.

 Different total magnifications are possible depending on which eyepieces are used with the Leica EZ4. The magnification of the eyepieces is indicated on their outer surfaces, e.g. 10×/20, 16×/16 or 20×/12.

Adjusting the Resistance of the Focus Drive

Adjusting the resistance

Is the focusing drive too easy or too difficult to adjust? No problem – the resistance can be adjusted individually depending on your personal preferences:

1. Grip the drive knobs with both hands and turn them towards each other until the desired resistance is reached during focusing.

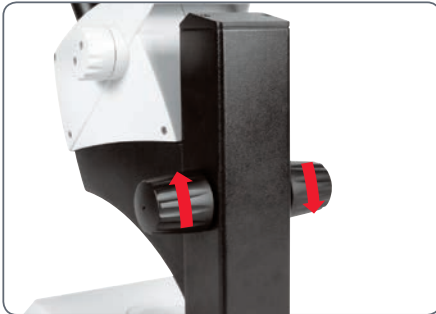

Eyepieces (Only for Leica EZ4)

Changing Eyepieces (Only for Leica EZ4, Open Version)

Changing eyepieces

Various eyepieces are available for the Leica EZ4, allowing the stereomicroscope to be adapted even better to the specific requirements.

The following eyepieces are available for selection:

- Eyepieces replaceable, fixed or adjustable: 10×/20, 16×/16 or 20×/12
- Eyepieces for eyeglass wearers 10×/20B and 16×/15B, fixed and adjustable

The interchangeable eyepieces also offer the following advantages:

- The dioptric range is adjustable from +5 to -5
- Measurement graticules can be used, see [page 38](#) and the following.



Adjustable eyepieces for eyeglasses with straight eyecups

Eyepieces and Eyecups (Only for Leica EZ4, Open Version)

Eyecups

The eyecups can be replaced.

Risk of infection



Direct contact with eyepieces is a potential transmission method for bacterial and viral infections of the eye. The risk can be minimized by the use of individual eyecups.



Eyeglass eyepiece with adjustable diopter and straight eyecups



Eyepiece for users who do not wear eyeglasses with adjustable diopter and inclined eyecup



Fixed eyepiece with inclined eyecup

Dioptric Correction (Only for Leica EZ4, Open Version)

Dioptric correction



The adjustable eyepieces for the Leica EZ4 are also available with built-in dioptric correction, allowing the microscope to be used without glasses even by those with vision problems. The correction comprises a maximum of ± 5 diopter settings.



Users with normal vision do not need adjustable eyepieces. An adjustable eyepiece is sufficient for mild shortsightedness.

If vision is extremely poor or when graticules are used, two adjustable eyepieces are needed.

When the diopters are regulated exactly, the sharpness is constant over the entire magnification range (=parfocal).

Once the diopters have been set, the procedure does not have to be repeated. Simply restore your diopter values on the eyepiece before beginning work with the stereomicroscope

Adjusting

1. Set the dioptric correction for both eyepieces to "0".
2. Select the lowest magnification and focus on a flat specimen.
3. Select the highest magnification and readjust the sharpness.
4. Select the lowest magnification again, but do not look into the eyepieces.
5. Carry out steps 6 to 8 for each objective individually.
6. Rotate the eyepiece counterclockwise in the "+" direction as far as it will go (+5 diopter settings).

Dioptric Correction (Continued)

7. Look into the eyepiece.
8. Slowly rotate the eyepiece individually in the "-" direction until the eye sees the object sharply imaged.
9. Select the highest magnification and refocus if necessary.

Now, if you adjust the magnification from the highest to the lowest level, the specimen is always brought into sharp focus. If not, repeat the process.

Graticules (Only for Leica EZ4, Open Version)

Graticules



The transparent graticules can be inserted in the adjustable eyepieces of the Leica EZ4. They enable easy measurements at the specimen.



For equipment with a graticule in one eyepiece, two adjustable eyepieces are needed. Since one eye is focussed on the eyepiece with the graticule, it needs a second, adjustable eyepiece so that it can be aligned optically with the first.

| Available eyepiece inserts | |
|----------------------------|----------------------------------|
| Graticules | 10 mm/ 0.1 mm |
| | 5 mm/ 0.1 mm |
| | 5 mm/ 0.05 mm |
| | 100 Div / 0.002" |
| | 100 Div / 0.001" |
| Stage micrometers | 150 Div / 0.0005" |
| | 50 mm (0.1 / 0.01 mm graduation) |
| Crosshairs | 1" (0.001" graduation) |
| | Crosshairs |

Graticules: Preparation

Care instructions



The graticule must always be clean and dust-free! Never touch the graticule with bare hands! Always hold the graticule by the edges!

Variant 1: 10× and 20× eyepieces

The 10× and 20× adjustable eyepieces include an insert at the bottom with a snap mount.

1. Gently press the two small tabs on the snap mount together and pull out the insert.



Variant 2: 16× eyepieces

On the 16× adjustable eyepieces, the insert is fixed to the eyepiece by a screwed connection.

1. Screw the insert out counterclockwise.



Inserting the Graticules

Inserting the graticules is the same for all eyepiece types.

1. Place the insert with the knurled side on the work surface.
2. Grasp the graticule so that you see the scale in laterally correct form.
3. Carefully take hold of the edge of the graticule and push it sideways into the holder in the insert. Make sure that both plastic holders snap into place.



4. Put the insert back into the eyepiece. Depending on the variant, you have to either press or twist the insert into place.



6. Align the graticules by turning the eyepiece in the tube.

5. Insert the eyepiece into the tube.





Photography

Using the Leica EZ4 W

Introduction

Thank you for purchasing the Leica EZ4 W by Leica Microsystems. The special design of the Leica EZ4 W makes it a universal, highly versatile tool for viewing microscopic specimens and capturing still images or video.

The Basics

i Your Leica HD camera has many possibilities for various applications and conditions of use. Below are some basic concepts to help you get the most performance for your application.

Modes of use

1. SD mode

- capture onto SD card
- use remote control

2. WiFi mode

- Wireless connection to wireless device (tablet, phone, PC)

3. USB mode

- Cabled connection to PC

4. Ethernet mode

- Cabled connection to external network

5. Capture button

- Captures image onto the SD card

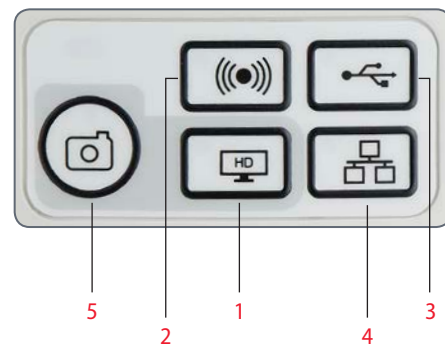

i Note direct connection to an HD display is possible in all modes. Aspect ratio is 16:9 except in USB mode where the aspect ratio is 4:3.

Leica EZ4 W: Overview

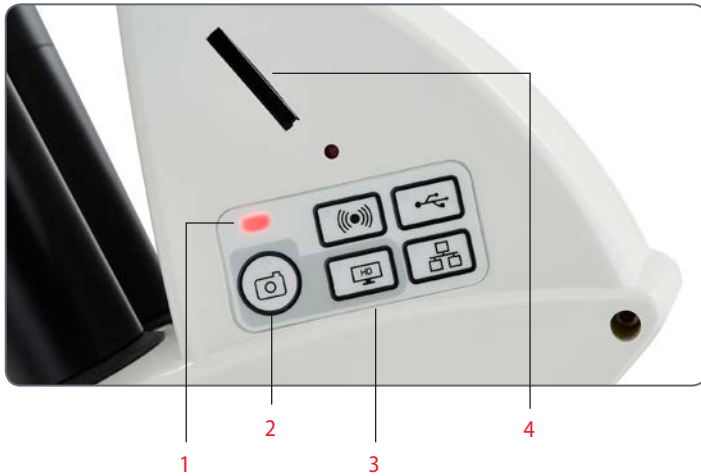

1. LED status indicator
 - *Blinking red means starting up*
 - *Green means ready*
2. Capture button for SD card capture
3. Mode selection panel
4. SD card slot

Leica EZ4 W: Overview (Continued)



1 2 3

1. *HDMI for connecting the provided HDMI cable*
2. *Ethernet socket for connecting an ethernet cable (cable not provided)*
3. *USB for connecting the provided USB cable*



Front

Infrared window: Receives the signal from the optional remote control.

Unpacking

 Please do not discard any of the packing materials. They should be used for safely storing and transporting the instrument should the need arise.



The contents include CD with imaging software, HDMI cable, and USB cable.



If you ordered the handheld remote, you received the remote with batteries.

Get Set!

USB Mode – Capturing and Adjusting Images Using a Computer

i 10× eyepieces have a fixed circular field of view of 18 mm or more diameter. The Leica EZ4 W's field of view, however, is rectangular with a diagonal of 16.4 mm to ensure an even field on the digital image. As a result, the image field of the camera is smaller than the object field seen through the eyepieces.

Installing and connecting

1. Insert the provided CD into your computer, and follow the instructions to load the software.

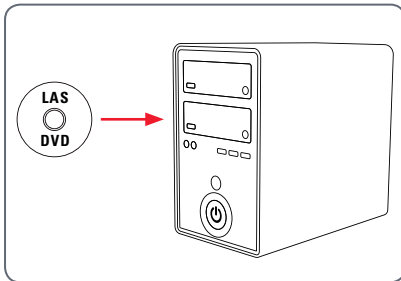

2. Insert the provided USB cable into the camera's USB port, and attach the other end of the cable to a USB 2.0 port of your computer.



3. Switch on the power of the EZ4 W microscope.

4. The status light will blink red. Wait until the status light is green and one of the mode button's is also green. This may take approximately 30 seconds.





USB Mode – Capturing and Adjusting Images Using a Computer (Continued)

5. If a mode button other than USB mode is lit green, then press the USB mode button and wait until both the status LED and the USB mode button is green.



6. You are ready to launch the Leica software. Follow the software instructions to adjust and capture an image.
7. While in USB mode, you can connect the provided HDMI cable from the camera to an HD monitor or HD projector to share the image.

 Note the image aspect ratio while in USB mode is 4:3. To avoid distortion if your projector or monitor is set to a 16:9 aspect ratio, you will need to adjust the aspect ratio of the projector or monitor to 4:3 using the controls of the projector or monitor.

 Note the image resolution on the HD projector or monitor is limited to the live image resolution setting in the software.



4:3 aspect ratio



4:3 aspect ratio image on a screen set to an aspect ratio of 16:9

SD Mode – Capturing Images Without a Computer or Without a Wireless Device

 In order to use this mode, you must have an SD card (not provided) with free memory on it. If the SD memory card is full, the capture button LED will not light green and you will not be able to capture any more images.

Attaching the power cable

1. Switch on the power to the EZ4 W microscope.
2. The status light will blink red. Wait until the status light is green and one of the mode button's is also green. This may take approximately 30 seconds.



3. If a mode button other than SD mode is lit green, then press the SD mode button and wait until both the status LED and the SD mode button is green.



4. Insert the SD memory card into the slot on the side of the Leica EZ4 W until the card clicks into place.



SD Mode – Capturing Images Without a Computer or Without a Wireless Device (Continued)

The capture button LED will turn green. The Leica EZ4 W is now ready to capture images onto the SD memory card.



Capturing an image



It is critical to properly set the microscope eyepieces' diopters to ensure that the images on the SD memory card are in focus when the image is in focus through the microscope's eyepieces. Refer to the microscope's user manual for proper diopter setting. Focus the microscope at high magnification, then change to the magnification at which you wish to capture the image. Do not refocus the microscope. You can also use the HDMI output and an HD display (not provided) as a focusing aid.

5. To capture an image onto the SD memory card, lightly press the capture button, located on the side of the Leica EZ4 W camera.



- You will hear a beep to acknowledge the button was pressed.
- The status LED flashes red while the image is being captured.
- You will hear another beep when the Leica EZ4 W has completed capturing the image and the status LED will return to steady green.

The image is now saved on the SD card. Images which are on the SD card can be viewed using the optional remote control. See "Camera Remote Control" on [page 55](#).

6. While in SD mode, you can connect the provided HDMI cable from the camera to an HD monitor or HD projector to share the image.



Adjusting Settings While in SD Mode

Setting a new white balance

 Make sure that there is no sample in the beam path and that a standard illumination is available when you reset the camera.

Press and hold the capture button for 5 seconds. Wait for the beep. A new white balance is set.



Return to factory settings

Press and hold the service button for 5 seconds. Wait for the beep. The camera will now reset to factory settings.

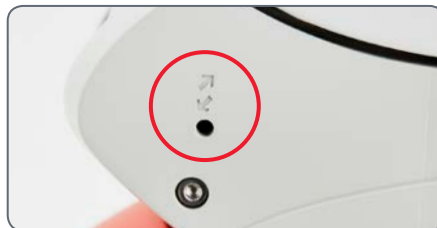

WiFi Mode – Capturing and Adjusting Images Using a Wireless Device

1. Switch on the power to the Leica EZ4 W microscope.
2. The status light will blink red. Wait until the status light is green and one of the mode button's is also green. This may take approximately 30 seconds.
3. If a mode button other than WiFi mode is lit green, then press the WiFi button and wait until both the status LED and the WiFi mode button is green.

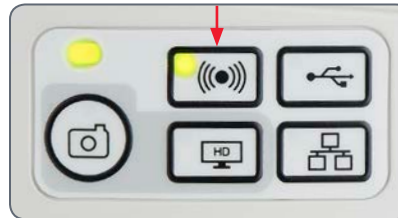

4. Follow the directions of your WiFi viewing device to connect to the internal WiFi network of the camera. WiFi Password: leicamicro
5. Open the appropriate app on your mobile device or appropriate software on your wireless enabled PC for viewing, capturing, and adjusting the camera image.

Ethernet Mode – Capturing and Adjusting Images Using a Network

1. Connect one end of an ethernet cable (not provided) to the camera and the other end of the cable to the ethernet connection in your facility.



2. Switch on the power to the Leica EZ4 W microscope.

3. The status light will blink red. Wait until the status light is green and one of the mode button's is also green. This may take approximately 30 seconds.



4. If a mode button other than ethernet mode is lit green, then press the ethernet button and wait until both the status LED and the ethernet LED mode button is green.



5. Follow the directions of your network compatible device to connect to your facilities network and select the camera.
6. Open the appropriate app on your mobile device or appropriate software on your wireless enabled PC for viewing, capturing, and adjusting the camera image.

The Camera Remote Control (Optional)



The remote control is designed to work only when the camera is in SD mode and when the camera is used in combination with an HD display.

The only function which works in any mode is the "Info" function which shows details about the camera.

Optional Remote Control



The remote control can only work in SD mode except for the "i" button which will display information about the camera on an HD display. The remote must be pointed at the IR receiver of the camera without obstructions.







1. Start/stop video recording
2. Save still image to SD card
3. Stop/continue live image, pause/play movie clip
4. View files on SD card
5. Move to previous image on SD card
6. Move to next image on SD card
7. Brightness adjustment up or down
8. Pairing button
9. Show/hide information box
10. White balance set button
11. Call up the camera menu
12. Arrow keys for navigation
13. OK to confirm

Viewing Images and Movies With the Optional Remote Control

 If you have purchased the optional remote, the Leica HD camera shows images and movie clips directly on an HD monitor.

1. Thumbnail view  (first press)

- up/down/left/right ► select thumbnail
-  Show image in full screen or playback movie clip
- next image  / previous  image
-  ► Play movie clip
- left/right ► fast forward / rewind

2. To return to live view press .

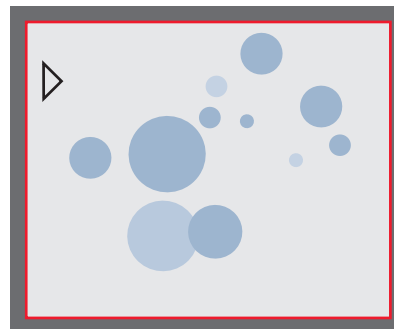

Playback / fullscreen view

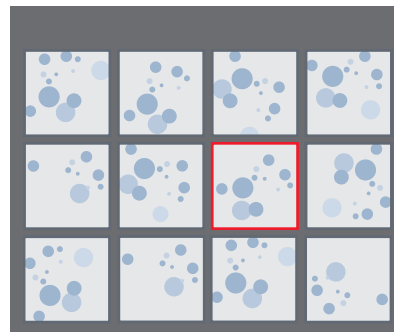







Thumbnail view

Calling up the Camera Menu

 The remote control can only work when the camera is in SD mode.





Opening and closing the camera menu

1. Point the remote control towards the camera.
2. Press the  key on the remote control to show the camera menus on the monitor.
3. Press the , ,  and  buttons to select a menu item.
4. Press the  button to confirm a menu item.
5. Press the  button again to hide the camera menus.



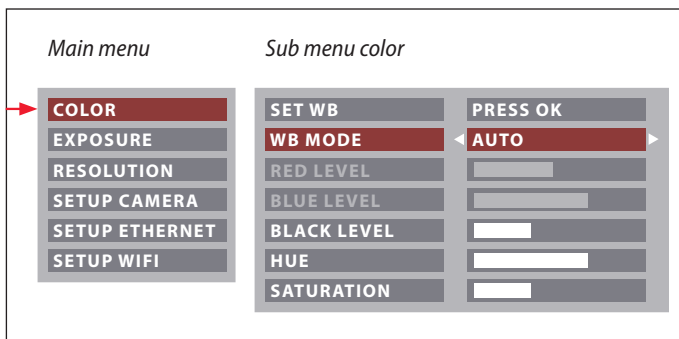

COLOR (Automatic White Balance)



 The "COLOR" function makes it possible to adapt the camera chip to the ambient light so that color-neutral images can be acquired.

Enabling automatic white balance

1. Press the  button on the remote control.
2. Call up the "COLOR" entry.
3. Set the value for "WB MODE" to "AUTO".
4. Press the  button to exit the menu.

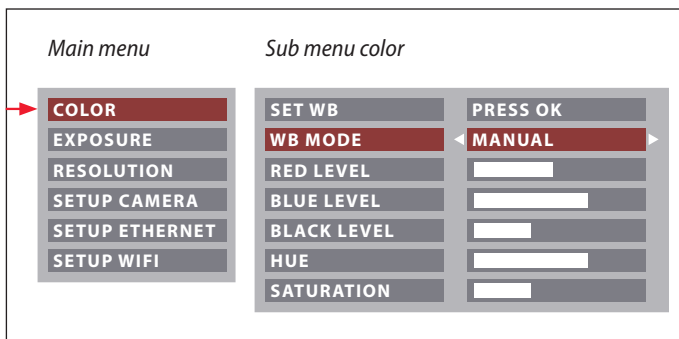

 The values for "RED" and "BLUE" cannot be adjusted if the "WB MODE" setting is set to "AUTO".

COLOR (Manual White Balance)



 The "COLOR" function makes it possible to adapt the camera chip to the ambient light so that color-neutral images can be acquired.

Adjusting the white balance manually (recommended)

1. Move the specimen out of the field of view so that only the illumination is seen.
2. Press the  button on the remote control.
3. Call up the "COLOR" entry.
4. Set the "WB MODE" to "MANUAL".
5. If necessary, correct the values for "RED" and "BLUE" until the image shows a uniform gray area.
6. Press the  button to exit the menu.

EXPOSURE

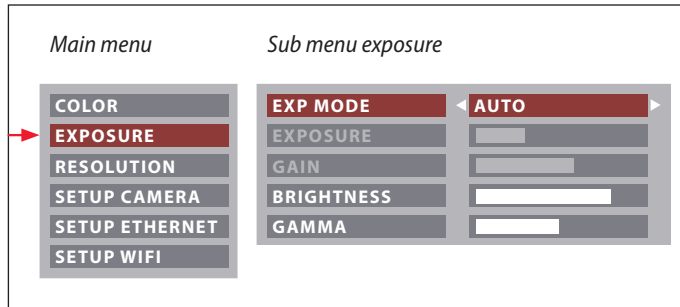

Automatic exposure

1. Press the  button on the remote control.
2. Call up the command for automatic exposure (see diagram at the left).
3. Set the value for "EXP MODE" to "AUTO".
4. Correct the values for "BRIGHTNESS" and "GAMMA" until you obtain the desired results for the image.

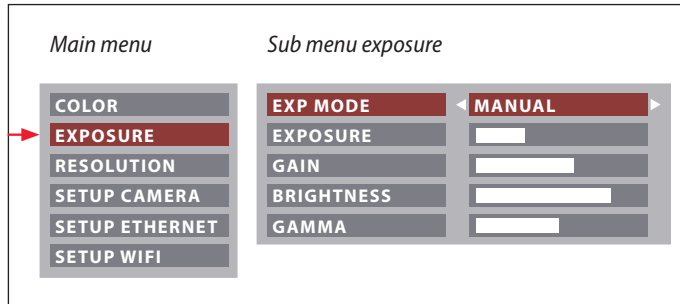

Manual exposure

1. Press the  button on the remote control.
2. Call up the command for manual exposure (see diagram at the left).
3. Set the value for "EXP MODE" to "MANUAL".
4. Correct the values for "EXPOSURE", "GAIN" and "GAMMA" until you obtain the desired results for the image.

RESOLUTION

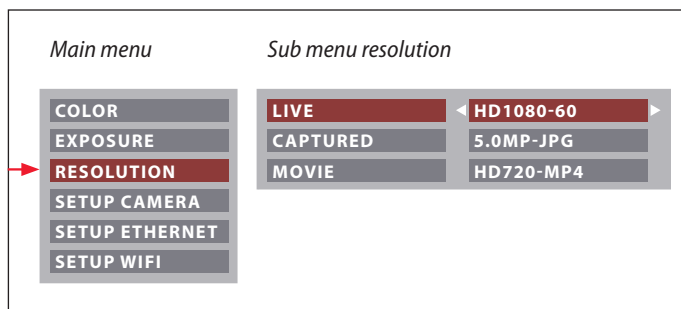

LIVE (resolution of the live image)

Defines the resolution of the live image.

CAPTURED (resolution of the captured image)

Defines the resolution of the captured image on the SD card.

MOVIE (resolution of videos)

Indicates the resolution of the captured videos on the SD card.



The "RESOLUTION" menu enables you to define the resolution for the live image, still image capture and video capture individually. This provides optimum results in every situation.

SETUP CAMERA (Camera Settings)

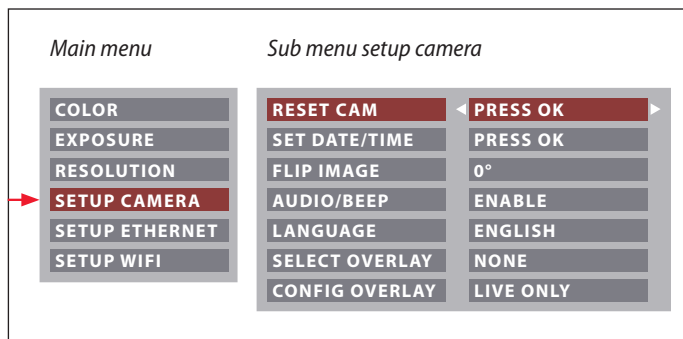

 The camera settings enable you to control internal parameters such as the date or time, reset the camera, etc.

RESET CAMERA

This command resets the camera to the factory settings. All user information (such as white balance, resolution etc.) is reset.

SET DATE TIME

This command sets the date and time as well as the format for displaying them. The following formats are available for selection: YYMMDD – DDMMYY – MMDDYY

FLIP IMAGE

Select to flip image 180°.



AUDIO/BEEP



You can decide to have a tone from the camera for some functions.

LANGUAGE

Select the language of the On Screen Display.

SELECTING IMAGE OVERLAYS (SELECT OVERLAY)

Press   to select another overlay. Press  to activate the selected overlay and leave the menu.

 If you want to quickly display other overlays, press when the live image is displayed   to show the next or previous respective overlay.

CONFIGURING IMAGE OVERLAYS (CONFIG OVERLAY)

Depending on the setting, this does not show an overlay, only shows the overlay in the live image or shows it in both the live image and the image capture.

SETUP ETHERNET

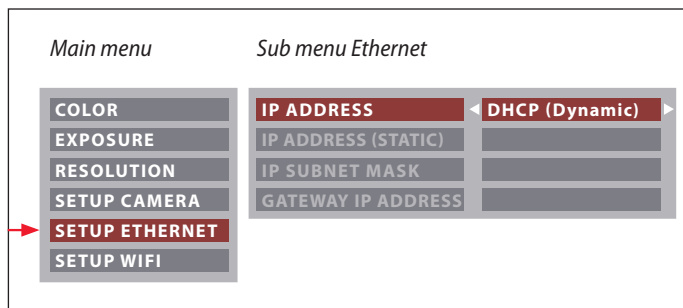

 This menu allows you to customize parameters relevant to working in Ethernet mode. Consult with your local IT expert for information relating to your local network.

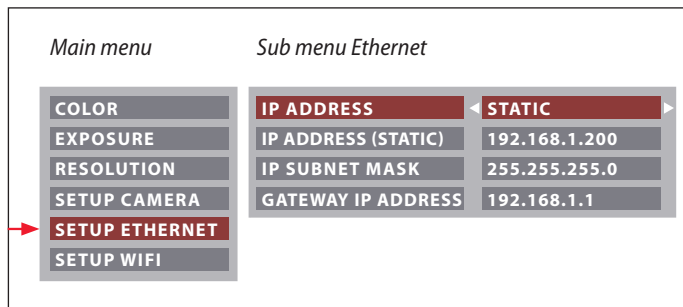

IP ADDRESS

You can decide if you want the IP address to be set by your network (Dynamic) or by you using the onscreen keyboard (Static).

If you selected "STATIC" for the IP address you can input the following using the onscreen keyboard:

- IP address
- IP subnet mask
- Gateway IP address

SETUP WiFi

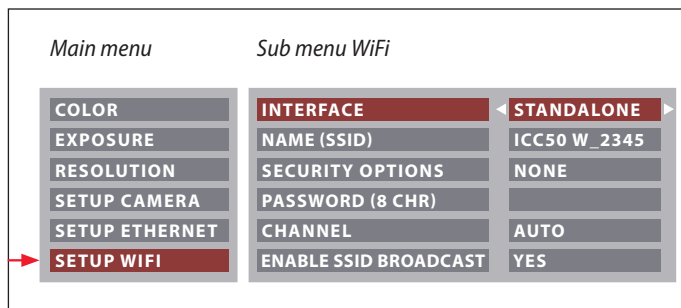

 This menu allows you to customize parameters relevant to working in WiFi mode.

INTERFACE – STAND ALONE

The camera is the access point.

INTERFACE – NETWORK

Your network provides the access point and the camera connects to your network by WiFi.

NAME (SSID)

This is the camera name which will appear. You can change the name using the onscreen keyboard.

SECURITY OPTIONS – NONE

This means there is no password.

SECURITY OPTIONS – WPA2-PSK AES

This allows you to create a password.

PASSWORD

Create a password using the onscreen keyboard.

CHANNEL

When stand alone is selected as the interface, this allows the WiFi channel to be set automatically or by the user.

ENABLE SSID BROADCAST

When stand alone is selected as the interface, you can decide if you want the camera name to be seen as available to connect.

WiFi PASSWORD: leicamicro

SETUP WiFi (Continued)

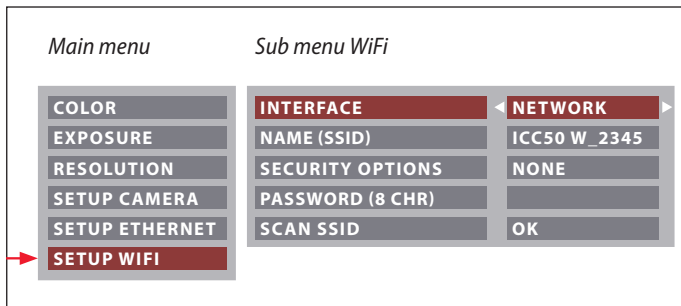



SCAN SSID

If "OK" is selected, you will see a list of WiFi access points nearby.

Pairing Cameras With Remotes

Pairing

 The Leica EZ4 W and the remote control can be paired and then only respond to each other. This can be helpful when using multiple cameras and remote controls.

1. Press the  button to start or end the process.

 In order to achieve successful pairing and avoid pairing by mistake, the second step must be performed within 4 seconds.

 If a "timeout" is displayed after 4 seconds, press the "Pair" button again to start the process.

2. Press and hold the button on your remote you want to define as the pairing button until a corresponding confirmation is displayed on the HD monitor. All of the buttons except the  button can be used for this.

3. The microscope only responds to the remote control commands from this remote control.

Resetting to factory setting

1. Press the button  to start the process.
2. Press the button  until a corresponding confirmation is displayed on the HD monitor.



Care, Transport, Contact Persons

Care, Transport, Contact Persons

General Instructions

- Keeping all optical components clean is important for maintaining good optical performance.
- Always protect the microscope and camera with the plastic cover when the instrument is not in use. (Included in the delivery package of the microscope.) Be sure power to the camera is off when the dust cover is in place.
- If any optical surface becomes badly coated with dust or dirt, it should be cleaned by blowing the surface with a syringe or brushing it off with a camel hair brush before attempting to wipe the surface clean.
- Optical surfaces should be cleaned using a lint-free cloth, lens cloth or cotton swab moistened with a commercially available glass cleaner. Do not use alcohol.
- Avoid excessive use of solvents. The lint-free cloth, lens cloth or cotton swab should be soaked with solvent, but not so wet that solvent runs over the lens.
- Protect the microscope from moisture, fumes and acids and from alkaline, caustic and corrosive materials. Do not store chemicals in the vicinity.
- Protect the microscope from oil and grease. Never grease or oil mechanical parts or sliding surfaces.
- It is advisable to enter a service agreement with Leica Service.

Transport



Always use both hands to carry the microscope. There is a handle on the back of the microscope and an undercut in the front for this purpose.

Contact address

If your instrument no longer works perfectly, contact your Leica representative. You can find information on worldwide Leica representatives on the Leica website: www.leica-microsystems.com.

Leica Microsystems (Switzerland) Ltd.
Max Schmidheiny Strasse 201
CH-9435 Heerbrugg (Switzerland)

Specifications

Due to the technology of the camera, the specifications are changing regularly. Please visit our website www.leica-microsystems.com/education for the latest brochure downloads to find the up to date specifications.

Specifications

Operating environment

| Feature | Specification |
|---|--|
| Temperature Operating Storage | +10°C to +40°C (50°F – 104°F) -20°C to +55°C (-4°F – 131°F) |
| Relative humidity (maximum) Operating/Storage | 10 % to 90 % (noncondensing) |
| Altitude (maximum) Operating Nonoperating | 0 m to 2,000 m (0 ft to 6,561 ft) 0 m to 10,668 m (0 ft to 35,000 ft) |
| Pollution Degree Rating | 2 |
| Weight | 4.6 kg |

Ports and connectors

| Feature | Specification |
|---------------------------|---|
| EZ4 W: USB | one standard USB 2.0 (Typ B) |
| EZ4 W: Video | one standard HDMI connector (Typ A) |
| EZ4 W: Network adapter | one RJ-45 connector |
| EZ4 W: Memory card reader | supports up to 32 GB |
| Integrated power supply | 100 V – 240 V ~ 50 / 60 Hz Automatic adjustment to local voltage |
| Power consumption | max. 30 W (EZ4 W), 15 W (ES2, EZ4) |

Dimensions

Leica ES2

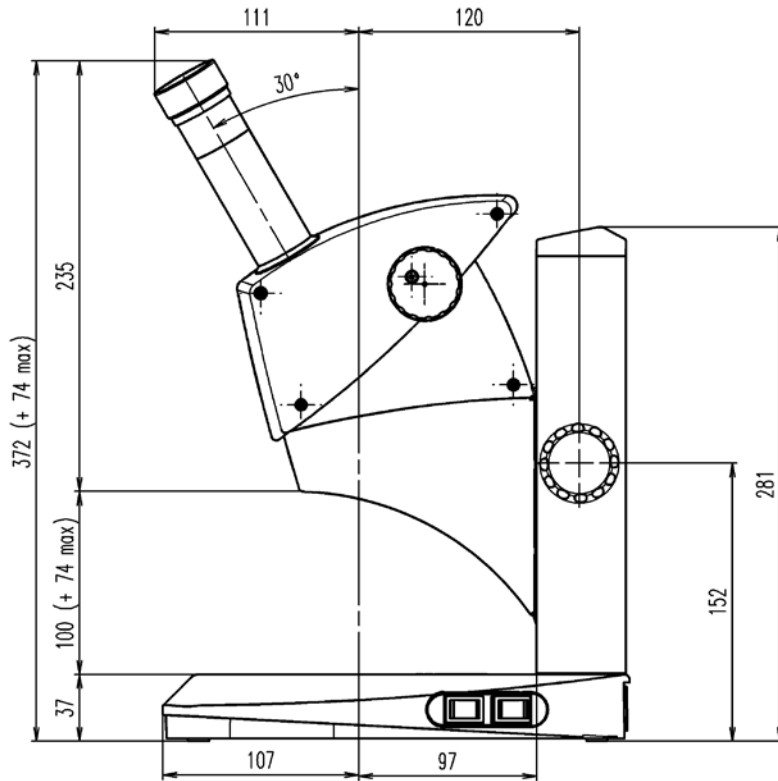

Leica ES2 (Continued)

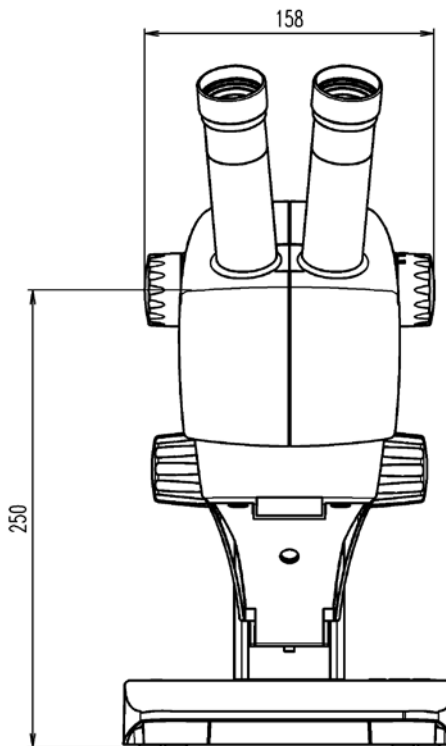
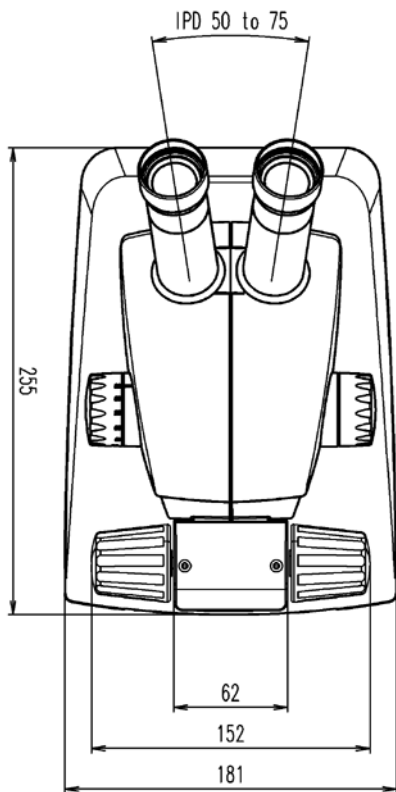

Leica EZ4 W

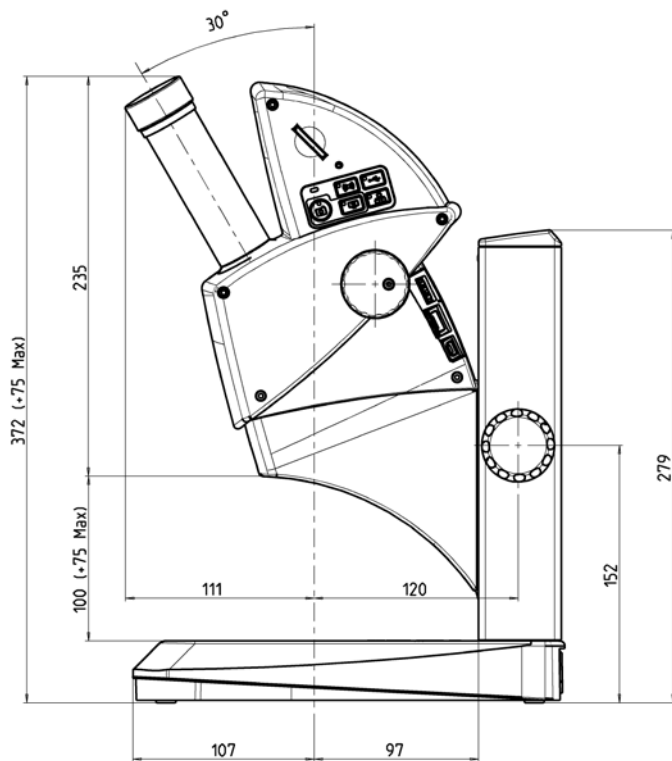

Leica EZ4 W (Continued)

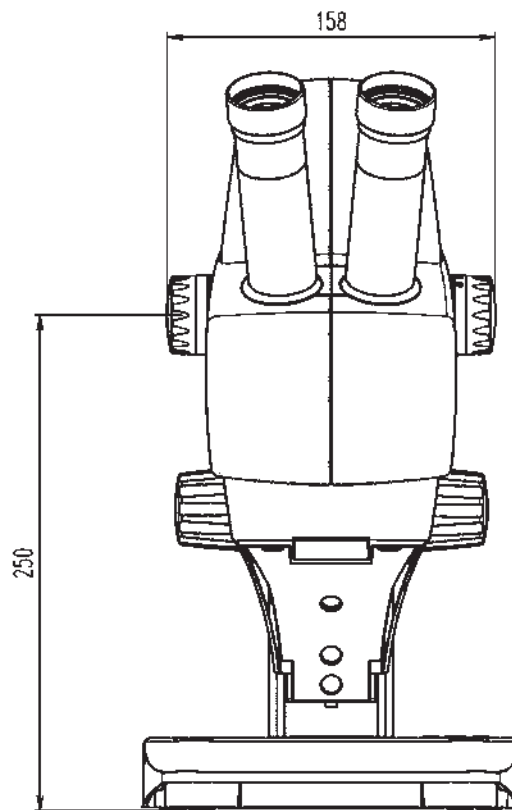
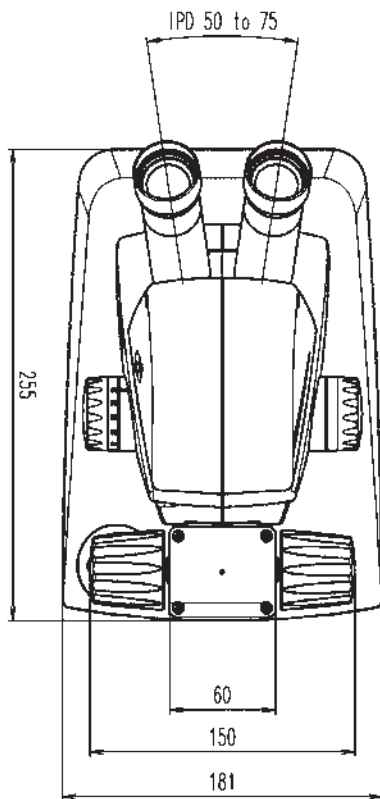

Leica EZ4, 10× Eyepieces

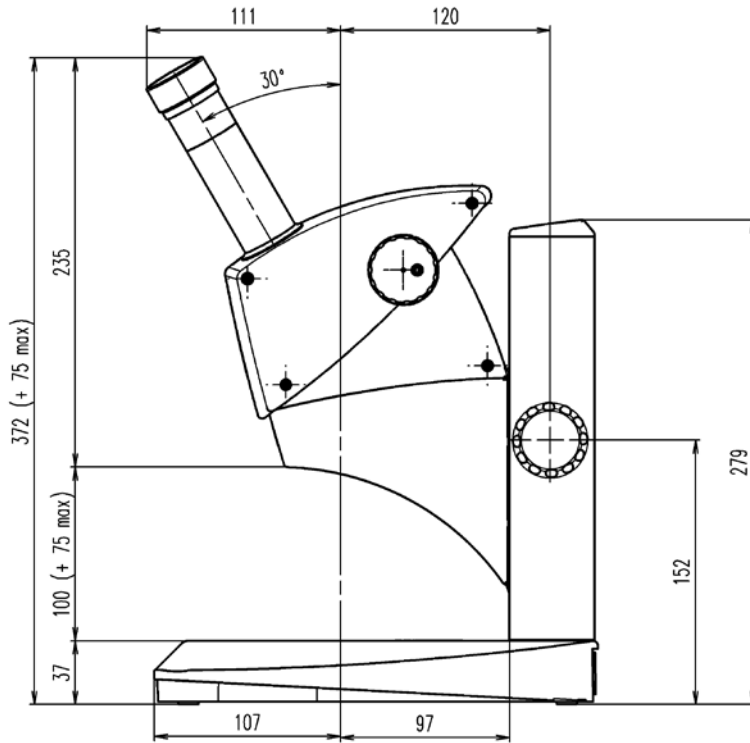

Leica EZ4, 10× Eyepieces (Continued)

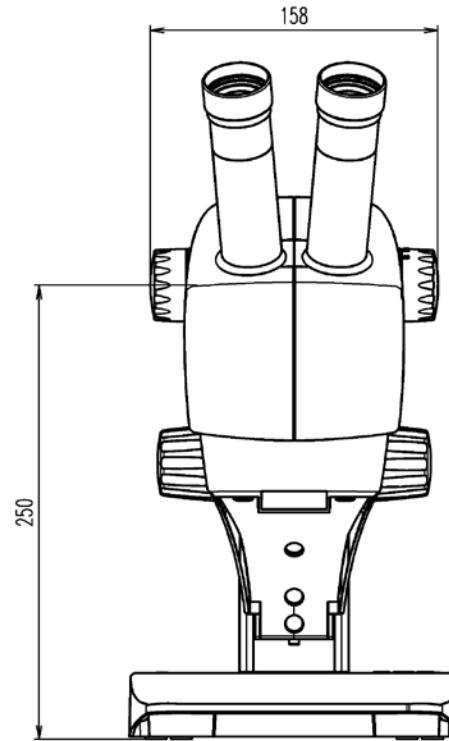
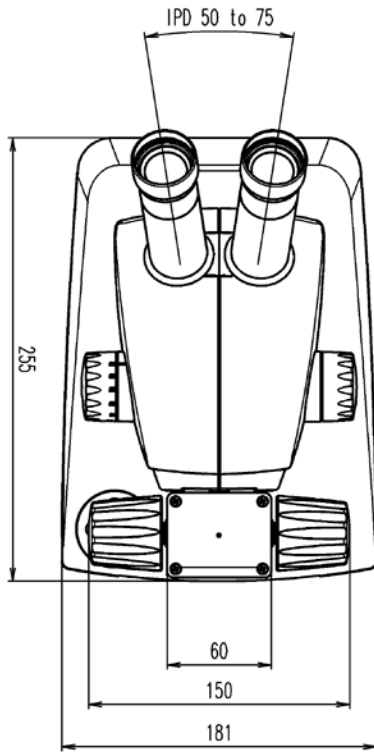

Leica EZ4 without Eyepieces

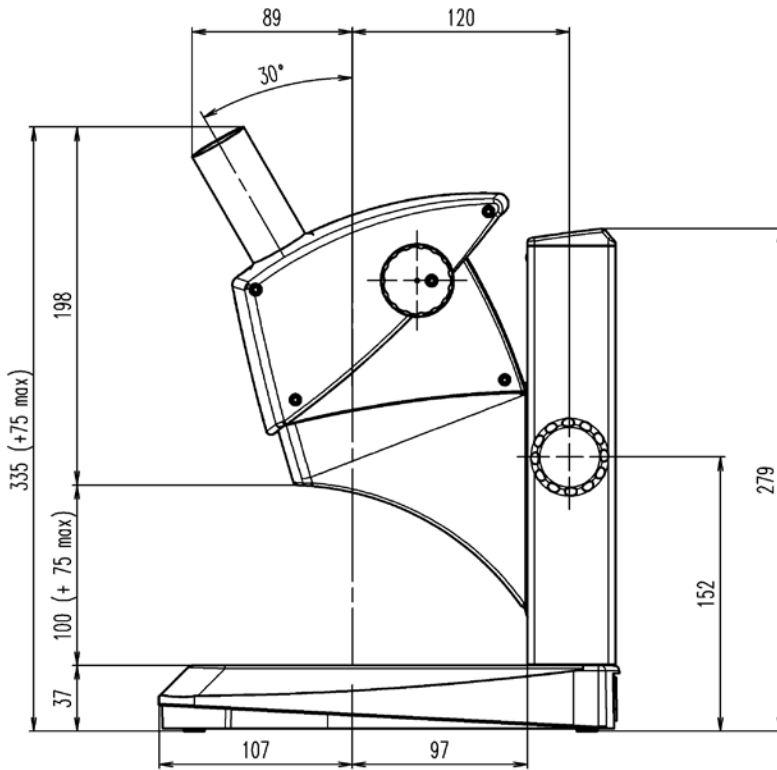

Leica EZ4, without Eyepieces (Continued)

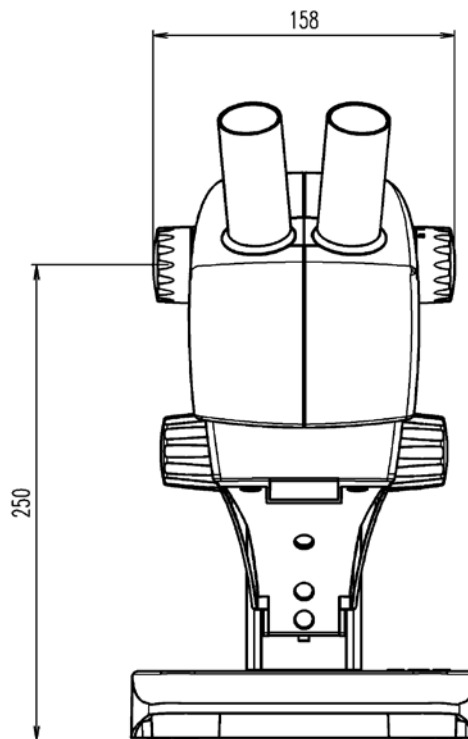
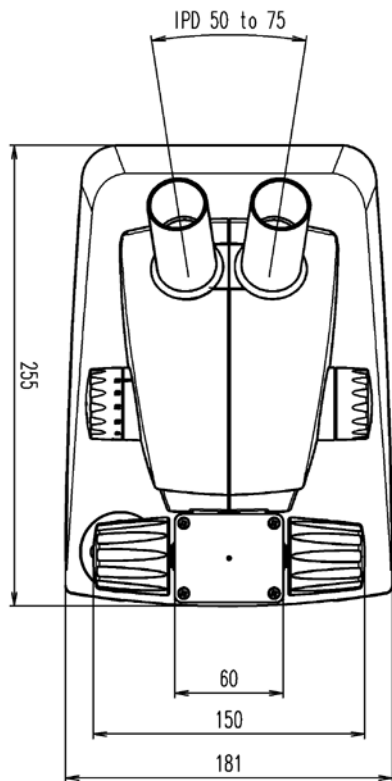

The statement by Ernst Leitz in 1907, “**With the User, For the User,**” describes the fruitful collaboration with end users and driving force of innovation at Leica Microsystems. We have developed five brand values to live up to this tradition: Pioneering, High-end Quality, Team Spirit, Dedication to Science, and Continuous Improvement. For us, living up to these values means: **Living up to Life.**

INDUSTRY DIVISION

The Leica Microsystems Industry Division’s focus is to support customers’ pursuit of the highest quality end result. Leica Microsystems provide the best and most innovative imaging systems to see, measure, and analyze the microstructures in routine and research industrial applications, materials science, quality control, forensic science investigation, and educational applications.

Leica Microsystems – an international company with a strong network of worldwide customer services:

| Active worldwide | Tel. | Fax |
|------------------------------------|--------------------|----------------|
| Australia · North Ryde | +61 2 8870 3500 | 2 9878 1055 |
| Austria · Vienna | +43 1 486 80 50 0 | 1 486 80 50 30 |
| Belgium · Diegem | +32 2 790 98 50 | 2 790 98 68 |
| Brazil · São Paulo | +55 11 2764-2411 | 11 2764-2400 |
| Canada · Concord/Ontario | +1 800 248 0123 | 847 405 0164 |
| Denmark · Ballerup | +45 4454 0101 | 4454 0111 |
| France · Nanterre Cedex | +33 811 000 664 | 1 56 05 23 23 |
| Germany · Wetzlar | +49 64 41 29 40 00 | 64 41 29 41 55 |
| India · Mumbai | +91 226 1880 200 | 226 1880 333 |
| Italy · Milan | +39 02 574 861 | 02 574 03392 |
| Japan · Tokyo | +81 3 5421 2800 | 3 5421 2896 |
| Korea · Seoul | +82 2 514 65 43 | 2 514 65 48 |
| Netherlands · Rijswijk | +31 70 4132 100 | 70 4132 109 |
| People’s Rep. of China · Hong Kong | +852 2564 6699 | 2564 4163 |
| · Shanghai | +86 21 6039 6000 | 21 6387 6698 |
| Portugal · Lisbon | +351 21 388 9112 | 21 385 4668 |
| Singapore | +65 6550 5999 | 6564 5955 |
| Spain · Barcelona | +34 93 494 95 30 | 93 494 95 32 |
| Sweden · Kista | +46 8 625 45 45 | 8 625 45 10 |
| Switzerland · Heerbrugg | +41 71 726 34 34 | 71 726 34 44 |
| United Kingdom · Milton Keynes | +44 800 298 2344 | 1908 577640 |
| USA · Buffalo Grove/Illinois | +1 800 248 0123 | 847 405 0164 |

13IDE10060EN_2 • Copyright © by Leica Microsystems (Schweiz) AG, CH-9435 Heerbrugg, 2015. Subject to modifications. LEICA and the Leica Logo are registered trademarks of Leica Microsystems IR GmbH.