

Com'X 510 Energy Server

User Manual

DOCA0098EN-05

10/2016

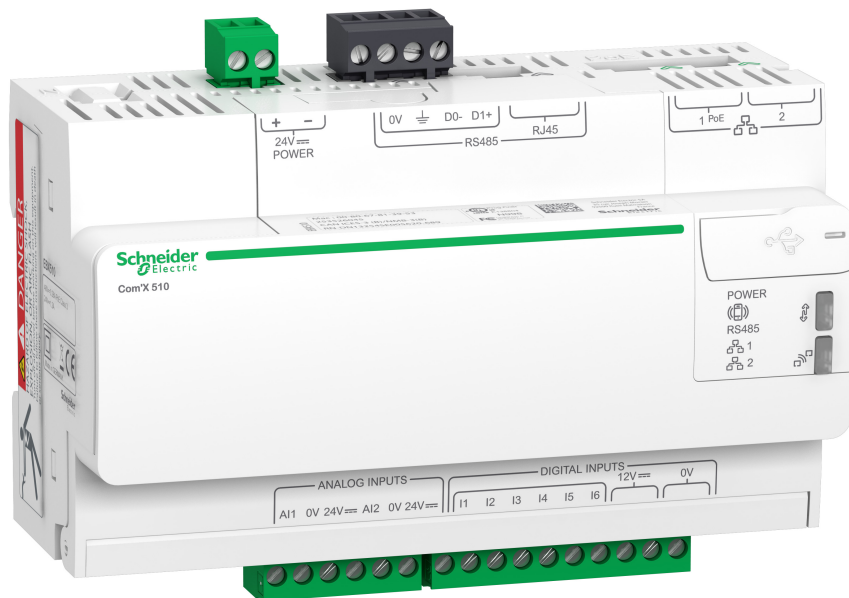

Safety Information

Important Information

Read these instructions carefully and look at the equipment to become familiar with the device before trying to install, operate, service or maintain it. The following special messages may appear throughout this bulletin or on the equipment to warn of potential hazards or to call attention to information that clarifies or simplifies a procedure.



The addition of either symbol to a "Danger" or "Warning" safety label indicates that an electrical hazard exists which will result in personal injury if the instructions are not followed.



This is the safety alert symbol. It is used to alert you to potential personal injury hazards. Obey all safety messages that follow this symbol to avoid possible injury or death.

DANGER

DANGER indicates a hazardous situation which, if not avoided, **will result in** death or serious injury.

WARNING

WARNING indicates a hazardous situation which, if not avoided, **could result in** death or serious injury.

CAUTION

CAUTION indicates a hazardous situation which, if not avoided, **could result in** minor or moderate injury.

NOTICE

NOTICE is used to address practices not related to physical injury.

Please Note

Electrical equipment should be installed, operated, serviced and maintained only by qualified personnel. No responsibility is assumed by Schneider Electric for any consequences arising out of the use of this material.

A qualified person is one who has skills and knowledge related to the construction, installation, and operation of electrical equipment and has received safety training to recognize and avoid the hazards involved.

Notices

FCC Part 15 Notice

This equipment has been tested and found to comply with the limits for a Class B digital device, pursuant to part 15 of the FCC Rules. These limits are designed to provide reasonable protection against harmful interference in a residential installation. This equipment generates, uses, and can radiate radio frequency energy and, if not installed and used in accordance with the instructions, may cause harmful interference to radio communications. However, there is no guarantee that interference will not occur in a particular installation. If this equipment does cause harmful interference to radio or television reception, which can be determined by turning the equipment off and on, the user is encouraged to try to correct the interference by one or more of the following measures.

- Reorient or relocate the receiving antenna.
- Increase the separation between the equipment and receiver.
- Connect the equipment to an outlet on a circuit different from that to which the receiver is connected.
- Consult the dealer or an experienced radio/TV technician for help.

This Class B digital apparatus complies with Canadian ICES-003.

Legal Information

The Schneider Electric brand and any registered trademarks of Schneider Electric Industries SAS referred to in this guide are the sole property of Schneider Electric SA and its subsidiaries. They may not be used for any purpose without the owner's permission, given in writing. This guide and its content are protected, within the meaning of the French intellectual property code (Code de la propriété intellectuelle français, referred to hereafter as "the Code"), under the laws of copyright covering texts, drawings and models, as well as by trademark law. You agree not to reproduce, other than for your own personal, noncommercial use as defined in the Code, all or part of this guide on any medium whatsoever without Schneider Electric's permission, given in writing. You also agree not to establish any hypertext links to this guide or its content. Schneider Electric does not grant any right or license for the personal and noncommercial use of the guide or its content, except for a non-exclusive license to consult it on an "as is" basis, at your own risk. All other rights are reserved.

Electrical equipment should be installed, operated, serviced and maintained only by qualified personnel. No responsibility is assumed by Schneider Electric for any consequences arising out of the use of this material.

As standards, specifications and designs change from time to time, please ask for confirmation of the information given in this publication.

Contents

Safety Information	3
Notices	4
Legal Information	5
Contents	6
Safety Precautions	11
Introduction	13
Architecture	13
Main Features	14
Com'X 510 for Entry-level Energy Management	14
Schneider Electric Digital Service Platform	15
Facility Insights	15
Power Monitoring Expert	15
Additional Resources	15
Access the Com'X 510 User Interface	17
Supported Web Browsers	17
Start Up Your Com'X 510	17
Reboot Cases	17
Accessing Through the Ethernet Port	18
Accessing Through Wi-Fi Access Point Mode	19
Logging In	20
Logging In for the First Time	21
Changing the Password	21
User Session Timeout	22
Com'X 510 User Interface Overview	22
Com'X 510 Features	24
Quickstart Guides for Com'X 510	27
Quickstart: Setting Up and Starting Data Logging	27
Quickstart: Viewing On-board Data	27
Quickstart: Setting Up Publication	28
Settings	29
General Settings	29
Date and Time Settings	29
Network Settings	30
Proxy Settings	39
Publication	41
Wi-Fi Access Point Settings	48
Site Settings	49
Site Information	49
Data Logging	50
Communication Settings	50
Modbus TCP Access	50
Modbus TCP/IP Filtering	53
Modbus Serial Port	53
Advanced Ethernet Settings	55
ZigBee Network Settings	56
Security	58
Firewall Management	59

Certificates	60
User Management	61
Group Settings	61
Users	63
Events	65
Predefined Events	65
Custom Events	65
Creating a Custom Event	66
Editing or Deleting a Custom Event	68
Copying an Event	68
Links	68
Configuring Links	68
Viewing Links	69
Custom Page Management	69
Adding a Custom Web Page	69
Deleting Custom Web Pages	70
Downloading a Custom Page	70
Viewing a Custom Web Page	70
Device Settings	73
Device Settings Overview	73
Common Properties	75
General Properties	76
Monitored Area	76
Manage Devices	78
Adding a Downstream Device	78
Modifying a Device	79
Disconnecting a Device	79
Reconnecting a Device	80
Replacing a Device	80
Deleting a Device	81
Measurement and Metadata Exported Per Hosted Platform	81
Selecting Measurements to Log or Publish	82
Devices That Can Connect to Digital Inputs	83
Built-In Pulse Meters	83
Custom Pulse Meter	84
Devices That Can Connect to Analog Inputs	84
Resistance Temperature Detectors	85
Custom Analog Devices	85
Modbus Devices	85
Discovering Connected Devices	85
Adding a Modbus Device Manually	87
Connecting Devices to WT4200 Modbus Receiver	88
Connecting Devices to Acti 9 Smartlink	89
Ethernet Devices	90
Built-in Ethernet Devices	90
Ethernet Device Configuration Parameters	90
Custom Ethernet Devices	91
ZigBee Device Discovery	91
Discovering Devices	91
Measurements Table	93
Viewing the Measurements Table	93
Commissioning	95

Commissioning Interface	95
Starting the Data Logging	96
Starting the Publication	97
Monitoring	99
Real Time Data	99
Single Device View	99
Summary Device View	100
Real Time Trending	101
Dashboards	102
Viewing a Dashboard Graph or Table	102
Saving Dashboard Data Points or Graph	103
Saving a Dashboard Link	103
Using the Dashboard Kiosk	104
Historical Data Export	104
Exporting Historical Data	104
Custom Web Pages	105
Control	107
Device Resets	107
Resetting Device Parameters	107
Setting Time on Devices	107
Diagnostics	109
Statistics	109
Viewing Statistics	109
Resetting Statistics	109
Interpreting Statistics	109
Read Device Registers	112
Reading Device Registers	113
Communications Check	113
Executing a Manual Communications Check	113
Defining the Out of Service Time	114
Custom Library	115
Custom Models	115
Creating a Custom Model	115
Custom Modbus Devices	116
Creating a Modbus Custom Slave	116
Defining a Modbus Custom Slave	117
Modbus Custom Slave Register Examples	118
Creating a Modbus Frame	118
Creating Modbus Variables	119
Adding a Custom Modbus Device	121
Custom Pulse Meter Model	122
Creating a Custom Pulse Meter	122
Custom KYZ Pulse Meter Model	124
Custom Main Meter Model	125
Creating a Custom Main Meter	125
Main Meter Measure and Signal Properties	126
Adding a Custom Main Meter	128
Connecting a Standard Main Meter	129
Custom Contactor or Impulse Relay	130
Creating a Custom Contactor or Impulse Relay	130
Creating a Custom Analog Sensor Model	131
Creating a Custom Analog Sensor	132

Working with Custom Models	134
Modifying a Custom Model	134
Deleting a Custom Model	135
Exporting One or More Custom Models	135
Importing One or More Custom Models	135
Maintenance	137
Logs	137
System Settings	138
Save the Configuration	138
Restore the Configuration	140
Upgrade Firmware	143
Enabling Remote Access	144
Restarting the Com'X 510 from the Web Interface	145
Com'X 510 Replacement	145
Resets	145
Resetting the Password Locally	145
Resetting to Factory Settings	146
Checklist Before Leaving Customer Site	147
Troubleshooting	149
Metering Device Troubleshooting	149
Digital Input Troubleshooting	149
Analog Input Troubleshooting	149
Modbus Device Troubleshooting	150
Network Troubleshooting	151
Ethernet Troubleshooting	151
GPRS/3G Troubleshooting	152
Wi-Fi Troubleshooting	152
Com'X 510 Troubleshooting	152
Com'X 510 Access	152
Web Pages	153
Digital Service Platform Selection	153
Data Publishing	153
Firmware Upgrade	154
Events	154
Appendices	155
Appendix A: Publish Data to Energy Operation	156
Quick Start Overview	156
Define the Initial and Site Settings	158
Define the Network Settings to Publish Data	160
Define the Metering Devices	161
Visualize the Data to Publish	166
Publishing the Data to Energy Operation	166
Appendix B: Replacing the SD Card	168
Appendix C: List of Supported Devices	169
Appendix D: List of Certificate Authorities	170
Appendix E: IPv4 Address Settings	176
Static IP Settings	176
DHCP Client	176
DHCP Server Over Ethernet Port	177
DHCP Server Over Wi-Fi	177
Remote Access with Windows Operating Systems	178
Appendix F: Modbus Register Mapping	179

Discovery Feature	179
Com'X 510 Register Mapping	179
EM4300 Register Mapping	181
Index	185

Safety Precautions

DANGER

HAZARD OF ELECTRIC SHOCK, EXPLOSION, OR ARC FLASH

- Apply appropriate personal protective equipment (PPE) and follow safe electrical work practices. See NFPA 70E in the USA, CSA Z462 or applicable local standards.
- Turn off all power supplying this device and the equipment in which it is installed before working on the device or equipment.
- Always use a properly rated voltage sensing device to confirm that all power is off.
- Treat communications and I/O wiring connected to multiple devices as hazardous live until determined otherwise.
- Do not exceed the device's ratings for maximum limits.
- Replace all devices, doors and covers before turning on power to this equipment.

Failure to follow these instructions will result in death or serious injury.

WARNING

UNINTENDED EQUIPMENT OPERATION

- Do not use the software for critical control or protection applications where human or equipment safety relies on the operation of the control action.
- Do not use the software to control time-critical functions because communication delays can occur between the time a control is initiated and when that action is applied.
- Do not use the software to control remote equipment without securing it with an authorized access level, and without including a status object to provide feedback about the status of the control operation.

Failure to follow these instructions can result in death, serious injury, or equipment damage.

⚠ WARNING**INACCURATE DATA RESULTS**

- Do not incorrectly configure the software, as this can lead to inaccurate reports and/or data results.
- Do not base your maintenance or service actions solely on messages and information displayed by the software.
- Do not rely solely on data displayed in the software reports to determine if the system is functioning correctly or meeting all applicable standards and requirements.
- Do not use data displayed in the software as a substitute for proper workplace practices or equipment maintenance.

Failure to follow these instructions can result in death, serious injury, equipment damage, or permanent loss of data.

Introduction

The Com'X 510 energy server is a compact plug and play gateway and data logger and is an essential part of an entry level energy management system. It collects and stores consumption of WAGES (Water, Air, Gas, Electricity, and Steam) and environmental parameters such as temperature, humidity, and CO² levels in a building. The Com'X 510 provides access to reports such as on-board device and circuit summary pages, as well as on-board data logging. Data can be securely accessed in real time or transmitted as a report to an Internet database server.

Data is ready to be processed once received by the server. Data is displayed as web pages through energy management services provided by Schneider Electric, such as StruxureWare Energy Operation and Facility Insights, to support optimization of energy performance and cost management.

Architecture

This graphic shows possible architectures of the Com'X 510:

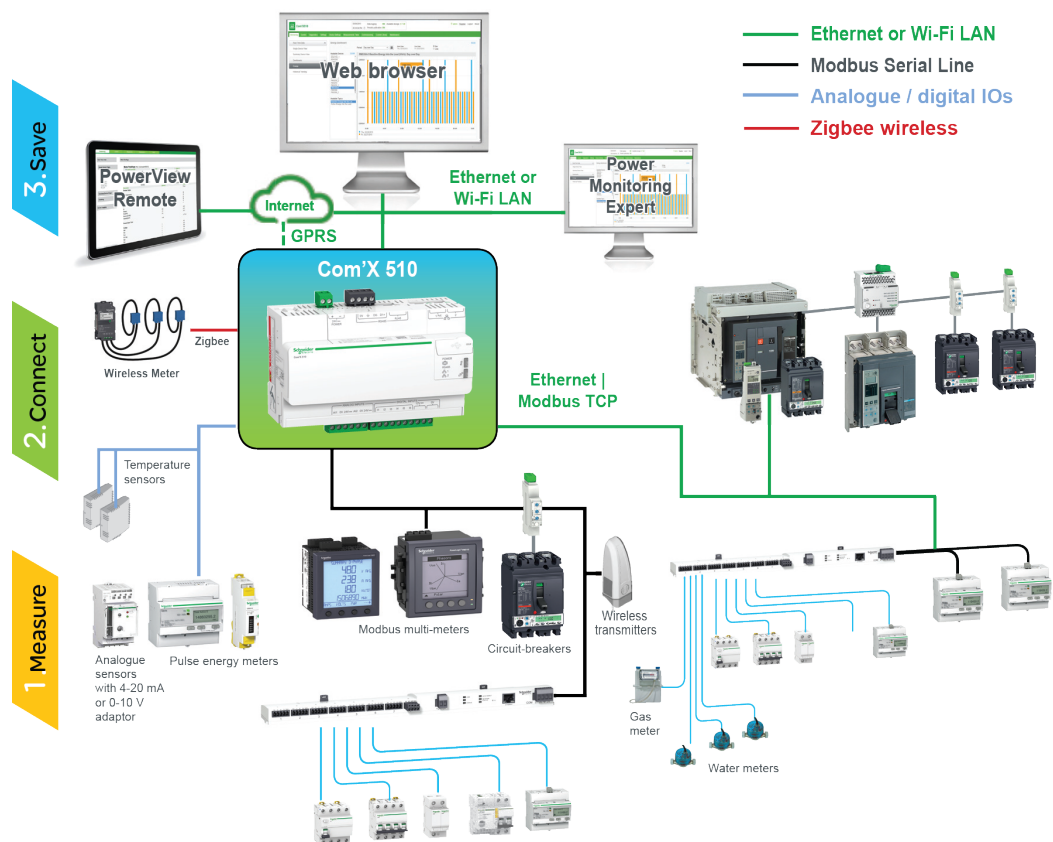

From a simple metering installation with one device to large metering systems, the Com'X 510 collects data from any Modbus TCP/Modbus serial line gateways, pulse meters, actuators, and analog sensors.

Main Features

The main features of the Com'X 510 are:

- real-time data in easy to understand views
- dashboard view for historical reporting
- automatic discovery of connected Modbus devices
- connectivity to the cloud through three media: GPRS/3G, wired Ethernet, or Wi-Fi Ethernet
- two Ethernet ports to separate upstream cloud connection from field device network
- four supported transfer protocols: HTTP, HTTPS, FTP, and SMTP with proxy management
- data logging
- data export with native connection to Schneider Electric service platforms (such as Energy Operation) and with .csv file for other database servers
- gateway functionality Modbus TCP to Modbus RTU or Modbus ASCII
- setup through on-board web pages
- compliant with electrical switchboard environment (temperature, electromagnetic compatibility)
- local backup of configuration parameters
- ZigBee Pro with EM4300 sensors

Com'X 510 for Entry-level Energy Management

The Com'X 510 supports real-time data views from many common device types, providing several device-specific features. Additional energy management capabilities include:

- View real-time and historical information from multiple locations through a supported web browser.
- Select the logging intervals and topics you want logged.
- Automatically export selected logged data to your PC for additional analysis.
- Provide data and system security through password protection and controlled access to individual web pages, as well as through Com'X 510 firewall management.
- Perform simple control reset commands for supported devices (for example, min/max and accumulated energy).
- Set date and time for connected devices that support set time commands.

Schneider Electric Digital Service Platform

The energy server Com'X 510 can be associated with Schneider Electric Digital Service Platform. This platform allows you to:

- Remotely manage firmware upgrade, configuration backup on the cloud, troubleshooting, and parameter settings.
- Provide a SIM card with worldwide coverage, by using the EBXA-GRPS-SIM option.
- Publish collected data to Schneider Electric energy management services.

Facility Insights

Facility Insights allows you to outsource energy management and maintenance, reducing your energy costs and increasing operating efficiency in buildings.

Facility Insights is a cloud-based software application from Schneider Electric to improve energy efficiency, and manage assets and maintenance. Facility Insights is used for small and medium buildings in industry, retail, public, and healthcare markets.

Facility Insights provides the following features:

- Support for data acquisition hardware: meters, gateways, and sensors.
- Cloud platform for data displays.
- Consulting service from Schneider Electric expert teams.
- A network of local partners to implement solutions.

Power Monitoring Expert

The Com'X 510 can send data in comma-separated value (CSV) files to supervision software such as Power Monitoring Expert (PME) or third-party supervision software.

PME is a complete, interoperable, and scalable software package for power management applications. The software collects and organizes data gathered from the electrical network and presents it as meaningful, actionable information through an intuitive Web interface. Share information with key stakeholders or across your entire operation to influence behavioral changes that can save you money.

Additional Resources

Document	Reference Number(s)
Com'X 510 Instruction Sheet	5406AD002 5406AD005 5406AD006
EBXA-GPRS/EBXA-GPRS-SIM Instruction Sheet	253537613

Document	Reference Number(s)
EBXA-WIFI Instruction Sheet	253537634
Metering and Data Acquisition System, Installation Guide (Chinese, English, French, Italian, Spanish)	DOCA0035ZH DOCA0035EN DOCA0035FR DOCA0035IT DOCA0035ES
Zigbee Instruction Sheet	NHA2243500

To find these and other resources, go to www.schneider-electric.com and search for “Com'X 510.”

Access the Com'X 510 User Interface

Supported Web Browsers

Browser	Browser Version
Internet Explorer	IE9 and above
Firefox	20.0 and above
Chrome	24.0 and above

Recommended Web Browsers

We recommend using Chrome for PC.

The following browsers are recommended for tablets:

Operating System	Browser
Windows 8	<ul style="list-style-type: none"> • Internet Explorer • Firefox
iOS	<ul style="list-style-type: none"> • Chrome • Safari
Android	<ul style="list-style-type: none"> • Chrome • Android browser

Start Up Your Com'X 510

The Com'X 510 takes time to start up. Wait for the power LED to turn green before performing any actions.

Once the Com'X 510 is started, most configuration modifications are taken in account without a reboot.

However, there are some actions that require rebooting the Com'X 510.

Reboot Cases

The Com'X 510 requires a reboot in the following cases:

- Upgrading the firmware.
- Restoring a configuration.
- Changing the Ethernet network settings between 2 switched ports and 2 separate ports.

- Inserting a GPRS or 3G modem.
- Installing a Zigbee key.

Accessing Through the Ethernet Port

⚠ DANGER

HAZARD OF ELECTRIC SHOCK, EXPLOSION, OR ARC FLASH

- This equipment must only be installed and serviced by qualified personnel.
- Apply appropriate personal protective equipment (PPE) and follow safe electrical work practices. See NFPA 70E in the USA, CSA Z462 or applicable local standards.

Failure to follow these instructions will result in death or serious injury.

Follow one of the procedures below to access the Com'X 510 user interface for initial setup.

With Windows 7/Vista

1. Disconnect your local computer from all networks.
2. Connect an Ethernet cable from your local computer to the Ethernet port 2 of the Com'X 510.
3. Open **Windows Explorer** on your local computer and click **Network**.

The Com'X 510 appears in the list of devices. Refer to [Troubleshooting on page 149](#) if the Com'X 510 does not appear.

4. Double-click the Com'X 510. The login page is opened automatically on your default web browser.

NOTE: HTTPS is enabled by default on the Com'X 510 configuration. The Com'X 510 has an autosigned security certificate. Therefore, connecting to the Com'X 510 interface displays a security message. Before accepting, confirm that communication with the Com'X 510 has been established. To install a new certificate, see [Security on page 58](#).

5. Type the username (default: *admin*) and the password (default: *admin*).

NOTE: The username and password are case-sensitive.

6. Click **Ok**.

With Other Operating Systems

1. Disconnect your local computer from all networks.
2. Connect an Ethernet cable from your local computer to the Ethernet port 2 of the Com'X 510.
3. Open your web browser.
4. Type **[10.25.1.1]** in the address field and press **Enter**.

NOTE: HTTPS is enabled by default on the Com'X 510 configuration. The Com'X 510 has an autosigned security certificate. Therefore, connecting to the Com'X 510 interface displays a security message. Before accepting, confirm that communication with the Com'X 510 has been established. To install a new certificate, see [Security on page 58](#).

5. Type the username (default: *admin*) and the password (default: *admin*).

NOTE: The username and password are case-sensitive.

6. Click **Ok**.

Accessing Through Wi-Fi Access Point Mode

 DANGER
<p>HAZARD OF ELECTRIC SHOCK, EXPLOSION, OR ARC FLASH</p> <ul style="list-style-type: none">• This equipment must only be installed and serviced by qualified personnel.• Apply appropriate personal protective equipment (PPE) and follow safe electrical work practices. See NFPA 70E in the USA, CSA Z462 or applicable local standards. <p>Failure to follow these instructions will result in death or serious injury.</p>

NOTICE
<p>UNINTENDED EQUIPMENT OPERATION</p> <p>Do not close the door of a metallic enclosure while using the Wi-Fi USB key.</p> <p>Failure to follow these instructions can result in equipment damage.</p>

Follow one of the procedures below to access the Com'X 510 user interface.

With Windows 7/Vista

1. Connect the Wi-Fi USB key to a USB port on the Com'X 510.
2. Press the Wi-Fi button on the Com'X 510. The Wi-Fi button LED flashes green.
3. On your local computer, connect to the Com'X 510 wireless network using the **Windows Wireless Network configuration** window.
4. Open **Windows Explorer** on your local computer and click **Network**. The Com'X 510 appears in the list of devices. Refer to [Troubleshooting on page 149](#) if the Com'X 510 does not appear.
5. Double-click the Com'X 510 and the login page opens automatically in your default browser.

NOTE: HTTPS is enabled by default on the Com'X 510 configuration. The Com'X 510 has an autosigned security certificate. Therefore, connecting to the Com'X 510 interface displays a security message. Before accepting, confirm that communication with the Com'X 510 has been established. To install a new certificate, see [Security on page 58](#).

6. Type the username (default: *admin*) and the password (default: *admin*).

NOTE: The username and password are case-sensitive.

7. Click **Ok**.

With Other Operating Systems

1. Connect the Wi-Fi USB key to a USB port on the Com'X 510.
2. Press the Wi-Fi button on the Com'X 510. The Wi-Fi button LED flashes green.
3. On your local computer, connect to the Com'X 510 wireless network using the **Windows Wireless Network configuration** window.
4. Open your browser.
5. Type **[10.25.2.1]** in the address field and press **Enter**.

NOTE: HTTPS is enabled by default on the Com'X 510 configuration. The Com'X 510 has an autosigned security certificate. Therefore, connecting to the Com'X 510 interface displays a security message. Before accepting, confirm that communication with the Com'X 510 has been established. To install a new certificate, see [Security on page 58](#).

6. Type the username (default: *admin*) and the password (default: *admin*).

NOTE: The username and password are case-sensitive.

7. Click **Ok**.

Logging In

If multiple sessions are opened, only the first session can be used to edit parameters. Sessions opened after the first session are read-only.

To log in to the user interface:

1. Select your language.
2. Type the username and the password.

NOTE: The username and password are case-sensitive.

3. Click **Connect** to be logged in to the configuration web page.

NOTE: HTTPS is enabled by default on the Com'X 510 configuration. The Com'X 510 has an autosigned security certificate. Therefore, connecting to the Com'X 510 interface displays a security message. Before accepting, confirm that communication with the Com'X 510 has been established. To install a new certificate, see [Security on page 58](#).

Logging In for the First Time

The web server is a tool for reading and writing data. It controls the state of the system, with full access to all data in your application. You will be prompted to change your password the first time you log in to prevent unauthorized access to the application.

NOTICE

UNAUTHORIZED DATA ACCESS

- Immediately change the default password to a new, secure password.
- Do not distribute the password to unauthorized or otherwise unqualified personnel.

Failure to follow these instructions can result in equipment damage.

NOTE: A secure password should not be shared or distributed to unauthorized personnel. The password should not contain any personal or obvious information.

Follow these instructions to log in to the user interface for the first time:

1. Log in using the default password.
2. Read the **License Agreement** completely.

NOTE: The **Accept** button will remain grayed until you scroll to the bottom of the User License Agreement.

3. Accept the **License Agreement**.
4. Enter a new password. It must contain:
 - 8 characters
 - 1 uppercase letter
 - 1 numeric digit
 - 1 special character

Changing the Password

To change the password after the first login:

1. Click the username/admin link  in the banner.
2. Enter the current password.
3. Enter a new password.
4. Confirm the new password.
5. Click **OK**.

NOTE: An administrator cannot modify the username or password after the user is created. If you forget your username or password, contact an administrator to delete the account and create a new one.

User Session Timeout

The login session terminates after the configured **Session Inactivity Time-out** interval for the user group (see [Group Settings](#) on page 61).

Com'X 510 User Interface Overview

This graphic shows the interface layout:

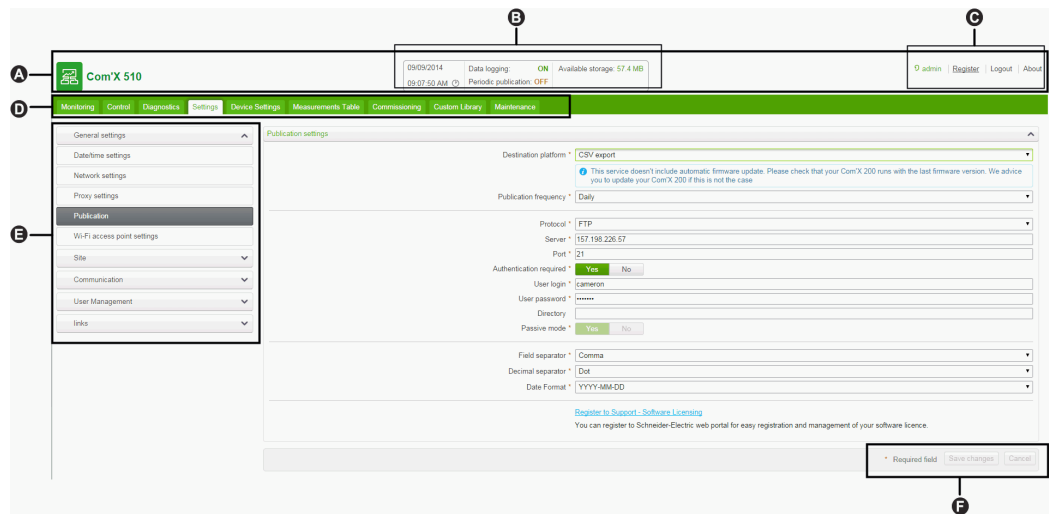

A	Banner
B	Com'X 510 status
C	Generic information
D	Main tabs
E	Subtabs
F	Action buttons

Banner

The banner displays the following information at the top of all pages:

Com'X 510 Status	Data Logging: Displays status of data logging, which can be activated in the Commissioning tab.
	Periodic Publication: Displays publication status, which can be activated in the Commissioning tab.
	Available Storage: Shows available storage for data logging.
Generic Information	Username/admin link: Displays the connected user.
	About: Click to access information on your Com'X 510 and GPRS or 3G modem (serial number and MAC address), IPv4 Ethernet ports, IPv6 address, and software versions.
	Logout: To log out of the session, click Logout or close your browser. It is recommended to log out of the Com'X 510 when not in use.
	Time: Displays the time as set in the Date/Time Settings (see Configuring Date and Time Settings on page 159).

Main Tabs and Subtabs

See [Com'X 510 Features on page 24](#) for a list of main tabs and subtabs.



Subtabs display the submenus under the selected main tab. You can bookmark each subtab of the Com'X 510 web interface.

Action Buttons

The action buttons correspond to the selected tab and vary. This table describes the interface buttons:

Button	Action
Save changes	Validates the modifications. Disabled when: <ul style="list-style-type: none"> there is no change in the web page. a mandatory field is left blank. The field is highlighted in red. inappropriate characters are entered in a field. The field is highlighted in red.
Cancel	Cancel the modifications to return to the last saved settings.

Icons

Icon	Description
	Indicates that the information necessary to complete the Com'X 510 configuration and activation of data logging and publication is unavailable for the tab.
*	Fields marked with a red star are required fields.
	Indicates the user that is logged in for the current session.

Icon	Description
	Contains information about configuration in the open menu.

Com'X 510 Features

The main tabs and subtabs are described below:

Main Tab	Subtab	Description
Settings	General Settings	Configures the date and time, network settings, proxy settings, publication parameters, and Wi-Fi access point settings.
	Site Settings	<ul style="list-style-type: none"> Contains the name of the site. This field is used by Energy Operation. Configures the logging interval for each commodity and for environmental parameters.
	Communication	Configures the Modbus serial port, Modbus gateway, TCP/IP filtering, and advanced Ethernet settings. Setup and create a ZigBee network.
	Security	Update SSL certificate and firewall settings.
	User Management	Create and edit groups and users.
	Links	Configure file and URL documentation links.
Device Settings	–	Configures the metering architecture and the data to log and publish.
Measurements Table	–	Displays meters with metadata and data to be logged.
Commissioning	–	<ul style="list-style-type: none"> Checks the system configuration. Starts or stops data logging. Starts, stops, or tests data publication.
Monitoring	Real Time Data	Provides basic readings of selected devices. Features include single device and summary views.
	Dashboards	Provides graphical representation of energy consumption information aggregated over time for devices enabled for data logging and provides trending information for other electrical properties.
Control	Device Resets	Allows execution of resets defined for the device, and displays the date and time each reset function was performed.
	Set Device Time	Date and time resets are shown only when the device supports them.

Main Tab	Subtab	Description
Diagnostics	Statistics	Displays diagnostic data used to troubleshoot network problems.
	Read Device Registers	Allows users to read register data from local and remote Modbus devices connected to the Com'X 510.
	Communications Check	Tests the communications health of Modbus devices configured on the Com'X 510.
Custom Library	–	<ul style="list-style-type: none"> • Create a custom device model, new device model or based on an existing custom device model in the library. • Modify and delete custom models • Import and export custom models.
Maintenance	Logs	Shows the date, time, and description of: <ul style="list-style-type: none"> • changes in the configuration • errors detected during logging • publication steps and status • communication interruption with metering devices • unsuccessful login attempts
	System Settings	<ul style="list-style-type: none"> • Allows you to back up and restore a Com'X 510 configuration. • Activates the remote access for Schneider Electric technical support. • Upgrades the Com'X 510 firmware. • Allows you to manually restart the Com'X 510.

Quickstart Guides for Com'X 510

This chapter describes how to perform common tasks with the Com'X 510. For a full description of the feature outlined in each, see the chapter to which it points.

Quickstart: Setting Up and Starting Data Logging

Below are the general tasks related to starting data logging. There may be additional steps for publishing to a specific platform.

1. Add the downstream devices as in [Adding a Downstream Device on page 78](#). There are additional configuration tasks for each type of device:
 - [Adding a Digital Input on page 161](#)
 - [Adding an Analog Input on page 163](#)
 - [Adding a Schneider Electric Modbus Serial Device on page 164](#)
 - [Ethernet Device Configuration Parameters on page 90](#)
2. Select the measurements to log as in [Selecting Measurements to Log or Publish on page 82](#)
3. Define the logging intervals as in [Defining the Logging Intervals on page 50](#)
4. Start the data logging as in [Starting the Data Logging on page 96](#).

Quickstart: Viewing On-board Data

You can view real time and logged data on the Com'X 510 without having to connect to a hosted platform. Below are the steps for viewing on-board data.

1. Add the downstream devices as in [Adding a Downstream Device on page 78](#). There are additional configuration tasks for each type of device:
 - [Adding a Schneider Electric Modbus Serial Device on page 164](#)
 - [Ethernet Device Configuration Parameters on page 90](#)
2. Complete the following steps to view an **Energy** dashboard or **Historical Trending**. Skip to step 3 to view real time data.
 - a. [Selecting Measurements to Log or Publish on page 82](#)
 - b. [Defining the Logging Intervals on page 50](#)
 - c. [Starting the Data Logging on page 96](#).

NOTE: The amount of data collected affects the ability to display certain dashboard options, for example a year over year dashboard.

3. View real time data for one or more devices: [Viewing Real Time Data for a Single Device on page 100](#) or [Viewing a Device Summary on page 101](#).

Quickstart: Setting Up Publication

The steps below are a summary of publishing options. Refer to complete chapters for a full description of publishing per platform.

1. Choose the platform and publication frequency as in [Selecting Platform and Publication Frequency on page 41](#). For each platform, see these related tasks:
 - The appendix [Publish Data to Energy Operation on page 156](#) describes configuring the Com'X 510 for use with Energy Operation.
 - For a connection to a Schneider Electric subscribed service via Digital Service Platform (for example, Facility Insights), you must contact DSP support at dsp-support@schneider-electric.com to obtain a connection key. See [Digital Service Platform Connection on page 47](#).
 - For .csv export options, you may want to refer to [File Format of CSV Export on page 46](#).
2. Define the transfer protocol as in [Define the Transfer Protocol on page 42](#)
3. Start the publication as in [Starting the Publication on page 97](#)

Settings

This chapter describes how to configure the general settings of the Com'X 510.

⚠ WARNING

INACCURATE DATA RESULTS

- Do not incorrectly configure the software, as this can lead to inaccurate reports and/or data results.

Failure to follow these instructions can result in death, serious injury, equipment damage, or permanent loss of data.

General Settings

General Settings includes the following:

- [Date and Time Settings on page 29](#)
- [Network Settings on page 30](#)
- [Proxy Settings on page 39](#)
- [Publication on page 41](#)
- [Wi-Fi Access Point Settings on page 48](#)

Date and Time Settings

The **Date/Time Settings** subtab allows you to set the date and time by time zone through SNTP or manually.

The time and date settings must be set before connecting the Com'X 510 to the Digital Service Platform. When the Com'X 510 is connected to the Digital Service Platform, the date and time are regularly updated from a time server. Any manual changes on the date and time are overwritten.

We recommend selecting DST time zone when using Energy Operation to have consistent time stamping with the Com'X 510.

To set the date and time:

1. Click **Settings > General Settings > Date/Time Settings**.
2. Select the appropriate **Timezone** in the drop-down list. If a DST time zone is selected, the clock will automatically adjust for Daylight Saving Time.

3. Choose one of the following:
 - a. Click the **Today** button to set the date and time automatically with the date and time of your computer.
 - b. Manually enter the date and time in the date and time fields.
 - c. Select Yes for **SNTP support**, then enter an SNTP server address.
(Default: pool.ntp.org)
4. Click **Save changes**.

Network Settings

The Com'X 510 offers several connection interfaces:

- Ethernet with two ports
- Wi-Fi
- GPRS or 3G for isolated sites or sites where the IT administrator does not allow access to the network infrastructure.

The available interfaces are determined by the accessories connected to the Com'X 510: GPRS or 3G modem or Wi-Fi USB key.

Network Configuration Options

The Com'X 510 features two Ethernet ports as well as a bay for a GPRS module or a USB port for 3G modem.

This table presents the network configuration options of the Com'X 510:

Options	Port			
	Ethernet Port 1	Ethernet Port 2	Wi-Fi	GPRS/3G
GPRS/3G only	Configuration and data collection ⁽¹⁾	Configuration ⁽¹⁾ and data collection	Configuration ⁽²⁾	Data publishing
GPRS/3G and switched network	Configuration and data collection		Configuration ⁽²⁾	Data publishing
Wi-Fi only	Configuration and data collection ⁽¹⁾	Configuration ⁽¹⁾ and data collection	Configuration, data collection, and publishing	–
Wi-Fi and switched network	Configuration and data collection		Configuration, data collection, and publishing	–
2 Switched Ports (1 IP address for both)	Configuration, data collection and publishing		Configuration ⁽²⁾	–
2 Separate Ports (1 IP address for each)	Configuration and data publishing	Configuration and data collection	Configuration ⁽²⁾	–

Options	Port			
	Ethernet Port 1	Ethernet Port 2	Wi-Fi	GPRS/3G
(1) Preferred usage for this port.				
(2) Available only in Wi-Fi Access Point mode.				

With a GPRS or 3G Modem

The GPRS or 3G modem is used to publish data.

If you want to use Ethernet for data collection, configure the Com'X 510 in **GPRS/3G and Switched network**. Otherwise the Com'X 510 must be configured as **GPRS/3G only**.

When the Com'X 510 is configured in **GPRS/3G only**, the Ethernet port 2 acts as a DHCP server. This mode allows you to connect a PC for configuration.

If a Wi-Fi module is installed, it can be used to establish a connection with a PC, a tablet, or a smartphone to configure the system.

With a Wi-Fi Key

A Wi-Fi key can be used to publish data. If you want to use Ethernet for data collection, configure the Com'X 510 in Wi-Fi and switched network. Otherwise the Com'X 510 must be configured as Wi-Fi only.

Wired Ethernet

If the Com'X 510 does not use a GPRS/3G modem or a Wi-Fi module for data publishing, the two Ethernet ports can be configured separately.

Selecting a Network Configuration

To select the network configuration of the Com'X 510:

1. Click **Settings > General Settings > Network Settings**.
2. Select the network configuration in the **Choose your network configuration** drop-down list.
3. If necessary, enter the parameters for each connection interface displayed. Refer to the corresponding sections: [Configuring the Ethernet Ports on page 33](#), [GPRS/3G Settings on page 34](#), and [Configuring a Wi-Fi Network on page 39](#).
4. Click **Save changes**.
5. Wait at least five min for the Com'X 510 to reboot (see [Reboot Cases on page 31](#)). The power LED turns green when the reboot is complete.

Reboot Cases

This table describes the cases when changing the configuration causes an automatic reboot.

Initial Network Configuration	New Network Configuration
2 separate ports	<ul style="list-style-type: none"> • 2 switched ports • GPRS/3G and 2 switched ports • Wi-Fi and 2 switched ports
GPRS/3G only	<ul style="list-style-type: none"> • 2 switched ports • GPRS/3G and 2 switched ports • Wi-Fi and 2 switched ports
Wi-Fi only	<ul style="list-style-type: none"> • 2 switched ports • GPRS/3G and 2 switched ports • Wi-Fi and 2 switched ports
2 switched ports	<ul style="list-style-type: none"> • 2 separate ports • GPRS/3G only • Wi-Fi only
GPRS/3G and 2 switched ports	<ul style="list-style-type: none"> • 2 separate ports • GPRS/3G only • Wi-Fi only
Wi-Fi and 2 switched ports	<ul style="list-style-type: none"> • 2 separate ports • GPRS/3G only • Wi-Fi only

Ethernet Port Settings

The Com'X 510 features two Ethernet ports.

The Ethernet ports can be configured in two modes:

- Switch mode: two Ethernet ports share the same configuration.
- Upstream/downstream mode: two Ethernet ports are configured separately.

Switch Mode Configuration

This graphic illustrates the Ethernet port configuration in switch mode:

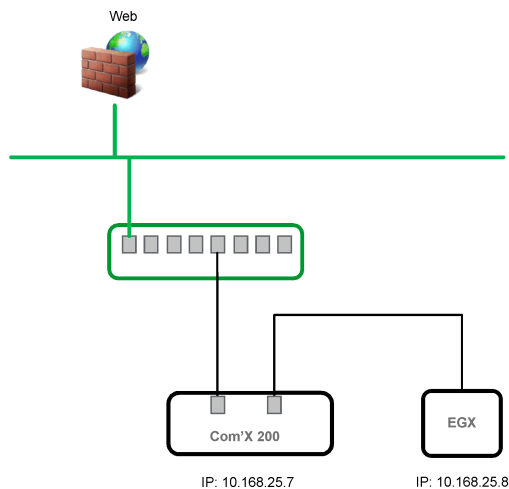

In switch mode, both Ethernet ports have the same settings. Using two ports simplifies wiring:

- one port can be connected to a switch in the local network.
- one port can be used to connect a PC for configuration operations or to connect a data collection device locally with an Ethernet port.

Upstream/Downstream Mode Configuration

This graphic illustrates the Ethernet port configuration in upstream/downstream mode:

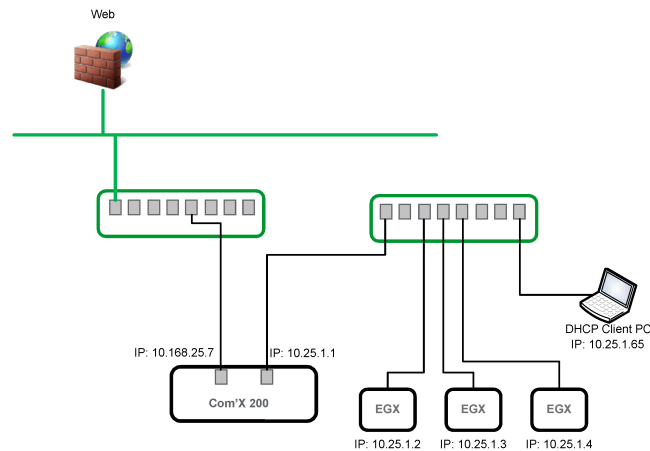

In upstream/downstream mode, the two Ethernet ports have different settings and function independently:

- one port must be used for data publishing.
- one port must be used for data collection.

The port used for data publishing (eth1) can be configured in DHCP client mode or static IPv4 address mode. The port used for data collection (eth2) can be configured in DHCP client, static IPv4 address, or DHCP server.

Ethernet Configuration Settings

DHCP client: The IP address is automatically assigned to the Com'X 510. When using Windows XP, it is recommended to have a fixed IP address (see [IPv4 Address Settings on page 176](#)), obtained by a DSL modem or by a network administrator.

Static IPv4 address: Type the IP, subnetwork mask, and default gateway addresses. Addresses are assigned to the Com'X 510 by the IT administrator.

Configuring the Ethernet Ports

This graphic shows the interface when the configuration of two separate ports is chosen:

The screenshot displays the 'Com'X 510' web interface. At the top, there's a status bar with the date '03/29/2016', time '10:10:11 PM', and system status 'Data logging ON' and 'Available storage: 3.4 GB'. Below this is a navigation menu with 'Settings' highlighted. The left sidebar contains a tree view with 'Network Settings' selected. The main content area is titled 'Ethernet configuration' and shows a dropdown menu set to '2 separate ports (1 IP address for each)'. Underneath, there are two sections: 'WAN configuration (eth1)' and 'LAN configuration (eth2)'. Each section has fields for 'Interface status', 'Configuration mode', 'IPv4 address', 'Subnet mask', and 'IPv6 link-local address'. The WAN status is 'ACTIVE' and LAN is 'UNDEFINED'. Below these is a 'General network settings' section with fields for 'Default gateway', 'Primary DNS server', and 'Secondary DNS server', each with a numeric input field. There is also a 'Reply to ping' checkbox which is currently set to 'No'. At the bottom right, there are 'Save changes' and 'Cancel' buttons.

To configure the two separate ports:

1. Click **Settings > General Settings > Network Settings**.
2. Select the **Choose your network configuration** field.

NOTE: If you change the configuration of the Ethernet port you are configuring through, you will be disconnected through the browser. Begin a new browsing session to continue configuration.

3. Select **2 Separate Ports (1 IP address for each)** in the drop-down list.
4. Select **DHCP client** and **Static IPv4 address** in the **Configuration mode** drop-down list.
5. In the **Ethernet configuration** collapsible menu, enter the parameters in the **WAN network configuration (eth1)** and **LAN network configuration (eth2)** fields. The **Interface Status** field changes to **ACTIVE** (if correctly wired).
6. In **General network settings** collapsible menu, type the addresses in the **Default gateway**, **Primary DNS server**, and, if necessary, **Secondary DNS server** fields. Addresses are assigned to the Com'X 510 by the IT administrator.
7. To enable ping replies, select **Yes** in **General network settings > Reply to ping**. Reply to ping is disabled by default.
8. Click **Save changes**.

GPRS/3G Settings

This table illustrates GPRS/3G settings:

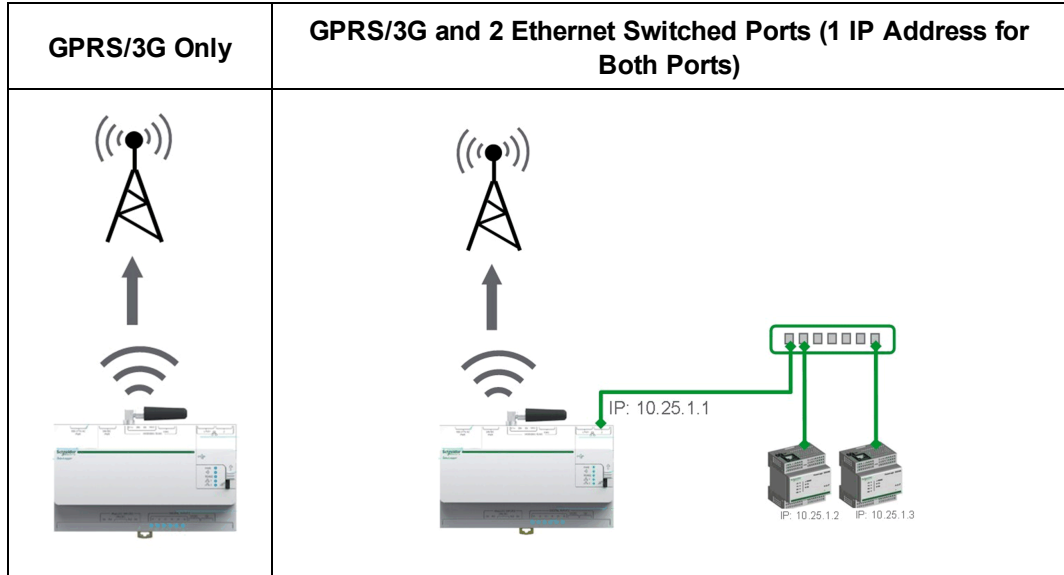

GPRS/3G access can be added to the Com'X 510 by installing a modem under the cover.

GPRS/3G network options depend on the modem that is connected. There are two reference numbers for the GPRS modem:

- **EBXA-GPRS-SIM** (see [Configuring Access Settings with EBXA-GPRS-SIM Card on page 37](#))
- **EBXA-GPRS** (see [Configuring Access Settings with EBXA-GPRS or a 3G Modem on page 37](#))

NOTE: GPRS/3G and wireless transmissions are sensitive to local environmental conditions, such as weather, network availability, and other GPRS/3G devices. You could incur increased communication costs in the event of low connectivity.

3G Modems

The following 3G modems have been tested and are compatible with the Com'X 510. For each modem, refer to the manufacturer's documentation for technical specifications and detailed installation instructions.

Manufacturer/Model	Antenna	Notes
MultiTech MTC-H5	External	<ul style="list-style-type: none"> • Recommended • Connect to the Com'X 510 internal USB port. • This modem must be mounted to the enclosure. Refer to the manufacturer's installation instructions.
Huawei MS2131i-8	Internal	<ul style="list-style-type: none"> • 55°C maximum operating temperature • Modem connects to internal USB port and mounts inside the Com'X 510 front door.
MultiTech MTD-H5	Internal	<ul style="list-style-type: none"> • Connect to the Com'X 510 internal USB port. • Modem must be extended outside the Com'X 510 front door (see instructions below).

Installing a 3G Modem on the Com'X 510

⚠ DANGER

HAZARD OF ELECTRIC SHOCK, EXPLOSION, OR ARC FLASH

- This equipment must only be installed and serviced by qualified personnel.
- Apply appropriate personal protective equipment (PPE) and follow safe electrical work practices. See NFPA 70E in the USA, CSA Z462 or applicable local standards.

Failure to follow these instructions will result in death or serious injury.

1. Power off the Com'X 510.
2. Open the Com'X 510 front door.

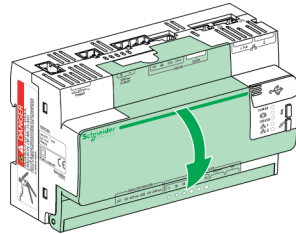

3. Connect the 3G modem.

- For modems that mount inside the Com'X 510, connect the modem to the internal USB port.

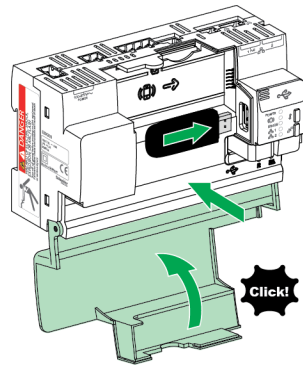

- For 3G modems that do not mount inside the Com'X 510 front cover, break off the tab to create an opening for the cable, then connect the modem cable to the internal USB port.

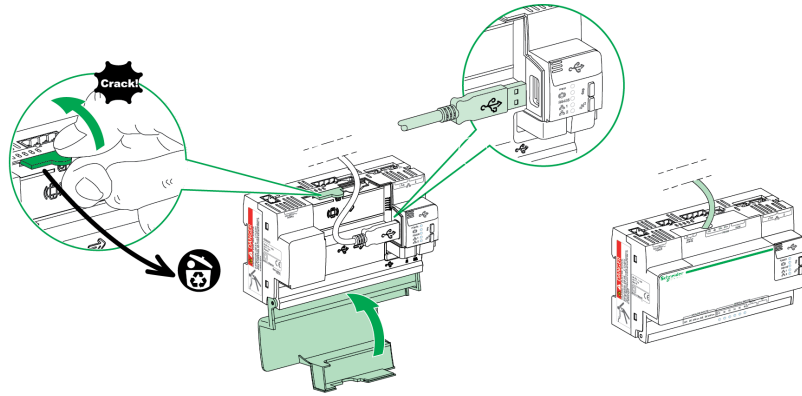

4. Close the Com'X 510 door as shown above.
5. Power on the Com'X 510. The Radio Modem LED flashes to show the modem has been detected.

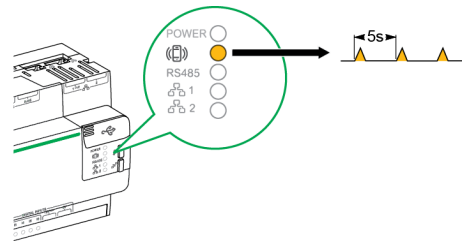

Configuring Access Settings with EBXA-GPRS-SIM Card

The SIM card is embedded in the GPRS modem. You can only use the EBXA GPRS SIM to publish data if you are exporting data to **Digital Service Platform**. The access settings of this GPRS modem are set by the Com'X 510.

The reference **EBXA-GPRS-SIM** must be selected for this GPRS modem.

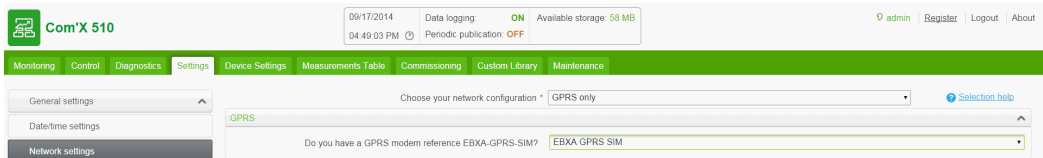

Configuring Access Settings with EBXA-GPRS or a 3G Modem

The EBXA-GPR/3G modem requires:

- a mini SIM 2FF type card.
- a minimum 1 MB/month data export on the telecom contract.

We recommend a robust M2M SIM card rather than a standard SIM card.

Follow this procedure for accessing GPRS/3G settings with an EBXA-GPRS or 3G modem:

1. Click **Settings > General Settings > Network Settings**.
2. Install the SIM card into the GPRS modem as described in the EBXA-GPRS/EBXA-GPRS-SIM Instruction Sheet, reference 253537613. For 3G, install the SIM card into the 3G modem as described in the manufacturer's installation instructions.
3. Type the **APN, Username, Password, and PIN Code** provided by the access provider.
4. Click **Save changes**.

NOTE: The PIN code and the password of the SIM card cannot be changed by the Com'X 510.

Wi-Fi Settings

This table illustrates Wi-Fi settings:

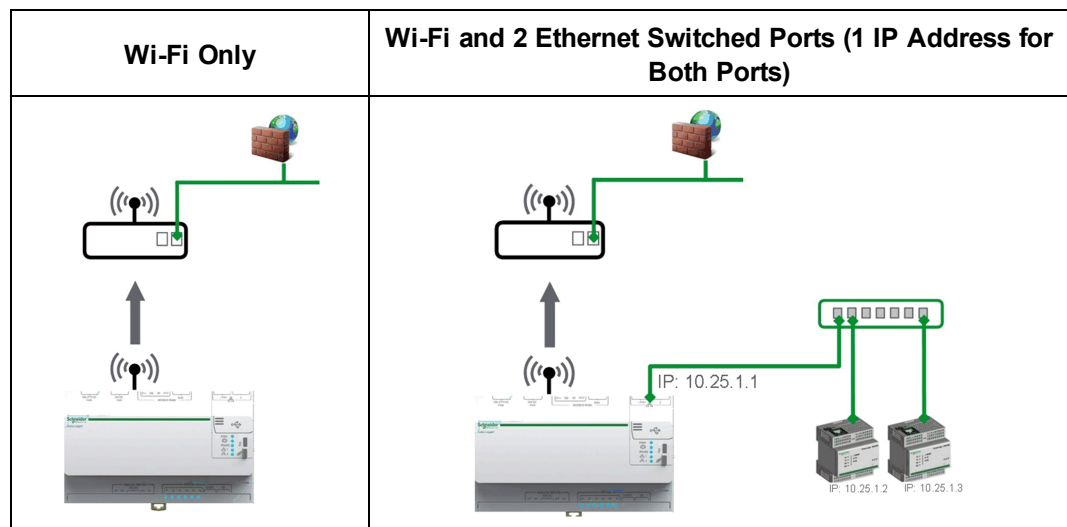

Use any USB port for temporary access, for example, to configure the Com'X 510. See [Wi-Fi Access Point Settings on page 48](#) for more information.

For permanent use, the Wi-Fi USB key must be installed outside the enclosure for EMC reasons. Schneider Electric provides accessories to mount the Wi-Fi key outside the enclosure.

NOTICE
<p>UNINTENDED EQUIPMENT OPERATION</p> <p>Do not install the Wi-Fi key inside a metallic enclosure.</p> <p>Failure to follow these instructions can result in equipment damage.</p>

The Com'X 510 does not enable Point-to-Point connections with other Wi-Fi field devices. Wi-Fi traffic is controlled by the Wi-Fi infrastructure of the site.

Configuring a Wi-Fi Network

1. Click **Settings > General Settings > Network Settings**.
2. Select **WiFi only** or **WiFi and 2 Switched Ports (1 IP address network)** in the **Choose your network configuration** dropdown list.

NOTE: Schneider Electric recommends using WPA2.

3. Click Select a Wi-Fi network in the Wi-Fi settings collapsible menu.
4. Click Refresh network list to scan all the Wi-Fi networks available.
5. Select the Wi-Fi network required. Type the key in the Secure key field if the key does not appear automatically.
6. Select Other if the required Wi-Fi network does not automatically appear in the list of Wi-Fi networks. Type the SSID and the key in the Secure key field.
7. Click **Save changes**.

Proxy Settings

It is necessary to configure Internet proxy settings in the Com'X 510:

- if you use the HTTP or HTTPS protocols, and
- if the network administrator has implemented an Internet proxy on your local network

Configuring Proxy Settings

This graphic shows the interface of proxy settings:

The screenshot displays the 'Proxy settings' configuration page in the Com'X 510 web interface. The page is titled 'Com'X 510' and shows the current date and time as 09/18/2014, 08:27:27 AM. The user is logged in as 'admin'. The navigation menu includes 'Monitoring', 'Control', 'Diagnostics', 'Settings', 'Device Settings', 'Measurements Table', 'Commissioning', 'Custom Library', and 'Maintenance'. The 'Settings' menu is expanded, showing 'General settings', 'Data/time settings', 'Network settings', 'Proxy settings' (selected), 'Publication', 'Wi-Fi access point settings', 'Site', 'Communication', 'User Management', and 'links'. The main content area is divided into three sections: 'HTTP Proxy settings', 'HTTPS Proxy settings', and 'HTTPS Redirection'. Each section has a 'Yes' and 'No' radio button for enabling the feature. The 'HTTP Proxy settings' section has 'Enable HTTP proxy support' checked, 'Proxy address' set to 'pipesrhn.eud.schneider-electric.com', and 'Proxy port' set to '8080'. The 'HTTPS Proxy settings' section has 'Enable HTTPS proxy support' and 'Use HTTPS settings' checked. The 'HTTPS Redirection' section has 'Enable HTTPS redirection' checked. At the bottom right, there are 'Save changes' and 'Cancel' buttons.

Follow this procedure to configure the Internet proxy settings in the Com'X 510:

1. Click **Settings > General Settings > Proxy Settings**.
2. Select the **HTTP Proxy settings** or **HTTPS Proxy settings** field.
3. Select the **Enable HTTP proxy support** check box.
4. Type the address and port of the proxy in the **Proxy address** and **Proxy port** fields.

5. If proxy authentication is required, select **Yes** for **Proxy requires authentication**, and enter the login and password to the proxy.
6. Click **Save changes**.

The proxy address and port number are provided by your network administrator, or you can retrieve these values in the **Internet Options** of a PC connected to the LAN.

Retrieving Proxy Values

This graphic shows the interface to retrieve proxy values from Internet Explorer:

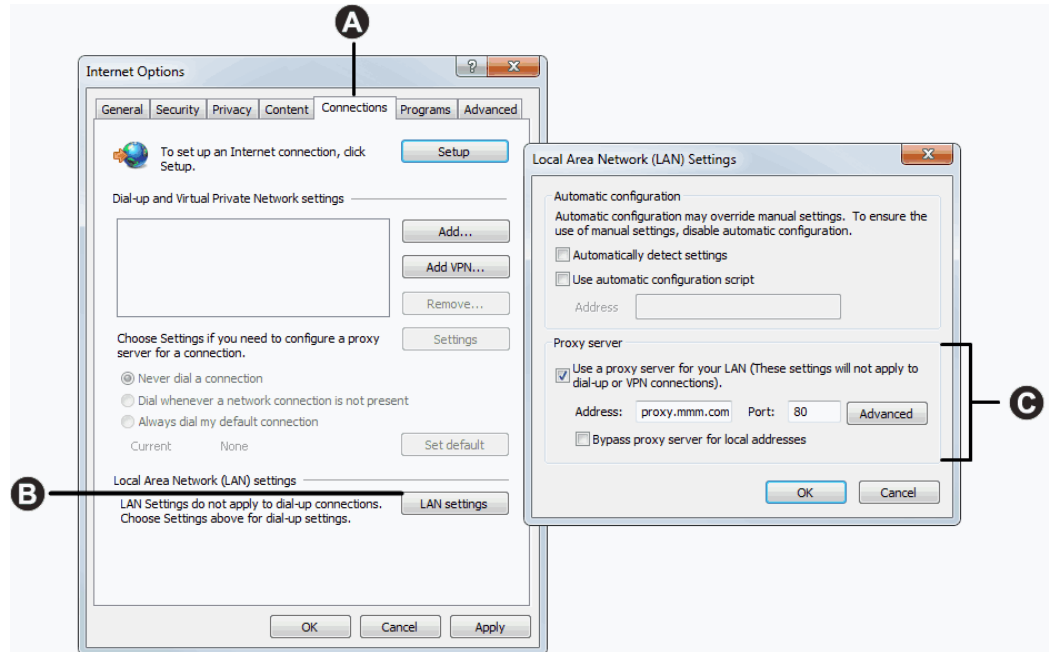

A	Connections tab
B	Local Area Network (LAN) settings
C	Proxy server with address and port

Follow this procedure to retrieve proxy values using Internet Explorer:

1. Click the **Tools** menu.
2. Select **Internet Options** in the drop-down list.
3. Select the **Connections** tab.
4. Click the **LAN settings** button.
5. Read the values of the proxy in the **Local Area Network (LAN) Settings** window.
6. Copy the same values into the Com'X 510 proxy settings.

Publication

Use the **Publication** subtab to select the platform to which the logged data is sent.

The Com'X 510 can publish data to three different Schneider Electric platforms (database servers):

- Energy Operation
- Digital Service Platform (DSP)
- CSV Export

The Com'X 510 exports the data in the correct file format according to the selected platform. Then the data can be analyzed in the service to which you have subscribed.

The subscription to Energy Operation or DSP must be set up with a Schneider Electric representative before setting up the Com'X 510 **Destination platform**.

NOTE: To publish to DSP, you must enable Schneider Electric Services in **Settings > General Settings > Schneider Electric Services**.

With **CSV Export**, the Com'X 510 exports data to your own database server in a .csv file.

Selecting Platform and Publication Frequency

This graphic shows the interface to select the destination platform and publication frequency:

The screenshot displays the Com'X 510 web interface. At the top, there is a header with the device name 'Com'X 510', a date and time '11/19/2015 02:38:48 PM', and status indicators for 'Data logging: ON', 'Periodic publication: ON', and 'Available storage: 3.5 GB'. Below the header is a navigation menu with tabs: 'Monitoring', 'Control', 'Diagnostics', 'Settings', 'Device Settings', 'Measurements Table', 'Commissioning', 'Custom Library', and 'Maintenance'. The 'Settings' tab is active, and a sidebar on the left shows a list of settings categories: 'General Settings', 'Schneider Electric Services', 'Date/Time Settings', 'Network Settings', 'Proxy Settings', 'Publication' (highlighted), 'Wi-Fi Access Point Settings', 'Site Settings', 'Communication', 'Security', 'User Management', and 'Links'. The main content area is titled 'Publication settings' and contains the following configuration options:

- Destination platform *
- Publication frequency *
- Protocol *
- Server *
- Port *
- Authentication required * Yes No
- User login *
- User password *
- Directory *
- Passive mode * Yes No
- Compression activated * Yes No
- Field separator *
- Decimal separator *
- Date Format *

At the bottom right of the form, there is a legend for a required field (marked with an asterisk), and three buttons: 'Save changes' and 'Cancel'.

Follow this procedure to select the destination platform and publication frequency:

1. Click **Settings > General Settings > Publication**.
2. Select the **Destination platform** in the drop-down list.
3. Select how often the data is sent in the **Publication frequency** drop-down list:

- Weekly: select the day of the week.
- Daily: the data is sent at 1:00 a.m. local time.
- For higher frequencies, publication times are calculated starting at 0:00 a.m. For example, if **Every 2 hours** is selected, data is sent at 0:00 a.m., 2:00 a.m., 4:00 a.m., and so on. If **Every 3 hours** is selected, data is sent at 0:00 a.m., 3:00 a.m., 6:00 a.m., and so on.

4. Click **Save changes**.

NOTE: The first publication occurs on the first hour that matches the selected frequency after the **Start publication** task in [Commissioning on page 95](#). For example, if **Every 2 hours** is selected and the publication starts at 9:45 a.m., the first publication is at 10:00 a.m.

Define the Transfer Protocol

There are different ways to export the data. The protocols in the **Protocol** drop-down list vary depending on the selected platform, as shown in this table:

Platforms	Supported Transfer Protocols	File Format
Energy Operation	<ul style="list-style-type: none"> • FTP • HTTP and HTTPS 	XML
Digital Service Platform	Automatically defined by the Com'X 510	EWS
CSV export	<ul style="list-style-type: none"> • FTP • HTTP and HTTPS • SMTP 	CSV

NOTICE

HAZARD OF UNAUTHORIZED ACCESS

Use the HTTPS transfer protocol.

Failure to follow these instructions can result in equipment damage.

To define the transfer protocol for publication, see one of the following:

- [Configuring FTP Transfer Protocol on page 42](#)
- [Configuring HTTP and HTTPS Transfer Protocols on page 43](#)
- [Configuring SMTP Transfer Protocol on page 45](#)

Configuring FTP Transfer Protocol

This graphic shows the interface when selecting FTP protocol:

The screenshot shows the 'Publication settings' page in the Com'X 510 web interface. The left sidebar contains a menu with 'Publication' highlighted. The main content area displays various configuration fields:

- Destination platform: CSV export
- Publication frequency: Every hour
- Protocol: FTP
- Server: 10.167.231.46
- Port: 21
- Authentication required: Yes
- User login: admin
- User password: masked with asterisks
- Directory: /Public/temp/ComX_PublishedData/2015/ComX_510_DEMO
- Passive mode: Yes
- Compression activated: Yes
- Field separator: Comma
- Decimal separator: Dot
- Date Format: MM-DD-YYYY

At the bottom right, there are buttons for 'Save changes' and 'Cancel', along with a 'Required field' indicator.

To transfer data with the FTP protocol:

1. Click **Settings > General Settings > Publication**.
2. Select the **Destination platform** in the drop-down list.
3. Select FTP in the **Protocol** drop-down list.
4. Type the address of the server transporting the data in the **Server** field.

NOTE: Server address for Energy Operation is automatically filled. Do not modify the server address.

5. Type the outgoing delivery port in the **Port** field. The factory setting is 21.
6. Select **Yes** in the **Authentication required** field for any platform requiring authentication, for example Energy Operation.
7. Type the username and the password. For Schneider Electric platforms, this information is given with the subscription contract. Contact the Schneider Electric representative to provide you with this information.
8. For CSV, type the directory information for the remote server in the **Directory** field.
9. Click **Save changes**.

NOTE: FTP is unsecured, as login ID and password are communicated in clear text. Schneider Electric recommends using HTTPS instead.

Configuring HTTP and HTTPS Transfer Protocols

This graphic shows the interface when selecting HTTP or HTTPS protocols:

The screenshot shows the 'Publication settings' page in the Com'X 510 web interface. The left sidebar contains a menu with 'Publication' highlighted. The main content area has the following fields and values:

- Destination platform: Energy Operation
- Publication frequency: Daily
- Protocol: HTTP
- Server: http.push.energyoperation.schneider-electric.com
- Port: 80
- Authentication required: Yes
- User login: PS2-Sandbox1_EO
- User password: [masked]
- Path: /
- Field name: datafile1
- Publication ID: 13053916337976

Buttons at the bottom include 'Generate New Publication ID', 'Save changes', and 'Cancel'. A note at the bottom states: 'You can register to Schneider-Electric web portal for easy registration and management of your software licence.'

Follow this procedure to transfer data with the HTTP or HTTPS protocols:

1. Click **Settings > General Settings > Publication**.
 2. Select the **Destination platform** in the drop-down list.
 3. Select HTTP or HTTPS in the **Protocol** drop-down list.
 4. Type the address of the server transporting the data in the **Server** field. The server address is automatically filled for Energy Operation. Do not modify the server address for this platform.
 5. Type the outgoing delivery port in the **Port** field. The factory setting is 80 for HTTP and 443 for HTTPS.
 6. Select **Yes** in the **Authentication required** field for any platform requiring authentication, for example Energy Operation.
 7. Type the username and the password. For Schneider Electric platforms, this information is given with the subscription contract. Contact the Schneider Electric representative to provide you with this information.
- NOTE:** The username and password are case-sensitive.
8. In the **Path** field, type the path to the server script executed by the web server when the Com'X 510 sends data to the web server. This field is already filled with a /. Do not modify this value when Energy Operation is selected as a platform.
 9. According to your network administrator either:
 - type the file name that the web server expects in the **Field Name** field (only for CSV), or
 - use the **datafile1** factory setting.
 10. Click **Save changes**.

NOTE: HTTP is unsecured, as login ID and password are communicated in clear text. Schneider Electric recommends using HTTPS instead.

Certificate considerations for HTTPS

You can secure the HTTP connection to your server with TLS/SSL technology.

As with a web browser, the box is preloaded with all the major certificate authorities as of the time of the firmware release. See [List of Certificate Authorities on page 170](#). Schneider Electric offers an update of the list of certificate authorities with the firmware updates.

This means that your HTTPS server certificates must have been issued by one of the box's trusted certificate authorities. Check with your IT department to know if your HTTPS server certificate complies with this rule. If not, you can select HTTP.

Configuring SMTP Transfer Protocol

The SMTP protocol is available only with a CSV export.

This graphic shows the interface when selecting SMTP protocol:

The screenshot displays the 'Publication settings' configuration page in the Com'X 510 web interface. The page includes a navigation menu on the left with options like 'General settings', 'Data/time settings', 'Network settings', 'Proxy settings', 'Publication', 'Wi-Fi access point settings', 'Site', 'Communication', 'User Management', and 'Links'. The main content area shows the following settings:

- Destination platform:** CSV export (with a warning message: "This service doesn't include automatic firmware update. Please check that your Com'X 200 runs with the last firmware version. We advice you to update your Com'X 200 if this is not the case")
- Publication frequency:** Daily
- Protocol:** SMTP
- Server:** (empty field)
- Port:** 25
- Authentication required:** Yes (selected)
- User login:** (empty field)
- User password:** (empty field)
- From address:** comx510_Lavergne@schneider-electric.com
- To addresses:** (empty field)
- Field separator:** Comma
- Decimal separator:** Dot
- Date Format:** YYYY-MM-DD

At the bottom, there is a link for 'Register to Support - Software Licensing' and a note: 'You can register to Schneider-Electric web portal for easy registration and management of your software licence.' The page also features a status bar at the top with the date '09/30/2014', time '03:22:30 PM', and system status indicators for 'Data logging: ON', 'Available storage: 3.7 GB', and 'Periodic publication: OFF'.

To send the data file by email with the SMTP protocol:

1. Click **Settings > General Settings > Publication**.
2. Select CSV export in the **Destination platform** drop-down list.
3. Select SMTP in the **Protocol** drop-down list.
4. Type the address of the server transporting the data in the **Server** field.
5. Type the outgoing delivery port in the **Port** field. The factory setting is 25.
6. Select **Yes** in the **Authentication required** field if the SMTP server requires authentication.
7. Type the username and the password. This information is given with the subscription contract. Contact your local IT representative to get this information.

NOTE: The username and password are case-sensitive.

8. Type the address of the email sender in the **From address** field. The factory setting is in

the format: `ComX200_SiteName@schneider-electric.com`.

NOTE: Most SMTP servers require a **From address**.

9. Type the addresses of the recipients in the **To addresses** field. Separate the addresses with a semicolon (;). Exported files are zipped to reduce the size of attached documents in the email.
10. Click **Save changes**.

NOTE: SMTP is unsecured, as login ID and password are communicated in clear text. Schneider Electric recommends using HTTPS instead.

Publication Identification Settings

This table describes the publication identification settings for Energy Operation:

Field/Button	Description
Publication ID	<p>This number is a unique identifier of the site for the Energy Operation database. It is used to create a site in Energy Operation.</p> <p>This ID is automatically generated by the Com'X 510.</p>
Generate new publication ID	<p>This button generates a new publication ID number. Use this button whenever you reuse:</p> <ul style="list-style-type: none"> • the Com'X 510 for a new site. • the current Com'X 510 configuration on a different site.

File Format of CSV Export

There is one file exported for each device.

Exported files are in the following naming format: `Device Name_Date&time.csv` where `Device Name` is the name given to the slave device. The date and time are appended to the file name in the following format: `_yyyymmddhhmmss`.

For example:

- Device name: `Building 1 Utility Entrance`
- Date/time: `20130218115216`

The exported file is named `Building 1 Utility Entrance_20130218115216.csv` and was exported on February 18, 2013 at 11:52:16 a.m.

The following table provides the details of each line of a CSV file, with sample data:

Row	Data in CSV Format	Description
1	[Gateway Name, Gateway SN, Gateway IP Address, Gateway MAC Address, Device Name, Device Local ID, Device Type ID, Device Type Name, Logging Interval, Historical Intervals]	This row contains the column headings for the information in row 2.
2	[ComX510_F930B8, DN13045SBX10091, 10.195.23.45, 00:80:67:F9:30:B8, COMX_008067F930B8_1, Resource-1, PM810, PM810, 30, 6, 23227, 157.198.184.116, Building 1 Utility Entrance, 3, CM4000, 15]	This row contains the information about the Com'X 510 and the logged device.
3	This row is left blank.	–
4	[...Topic ID 1, Topic ID 2, Topic ID 3]	This row contains the column headings for the topic IDs ⁽¹⁾ in row 5. The first 3 commas are used for layout purposes in a spreadsheet application.
5	[...1617, 1621, 1625]	This row contains the topic IDs of the values logged.
6	This row is left blank.	–
7	[Error, UTC Offset (Minutes), Local Time Stamp, Apparent Energy (kVAh), Real Energy (kWh), Reactive Energy (kVARh)]	This row contains the column headings for the data logged in rows 8 and higher.
8 and higher	[0, -300, 2008-10-09 14:15:00, 1400738, 219, 1201962.707, 647069.906, 15] [0, -300, 2008-10-09 14:20:00, 1400758, 260, 1201980.725, 647078.602, 15] [0, -300, 2008-10-09 14:25:00, 1400778, 198, 1201998.661, 647087.233, 15]	These rows contain the logged data.

⁽¹⁾ A topic ID is a numerical reference to the quantity being logged. The name given to a quantity may slightly differ between devices and languages. Topic IDs are used to identify the quantity regardless of the device or language.

Digital Service Platform Connection

To publish to DSP, you must enable Schneider Electric Services in **Settings > General Settings > Schneider Electric Services** and enter a **Connection key**. To obtain this key, contact DSP support at dsp-support@schneider-electric.com.

This table describes the status when connecting to the Digital Service Platform:

Field	Description
Authenticate	<p>Connection process is starting.</p> <p>If a network error occurs, check:</p> <ul style="list-style-type: none"> the IP settings in the Settings > General Settings > Network Settings page. the proxy settings in the Settings > General Settings > Proxy Settings page. the date and time settings in Settings > General Settings > Date and Time Settings. Verify that the key entered matches the one provided by DSP support.
Connect	<p>Connection is established with the remote service.</p> <p>Your device has been identified on the remote platform.</p> <p>The Com'X 510 tries to publish a test message.</p> <p>If a connection error occurs, check the date and time settings in Settings > General Settings > Date and Time Settings.</p>
Active	<p>Publication is possible only when this status is displayed.</p> <p>If this message does not display, contact DSP support.</p>

When using the DSP connection, firmware upgrades are automatically launched. If you want to use the DSP platform through a GPRS connection, we recommend that you update the firmware before setting up DSP. Refer to [Upgrading Firmware via DSP on page 144](#) for more information.

Wi-Fi Access Point Settings

The USB Wi-Fi key can be used as a temporary communication medium during the commissioning phase. It allows you to use a laptop or a tablet to configure the Com'X 510.

In this case, communication is direct between the Com'X 510 and the laptop or tablet. The Com'X 510 functions as a Wi-Fi access point.

Wi-Fi access can be added to the Com'X 510 using a Wi-Fi USB key inserted under the cover or on the front face. Schneider Electric recommends using the front face USB, as you can easily remove the USB key after configuration is done.

Installing the Wi-Fi USB key directly on a Com'X 510 port is allowed only for temporary access point connection for configuration.

Activating the Wi-Fi Access Point

This graphic shows the interface for Wi-Fi access point settings:

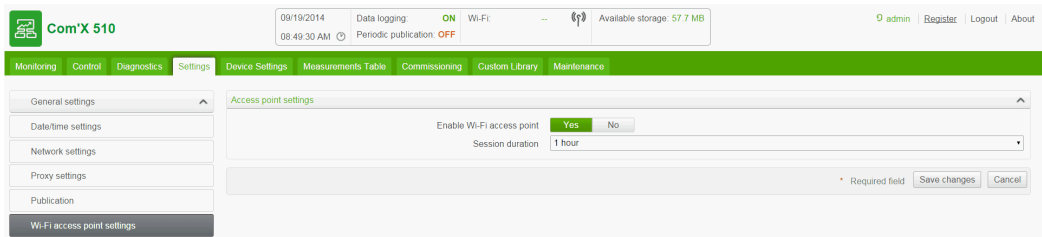

Follow this procedure to activate the Wi-Fi access point mode:

1. Click **Settings > General Settings > Wi-Fi Access Point Settings**.
2. Click **Yes** to **Enable Wi-Fi access point**.
3. Select the duration in the **Session duration** drop-down list (Default: 1 hour).
4. Click **Save changes**.

If **Session duration** is modified during a Wi-Fi access point session, the modification is taken into account at the next session.

NOTE: This setting only enables access point mode. To start the Wi-Fi access point mode session, push the Wi-Fi button  located near the USB port on the front face (see [Accessing Through Wi-Fi Access Point Mode on page 19](#)). The Wi-Fi button LED flashes green.

Deactivating the Wi-Fi

To end the Wi-Fi access point session, press the Wi-Fi button on the front of the Com'X 510. The Wi-Fi button LED flashes orange.

Site Settings

Site Information

The **Site name** field that appears in the **Site Information** collapsible menu is used as a site name by different platforms. All measurements are assigned to this site location.

In **Energy Operation**, the **Site name** parameter is used to create the site location name that appears in Energy Operation platform environment.

Configuring Site Information

To change the site name:

1. Click **Settings > General Settings > Site Information**.
2. Enter the site location name.

NOTE: The site name must not include any of these characters: `/:*?<>|` or space.

3. Click **Save changes**.

Data Logging

The Com'X 510 can log data at pre-defined intervals. The logging interval can be set for each type of commodity, for example, electricity, water, or gas. Each device can report only one type of commodity.

Defining the Logging Intervals

It is important to consider how much data is being logged across all devices when selecting the logging interval and number of topics to log. Logging too many topics per interval may affect Com'X 510 performance, including degraded web page response and missed logging intervals.

For example, for a logging interval of less than five minutes, we recommend that you log no more than 8 devices with 50 total topics.

To define the logging intervals:

1. Click **Settings > Site Settings > Data Logging**.
2. Select your country.

NOTE: This will automatically set the logging intervals of data for different commodities in the country. You can also edit these intervals individually.

3. Click **Save changes**.

Communication Settings

This section describes how to configure the communication settings of the Com'X 510.

Modbus TCP Access

The Com'X 510 is both a Modbus TCP gateway and, using the internal Modbus TCP server, a Modbus device.

Modbus TCP Gateway

The Com'X 510 acts as a Modbus gateway for wired or wireless Ethernet communications from an upstream PC to Ethernet devices and field instruments on the downstream network. This capability allows the user of local or cloud-based monitoring software to access information from devices for data collection, historical trending, analysis, and other functions.

Accessing the Internal Modbus Slave Device

The internal Modbus TCP server allows reading the digital input and analog input values of the Com'X 510 via various Modbus registers (see [Modbus Register Mapping on page 179](#)). These registers can be read using Modbus slave ID 255.

After you configure the Com'X 510 inputs in **Device Settings**, values are accessible through the gateway. The register values can also be viewed in the **Measurements Table** tab for measurements selected for logging (see [Selecting Measurements to Log or Publish on page 82](#)).

The internal Modbus TCP server is active when Modbus TCP/IP communications is enabled via [Firewall Management on page 59](#).

Companion Software Modbus TCP/IP Server Function

Downstream Modbus devices can be accessed from an upstream PC running a software application. Recommended software applications offered by Schneider Electric include:

- Remote Setting Utility software for Masterpact and Compact NSX
- StruxureWare Power Monitoring Expert software.

Modbus Gateway Settings

Modbus Gateway Settings allows you to customize network settings for your specific environment. The defined parameters apply to both Ethernet ports.

Setting	Description	Options
Serial Port		
Transmission Mode	Used to select how data is transmitted over a serial connection.	RTU, ASCII Default: RTU
Silent Interval Extension (ms)	Allows the silent interval used to signify the end of a Modbus RTU packet to be extended beyond the 3.5 characters defined by the standard.	0–10 ms Default: 5 ms
Delay Between Frames (ms)	Defines the minimum silent time between the end of a received response and the beginning of a new request on the serial line.	0, 10, 20, 30, 40, 50, 60, 70, 80, 90, 100 Default: 50 ms
TCP/IP Server		
Enable Server Connection Idle Time	Enables a timer that closes the Modbus TCP/IP connection after a specified amount of idle time.	Yes, No Default: No
Server Connection Idle Time	Length of time after which a TCP/IP connection is closed.	1–65535 seconds
Enable Modbus TCP/IP Proxy	Setting that determines if Modbus TCP/IP messages from remote clients will be routed to remote Modbus TCP/IP devices that are defined in the Com'X 510.	Yes, No Default: Yes

Setting	Description	Options
Enable Serial Modbus Broadcasts	Forwards received Modbus broadcast messages to the slave devices connected to the local serial port.	Yes, No Default: No
TCP/IP Client		
Client Connection Timeout (seconds)	Amount of time the Com'X 510 will wait for a remote Modbus TCP/IP device to respond to a Modbus TCP/IP connection request initiated by the Com'X 510.	.1–10 seconds Default: 2
Client Message Timeout (seconds)	Amount of time the Com'X 510 will wait for a remote Modbus TCP/IP device to respond to a Modbus TCP/IP request initiated by the Com'X 510.	1–20 seconds Default: 3

Configuring the Com'X 510 Modbus Gateway

NOTICE

IMPAIRED NETWORK PERFORMANCE

Only qualified workers should modify the Modbus gateway settings. Such modifications should be performed only after reading about and understanding the Modbus gateway settings.

Failure to follow these instructions can impair network performance.

To configure the Com'X 510 Modbus gateway settings:

1. Click **Settings > Communication > Modbus Gateway**.
2. Select the required **Transmission Mode**, **Silent Interval Extension**, and **Delay Between Frames** for the serial port.
3. Select **Yes** or **No** to **Enable Server Connection Idle Time**, **Enable Modbus TCP/IP Proxy**, and **Enable Serial Modbus Broadcast** for the TCP/IP server. Enter a **Server Connection Idle Time** in seconds, if enabled.
4. Select the required TCP/IP client values for **Client Connection Timeout** and **Client Message Timeout**.
5. Click **Save changes**.

Local ID Settings and Device IDs

In order for an external Modbus TCP/IP client to access a device connected to the Com'X 510, each device must have a unique ID, or **Local ID**. The **Local ID** is automatically assigned whenever a device is created and is associated with a device's **Slave ID**.

The **Slave ID** is either

- the configured Modbus ID of any device connected to the RS485 serial port,
- the configured Modbus ID of a connected Modbus TCP/IP device, or
- the ID used by a Modbus TCP/IP gateway that connects a device to an Ethernet network.

You can change the **Local ID** in **Settings > Communication > Modbus Gateway > Device IDs**. The **Local ID** must be unique and can only be changed if data logging is disabled for the device being updated. See [Starting the Data Logging on page 96](#)

The **Devices** page also provides the following information for each device:

- **Slave ID**
- **Connection:** "Serial Port," IP address for remote devices, or Zigbee ID
- **Device Type** as defined in **Device Settings**

Modbus TCP/IP Filtering

This function allows the administrator to create a whitelist and assign the level of access IP addresses have to the Com'X 510 and its downstream devices.

When enabled, the default access level is **Read** for any Modbus TCP/IP client not in the filtered list. Setting the **Default Access** field to **None** blocks all Modbus TCP/IP clients not in the filtered list.

To create a filter:

1. Click **Settings > Communication > Modbus TCP/IP Filtering**.
2. Click **Yes** to enable filtering.
3. In the Whitelist column, enter the IP address you want to filter on.

NOTE: An empty octet field is treated as a wildcard. Empty fields must begin with the least significant octet and be contiguous. The most restrictive filter is applied in cases of contradiction.

4. Select the access level: **None**, **Read**, or **Full**.
5. Optionally, you can edit the **Default Access: Read** or **None**.
6. Click **Save changes**.

Modbus Serial Port

The RS-485 serial line standard is an industrial standard. If configured correctly, it can potentially reduce transmission errors even in an environment with electrical disturbances.

This section describes the serial line properties of the local Modbus/RS-485 network controlled by the Com'X 510.

Modbus Serial Port Settings

The Com'X 510 is the master of the Modbus serial line. All the other devices connected to this serial line must be configured as Modbus slaves. The slave device settings such as **Baud rate**, **Parity**, and **Number of stop bits** must match the Com'X 510. These settings are set by using the front display of each device.

This table describes the Modbus serial port settings:

Field	Description	Options
Baud rate	Defines the speed of the serial line.	1200, 4800, 9600, 19200, 38400, 57600, and 115200 Bauds. ⁽¹⁾ The factory setting is 19200 to match the values of Schneider Electric equipment. Most third-party Modbus equipment supports this Baud rate.
Parity	Defines the parity bit of the transmitted bytes.	<ul style="list-style-type: none"> • odd⁽²⁾ • even • none The factory setting is even to match the values of Schneider Electric equipment. Most third-party Modbus equipment supports this parity setting.
Number of stop bits	Defines the number of stop bits transmitted between 2 bytes.	1 or 2 The factory setting is 1 to match the values of Schneider Electric equipment. Most third-party Modbus equipment supports this number of stop bits.
Timeout	Defines the time the Com'X 510 has to wait before generating an error for an unanswered Modbus request.	100 to 10000 ms The factory setting is 1000 ms to match the values of Schneider Electric equipment.
Terminator resistance	Has a value of 120 Ω.	Yes or No NOTE: Terminator resistance must be activated if the Com'X 510 is located at the end of the Modbus bus. Not following this rule can result in communication interruption.

Field	Description	Options
Serial line polarization	Has a value of 510 Ω .	Yes or No NOTE: We recommend that the master polarizes the line. No other slave device has to support line polarization resistances or to activate serial line polarization resistances.
<p>(1) A high Baud rate value reduces response time but may be more sensitive to disturbance. In case of disturbance, check the impedance on the serial line before reducing the Baud rate.</p> <p>(2) Even or odd settings enable a byte integrity check that may detect a transmission error at byte level. At this level, there is no advantage to use this check: Modbus protocol provides a CRC check that keeps the integrity of the whole Modbus frame.</p>		

Configuring Com'X 510 Modbus Serial Port Settings

NOTICE

IMPAIRED NETWORK PERFORMANCE

Only qualified workers should modify the Modbus serial port settings. Such modifications should be performed only after reading about and understanding the Modbus serial port settings.

Failure to follow these instructions can impair network performance.

Follow this procedure to set up the Com'X 510 Modbus serial line:

1. Click **Settings > Communication > Modbus Serial**.
2. Select the required value in the **Baud rate** drop-down list.
3. Select the required value in the **Parity** drop-down list.
4. Select the required value in the **Number of stop bits** drop-down list.
5. Select the required value in the **Timeout** drop-down list.
6. Select **Yes** in the **Terminator resistance** field if the bus is terminated at its end.
7. Select **Yes** in the **Serial line polarization** field if no other device in the line is providing polarization.
8. Click **Save changes**.

Advanced Ethernet Settings

Advanced Ethernet Settings allow you to customize network settings for your specific environment. The defined parameters apply to both Ethernet ports.

Setting	Description	Options
Time to Live	Identifies the number of routers a TCP packet can pass before it is discarded.	1-255 hops Default: 60 hops
Enable TCP Keep Alive	A keepalive is a message sent to check that the link between the Com'X 510 and its connected host is operating, or to prevent this link from being broken.	Yes or No Default: Yes
Time	Elapsed time between two successive keepalive retransmissions, if acknowledgment to the previous transmission is not received.	1-7200 seconds Default: 30 seconds

Configuring Advanced Ethernet Settings

NOTICE

IMPAIRED NETWORK PERFORMANCE

Only qualified workers should modify the advanced Ethernet settings. Such modifications should be performed only after reading about and understanding the advanced Ethernet settings.

Failure to follow these instructions can impair network performance.

1. Click **Communications Settings > Advanced Ethernet Settings**.
2. Enter the **Time to Live**.
3. **TCP Keep Alive** is enabled by default. Either
 - enter the keep alive time, or
 - click No to disable **TCP Keep Alive**.
4. Click **Save changes**.

To return to the values in [Advanced Ethernet Settings on page 55](#), click **Default**.

ZigBee Network Settings

ZigBee is a wireless networking standard for remote control and sensor applications. You can add up to 20 ZigBee devices to the Com'X 510 (Zigbee dongle **EBXA-USB-Zigbee** defines the number of ZigBee devices allowed).

Creating a ZigBee Network for the First Time

Schneider Electric provides accessories to mount the ZigBee key outside the cabinet. For information, see the ZigBee Instruction Sheet.

Use this procedure when a ZigBee network has never previously been created for the Com'X 510.

NOTICE

UNINTENDED EQUIPMENT OPERATION

Do not mount the ZigBee key inside the cabinet or switchboard when using the High power transmission setting.

Failure to follow these instructions can result in equipment damage.

1. Power off the Com'X 510.
2. Plug the ZigBee key into one of the USB ports in the Com'X 510, or connect it to the Com'X 510 through a USB extension cable.
3. Power on the Com'X 510 and wait for its power LED to turn green.

NOTE: The ZigBee key firmware is deployed with the Com'X 510 firmware. The Com'X 510 automatically updates the firmware if a newer version is available.

4. Log in to the Com'X 510, and then select **Settings > Communication > ZigBee Settings**. The ZigBee Settings screen is displayed.
5. In the **Activate ZigBee** field, select **Yes**.
6. (Optional) In the **Channel** field, select a ZigBee channel. If you leave the setting as --, the Com'X 510 scans all available channels and automatically selects a channel for the ZigBee network. The channel with strongest signal is usually selected.
7. In the **Transmission power** field, select one of the following options:
 - **Standard power:** Select this option when the ZigBee key and all ZigBee devices are in the same switchboard or cabinet.
 - **High power:** Select this option when the ZigBee key is connected to the Com'X 510 through a USB extension cable. You are asked to confirm that the ZigBee key is outside the switchboard or cabinet. Click **OK** to confirm.
8. Click **Save changes**.

The setup takes about 60 seconds. When the network starts, the **ZigBee status** shows that the network is ready to be used, and the ZigBee key LED flashes green.

You can now use the ZigBee discovery function ([ZigBee Device Discovery on page 91](#)) to connect devices to the network.

Stopping and Restarting a ZigBee Network

Use this procedure to stop and restart a ZigBee network so that you can change the network settings or perform maintenance.

1. Log in to the Com'X 510, and then select **Settings > Communication > ZigBee Settings**. The **ZigBee Settings** screen is displayed.

2. In the **Activate ZigBee** field select **No**, and then click **Save changes**. The ZigBee status shows that no network is defined. You can now perform maintenance or change the network settings.
3. In the **Activate ZigBee** field, select **Yes**.
4. In the **Create New ZigBee Network** field, leave the value as **No**.
5. In the **Transmission power** field, select one of the following options:
 - **Standard power**: Select this option when the ZigBee key and all ZigBee devices are in the same switchboard or cabinet.
 - **High power**: Select this option when the ZigBee key is connected to the Com'X 510 through a USB extension cable. You are asked to confirm that the ZigBee key is outside the switchboard or cabinet. Click **OK** to confirm.
6. Click **Save changes**. The setup takes a few seconds. When the network starts, the ZigBee status shows that the network is ready to be used, and the ZigBee key LED flashes green.

Recreating a ZigBee Network

Use this procedure to change the channels on a ZigBee network that has already been created for the Com'X 510.

NOTE: When you perform this procedure, all equipment that is connected to the ZigBee network is disconnected. You must use the ZigBee discovery function ([ZigBee Device Discovery on page 91](#)) to reconnect devices to the network.

1. Log in to the Com'X 510, and then select **Settings > Communication > ZigBee Settings**. The **ZigBee Settings** screen is displayed.
2. In the **Activate ZigBee** field select **No**, and then click **Save changes**. The ZigBee status shows that no network is defined. You can now perform maintenance or change the network settings.
3. In the **Activate ZigBee** field, select **Yes**.
4. In the **Create New ZigBee network** field, select **Yes**.
5. Follow step 6 through to the end of [ZigBee Network Settings on page 56](#) to complete the setup.

Security

Security displays the Com'X 510 firewall settings as well as the HTTPS security certificate currently in use. You can configure the firewall, upload a certificate provided by your network administrator, and control HTTPS redirection.

Firewall Management

Port Settings

Firewall Management allows you to enable or disable the ports and configure port numbers per interface, except where noted.

Below are the default **Firewall Management** settings for each protocol per interface.

	Ethernet 1	Ethernet 2	Wi-Fi	GPRS/3G
HTTP	80, Enabled	80, Enabled	80, Enabled	80, Disabled
HTTPS	443, Enabled ⁽¹⁾	443, Enabled ⁽¹⁾	443, Enabled	443, Disabled
Modbus TCP	502, Disable	502, Enabled	502, Enabled	502, Disabled
⁽¹⁾ Status and port number are not editable.				

Upstream Network Access

In **Firewall Management**, you can also enable upstream network access. This allows downstream devices to access servers (such as DNS, SNTP, and SMTP) on the upstream network.

The table below describes the downstream interface (where the message originated) and the upstream interface on which the message will be forwarded, based on your network selection.

Network Option	Downstream (from)	Upstream (to)
GPRS/3G only	Ethernet Port 2	GPRS/3G
GPRS/3G and switched network	Ethernet Port 2 ⁽¹⁾	GPRS/3G
Wi-Fi only	Ethernet Port 2	Wi-Fi
Wi-Fi and switched network	Ethernet Port 2 ⁽¹⁾	Wi-Fi
2 Switched Ports (1 IP address for both)	Upstream network access not available	
2 Separate Ports (1 IP address for each)	Ethernet Port 2	Ethernet Port 1
⁽¹⁾ Either interface (Ethernet Port 1 or Ethernet Port 2) may be used as the downstream connection when in Switched Mode, but the request will be sent on Ethernet Port 1.		

For example, with the Com'X 510 configured to use two separate Ethernet ports, an IFE connected downstream on Com'X 510 Ethernet Port 2 can send emails to Facility Insights through Ethernet Port 1.

Upstream network access is disabled by default. When enabled, access adapts to the network configuration in **Network Settings**.

Configuring Firewall Settings

To configure firewall settings:

1. Click **Settings > Security > Firewall Management**. Configure each interface by protocol according to the available options above.

NOTE: Editable port numbers can be set to the default value or any port number above 1023.

2. Alternatively, click **Defaults** to reset to defaults.
3. Click **Save changes**.

Disabling the Com'X 510 Password Reset Button

For a Com'X 510 installed in a publicly accessible location, you can disable the password reset function for the **Backup** button , located on the front face of the Com'X 510.

If you lose the default admin password, you must perform a factory reset on the Com'X 510 to reset the password to default. This destroys all logged data, user accounts, and configuration.

NOTICE

IRRECOVERABLE PASSWORD

Record your device's user and password information in a secure location.

Failure to follow these instructions can result in data loss.

We recommend saving a backup configuration before disabling the password reset button.

1. Click **Settings > Security > Firewall Management**.
2. Click **Enable default admin reset**.
3. Click **No** to disable the password reset button.
4. Click **Save changes**.

Certificates

You can view the current HTTPS security certificate, upload a certificate provided by your network administrator to the Com'X 510, and reset to factory default from this page.

Uploading a New Certificate

We recommend creating a backup of your configuration before installing a new certificate. To update the HTTPS certificate:

1. Click inside the text box **Install a new certificate**.
2. In the browser, select your *.pem file, then click **Open**.
3. Click **Install**. The **Installed certificate details** update to display the new certificate.

To remove the current certificate and set the Com'X 510 back to the factory default certificate, click **Reset**.

HTTPS Redirection

<i>NOTICE</i>
<p>UNAUTHORIZED ACCESS</p> <p>Do not disable HTTPS redirection if there is sensitive or private information on your local network.</p> <p>Failure to follow these instructions can result in equipment damage.</p>

HTTPS redirection allows you to secure the communication between PC and Com'X 510 and is enabled by default.

Schneider Electric recommends using **HTTPS Redirection**. Disabling the HTTPS redirection disables your browser security check and compromises the security of your local network.

User Management

User Management allows you to create user groups with configurable permissions for Com'X 510 features. Then you can create individual user accounts and assign each user to a group, based on the desired permissions.

Only an administrator can add, modify, or remove users and groups. See [Group Settings](#) to configure user groups. See [Users](#) to add users.

Group Settings

There are two default user groups: *administrator* and *guest*. You can create additional groups, for example, *Engineering*, *Operations*, or *Maintenance* (see [Creating a Group](#)).

Group permissions are:

- **View**: a group has view-only permission for the selected feature.
- **Modify**: a group has read/write permissions for the selected feature. **View** must also be selected to display the feature in the web view.

The table below describes permissions for each group.

Group	Settings
<i>administrator</i>	Modify for all features. You cannot modify <i>administrator</i> group permissions.
<i>guest</i>	View for selected features. Only an administrator can modify <i>guest</i> permissions.
User-defined	Default access for a new group is view for all features. An administrator must assign permissions.

Group Settings Interface

Below is the interface to add, modify, or delete a group.

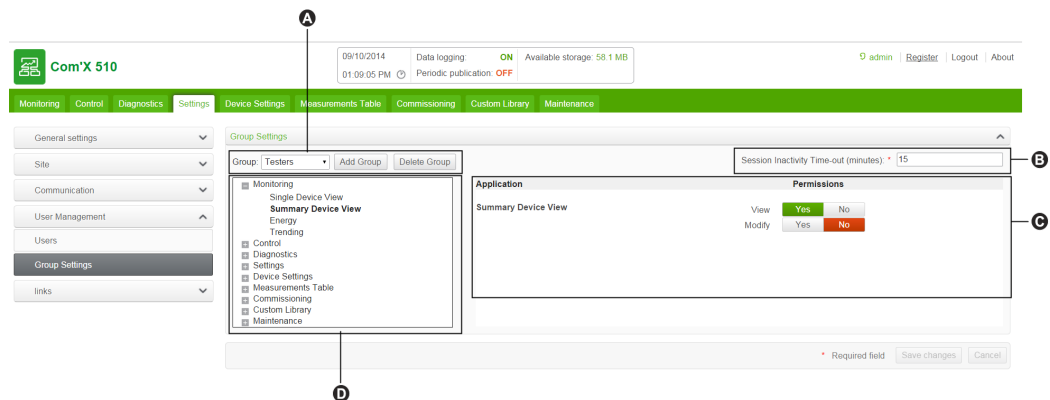

	Parameter	Description
A	Group	List of user groups
B	Session Inactivity Time-out	Period of inactivity (in minutes) after which a user is logged out. Allowable range is 15–240. Default: 15
C	Feature menu tree	List of Com'X 510 features for which you can set permissions
D	Permissions	Determines the level of access users have to each feature: modify, view, or none

Creating a Group

Only an administrator can create a new group. To create a group:

1. Click **Settings > User Management > Group Settings**.
2. Click **Add Group**. A new window opens.
3. Enter the group name, then click **Confirm**. The group is added to the **Group** list.

NOTE: You cannot modify the group name after you create the group.

Default access for a new group is view for all features. See [Modifying Group Settings](#) to configure permissions.

Modifying Group Settings

You cannot modify a group name or the *administrator* group permissions. To modify any other group settings:

1. Click **Settings** > **User Management** > **Group Settings**.
2. Select the group you want to modify from the **Group** drop-down menu.
3. Enter the **Session Inactivity Time-out** interval (in minutes).
4. Select a feature from the feature menu tree to view permissions for that feature.
5. Select **Yes** or **No** for **View** or **Modify** to set permissions.

NOTE: Access to a feature is denied if *No* is selected for **View**.

6. Repeat steps 5 and 6 for each feature.
7. Click **Save changes** to apply the new permissions.

Deleting a Group

You cannot delete a user group if there are any users assigned to that group. Remove users from the group, then follow the steps below.

1. Click **Settings** > **User Management** > **Group Settings**.
2. Select the group you want to delete from the **Group** drop-down menu.

NOTE: You cannot delete the default *administrator* and *guest* groups.

3. Click **Delete Group**, then **Yes** to confirm deletion.

Users

There are two default users: *admin* and *guest*. An administrator can create additional users and assign permissions (see [Group Settings](#)).

The table below describes login credentials for users.

Username	Password	User Group
<i>admin</i>	Default: <i>admin</i> NOTE: After the first time logging in, the user is prompted to change the password.	administrator
<i>guest</i>	Default: <i>guest</i> NOTE: The guest password cannot be modified.	guest
User-defined	An administrator assigns an initial password. The user must change the password after logging in.	User-defined

User Settings

Below is the interface to add, modify, or delete a user.

The screenshot shows the 'Users' management page in the Com'X 510 interface. At the top, there's a status bar with the date '09/10/2014', time '12:54:07 PM', and system status like 'Data logging: ON' and 'Available storage: 58.1 MB'. The navigation menu on the left includes 'General settings', 'Site', 'Communication', 'User Management', 'Users', 'Group Settings', and 'links'. The 'Users' section is active, showing a list of users (A) and a form to add or edit a user (B and C). The form includes fields for 'Login ID', 'Group', 'Password', 'First Name', 'Last Name', and 'Email'. A 'Save changes' button is at the bottom right.

	Parameter	Description
A	Users	List of users for the Com'X 510. The format for users is <i>Login ID (First Name Last Name)</i> .
B	Login Information	<ul style="list-style-type: none"> • Login ID is the unique identifier for the account. • Group determines the permissions you want the user to have. See Group Settings on page 61 to set permissions. • An administrator assigns an initial password.
C	User Information	Includes user's first and last name and email address (optional).

Creating a User

1. Click **Settings > User Management > Users**.
2. Click **New User**.
3. Enter the username and password.

NOTE: An administrator cannot modify the username or password after the user is created.

4. Select a user group from the **Group** drop-down list (see [Group Settings](#)).
5. Enter the user's first name, last name, and email address.
6. Click **Save changes**.

Modifying a User

An administrator cannot modify the username or password after the user is created. If you forget your username or password, contact an administrator to delete the account and create a new one.

To modify any other user settings:

1. Click **Settings > User Management > Users**.
2. Select the user you want to modify.
3. Modify the fields you want to change, then click **Save changes**.

The user must change the password after logging in for the first time. See [Changing the Password on page 21](#).

Deleting a User

If a user is logged in when you delete the account, the user receives a session timeout notification. Any unsaved changes made by the user are lost.

To delete a user:

1. Click **Settings > User Management > Users**.
2. Select the name of the user you want to delete.

NOTE: You cannot remove the default *admin* and *guest* users.

3. Click **Delete User**, then **Yes** to confirm removal.

Events

Events include predefined and custom events that can be sent to Facility Insights. Before configuring events, contact Schneider Electric Facility Insights support to confirm availability of events.

To send events to Facility Insights through DSP, you must enable Schneider Electric Services in **Settings > General Settings > Schneider Electric Services**.

To enable/disable predefined or custom events, click **Settings > Events > Event Settings**.

Predefined Events

Predefined Events are defined by Facility Insights. Enabling Predefined Events allows FI users to send event information from the Com'X 510 to FI. Your Schneider Electric Partner can help you understand how to use these events to signal pre-trip conditions, analyze trips, and schedule periodic maintenance.

Predefined Events cannot be edited or acknowledged from the Com'X 510.

Custom Events

Custom Events allows you to define event conditions using the drag and drop event builder:

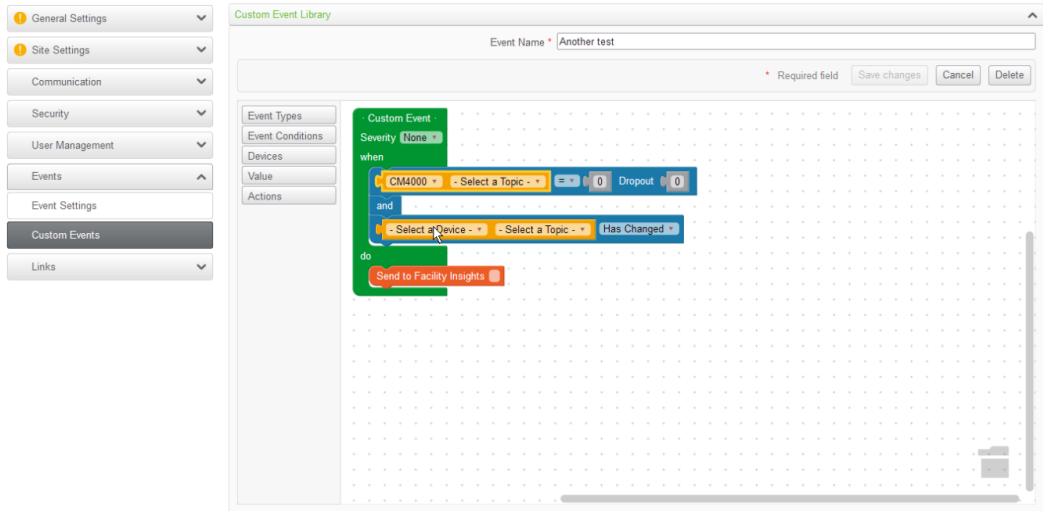

An event consists of the following block elements, found in the event builder menu.

Block Element	Description
Event	Container block for event conditions, actions, and severity level field.
Event Conditions	<ul style="list-style-type: none"> • Threshold: Set one threshold value at which an event occurs. • Pickup/Dropout: Set the value at which an event occurs (pickup) and the value at which the event is no longer active (dropout). Use this type to avoid nuisance events. • Boolean: Create an event when a Boolean topic value changes, is True, or is False, for example, when breaker open status is True. • And: Allows you to combine up to three conditions for an event.
Devices	<p>Select the device and topic that trigger an event. For example, receive a notification when the Temperature on a Temperature Probe Pt100 exceeds 26°C.</p> <p>The device must be connected to the Com'X 510 in Device Settings.</p>
Value	Threshold value for the selected topic.
Actions	<p>Choose an action for the Com'X 510 to perform when the event conditions are met, for example, "Send to Facility Insights."</p> <p>You can enter text in the Action block, for example, the event description. We recommend using the same or similar text as the Event Name field in the Com'X 510.</p>

Creating a Custom Event

Before creating an event, you should be familiar with the device register lists and values.

⚠ WARNING

INACCURATE DATA RESULTS

- Do not incorrectly configure the software, as this can lead to inaccurate reports and/or data results.
- Do not base your maintenance or service actions solely on messages and information displayed by the software.
- Do not rely solely on data displayed in the software reports to determine if the system is functioning correctly or meeting all applicable standards and requirements.
- Do not use data displayed in the software as a substitute for proper workplace practices or equipment maintenance.

Failure to follow these instructions can result in death, serious injury, equipment damage, or permanent loss of data.

To create a new event:

1. Click **Settings** > **Events** > **Custom Events**, then click **New Custom Event**. The event builder displays.
2. Click **Event Types** in the event builder menu, then drag a green event block onto the workspace.
3. Select the event's **Severity**: None, Low (alert), or High (Error).

NOTE: For Facility Insights users, this field corresponds to the severity level in Facility Insights.

4. Click **Event Conditions** in the event builder menu, and drag a conditions block into the "when" space, until it snaps into place.

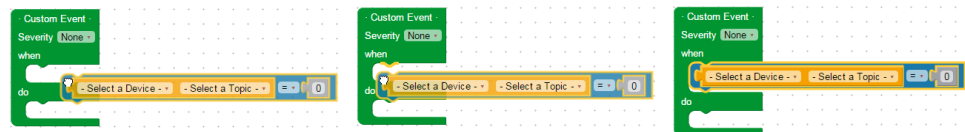

5. Define the **Event Conditions**.
 - a. Select the device and topic.
 - b. For a Boolean event, select a Boolean value: **Has changed**, **True**, or **False**.
 - c. For a threshold or pickup/dropout event, select an operator ($=$, $<$, or $>$) and enter a pickup value. Enter a dropout value if applicable.
6. If the event has more than one condition, add up to two more conditions as described above. Join more than one condition with the "and" logic block.

NOTE: You must choose the same device for each condition in an event.

7. In the Action block, enter a message to be sent to the destination platform (optional).

8. Drag any unused blocks to the trash can in the bottom right corner.
9. Enter a name, then click **Save changes**.

Editing or Deleting a Custom Event

1. Click **Settings > Events > Custom Events**.
2. Click the event name.
3. Either edit the event block and click **Save changes**, or click **Delete** to remove the event from the **Custom Event Library**.

Refer to [Com'X 510 Troubleshooting on page 152](#) if you do not receive the event through the selected **Action**.

Copying an Event

To create a new event from an existing event:

1. Click **Settings > Events > Custom Events**.
2. Click the existing event name.
3. Click on the green event block in the workspace, then press CTRL+C.
4. Click **Cancel** to return to the **Custom Event Library**.
5. Click **New Custom Event**. Click inside the workspace, then press CTRL+V. The event block is pasted into the workspace.
6. Edit the device, topic, or values, then click **Save changes**.

Links

The Com'X 510 supports two types of documentation links:

- Local file access (stored on the Com'X 510)
- External URL access.

The Com'X 510 includes built-in links. These items cannot be edited but can be deleted.

Configuring Links

To add links to the Com'X 510:

1. Click **Settings > Links > Setup Links**. The **Links** page opens.
2. Enter a name and description for the link.
3. Enter a number 1 to 100 in the **Priority** field.

NOTE: Negative priority is reserved for built-in links. Links display in ascending order of priority.

4. Click the type of link, then:
 - a. For **Link to File**, click the to browse for the file.
 - b. For **Link to URL**, enter the URL
5. Click **Add**. The link is added to the setup list and **View Links** (see [Viewing Links on page 69](#))

You can change the type of link after it has been created. To edit a link, click **Edit**, make the desired changes, then click **Update**.

To delete a link, click the check box beside the link name, then click **Remove**.

Viewing Links

To view links, click **Settings > Links > View Links**. Click the link to open the file or web page.

You can click **Setup Links** in the bottom right corner to return to the links configuration page.

Custom Page Management

You can create and add custom web pages to the Com'X 510 to provide building overviews, for example.

This section discusses how to add custom pages to the Com'X 510. For information on APIs and how to create a custom page, see the *Com'X 510 Custom Web Page Technote*, 7EN72-0199.

WARNING

INACCURATE DATA RESULTS

- Do not incorrectly configure the software, as this can lead to inaccurate reports and/or data results.
- Do not base your maintenance or service actions solely on messages and information displayed by the software.
- Do not rely solely on data displayed in the software to determine if the device is functioning correctly or meeting all applicable standards and requirements.
- Do not use data displayed in the software as a substitute for proper workplace practices or equipment maintenance.

Failure to follow these instructions can result in death, serious injury, equipment damage, or permanent loss of data.

Adding a Custom Web Page

The init.js file is required for each web page. Any file referenced by init.js is also required for the page to be valid and viewable.

Before uploading any files, compare the size of the custom page file set with the **Available Storage**.

NOTICE

IMPAIRED COM'X PERFORMANCE

Do not add more than 10 MB of files to Custom Page Management.

Failure to follow these instructions can impair Com'X performance.

1. Click **Settings > Custom Page Management**.
2. Click **Create**, then enter the name you want to display on the web page.
3. Click **OK**. The web page container displays in the list of custom web pages with a validation error.
4. Click **Edit** to add the web page files.
5. Click **Upload**, then select the custom page files from your computer.
6. Click **OK**. The Com'X 510 validates that files called by init.js are present.

To view the newly added web page, you must log out and log in again.

Deleting Custom Web Pages

You can select pages to delete, or you can delete individual files for each page. We recommend removing unused pages.

1. Click **Settings > Custom Page Management**.
2. Select the pages you want to delete, then click **Delete** and **Yes** to confirm.
3. Alternatively, click **Edit** to delete files for a single web page. Select the files you want to delete, then click **Delete** and **Yes** to confirm.

Downloading a Custom Page

You can save a custom web page for use on another Com'X 510 .

1. Click **Settings > Custom Page Management**.
2. Click **Edit** to view the web page files.
3. Select the files you want to download, then click **Download**. Follow your browser's prompts for saving and viewing downloaded files.

Viewing a Custom Web Page

You must be in a user group that has permission to view custom pages. See [User Management on page 61](#) for more information on page permissions.

After you add, edit, or delete custom page content, you must log out and log in again to view the updates. An invalid page is not viewable in Monitoring.

To view a custom page, click **Monitoring > Custom Pages**, then click the name of the page you want to view.

Device Settings

The Com'X 510 supports up to 64 devices. This chapter describes how to manage devices (add, modify, and remove) and view their settings.

⚠ WARNING

INACCURATE DATA RESULTS

- Do not incorrectly configure the software, as this can lead to inaccurate reports and/or data results.

Failure to follow these instructions can result in death, serious injury, equipment damage, or permanent loss of data.

Device Settings Overview

Devices supported by the Com'X 510 are described in the firmware release package. You can also create custom models that are based on custom model types, which have been added to the **Custom Library**.

This graphic shows the **Device Settings** interface that defines the devices connected to the Com'X 510, for example, Ethernet gateways, Modbus meters, pulse meters, or analog sensors:

A	Device tree view
B	Device properties
C	Disconnected devices

D	Action buttons
---	----------------

Device Tree View

The device tree view represents the communication architecture of the installation. The Com'X 510 is always at the top of the tree. Devices are grouped by their connection interfaces: Ethernet ports, Modbus port, digital inputs, and analog inputs.

For digital and analog inputs, each device appears with its **Name** and the input number to which it is connected.

NOTE: The multiple outputs of a main meter (for example, kWh, kVARh pulses) can be connected to several digital inputs.

For Modbus TCP/Modbus serial line gateway, each device appears with its **Name** and its **Slave ID**.

Click a device to display its properties in **General Properties**.

Disconnected Devices

This area displays the devices that are not connected to the installation. Measurements from these devices are not logged.

Device Properties

For a selected device, this zone allows you to:

- define some metadata such as the name, the physical location and, for a meter, the commodity, the energy usage, and the area in the building that is being monitored.
- set up or modify settings such as: the pulse weight for a pulse meter, the slave ID for a Modbus meter, the IP address for a gateway, and the measurements to be logged and published to the selected hosted platform.
- connect and disconnect downstream devices in the drop-down lists when the selected device allows it. Each connection type has its own area. Only devices that can be connected to this type are listed.

This graphic shows the interface of device properties:

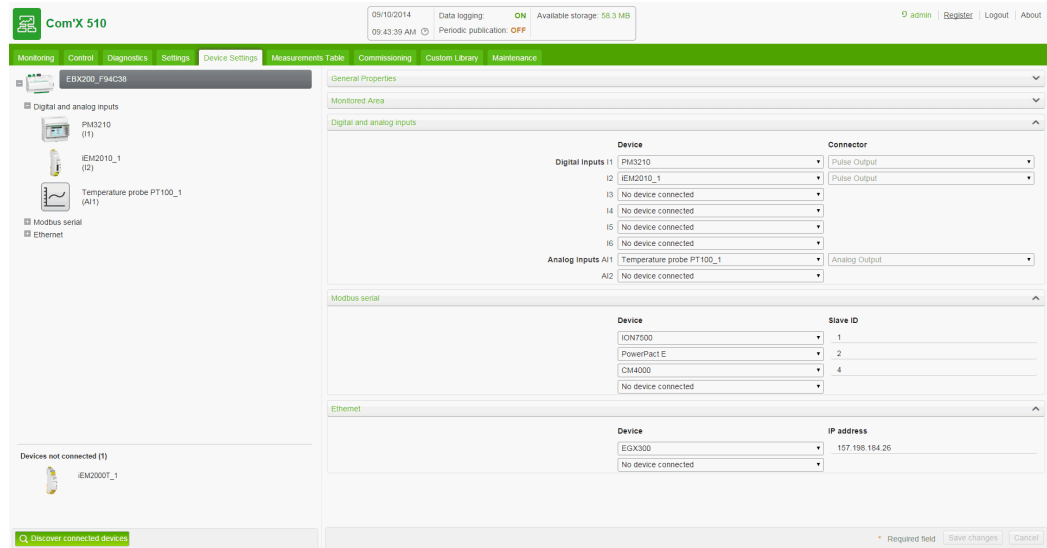

Action Buttons

This table describes the interface buttons:

Button	Action	Availability
Discover connected devices	Launches a Modbus device discovery and automatically retrieves devices that are connected downstream.	Enabled when the Com'X 510 or an Ethernet gateway is selected.
Delete	Removes the selected device. Deletes or moves the devices connected downstream to the Disconnected devices area.	Enabled when a device is selected.
Save changes	Validates the modifications.	Disabled when: <ul style="list-style-type: none"> there is no change in the web page. mandatory fields are left blank. Those fields are highlighted in red. inappropriate characters are entered in a field. This field is highlighted in red.
Cancel	Cancels the modifications to return to the last saved settings.	—

Common Properties

All devices have **General Properties** and **Monitored Area**.

General Properties

All devices have a set of general properties that includes **Type**, **Name**, **Comment**, **Commodity**, and **Device Location**.

This graphic shows the interface of the general properties:

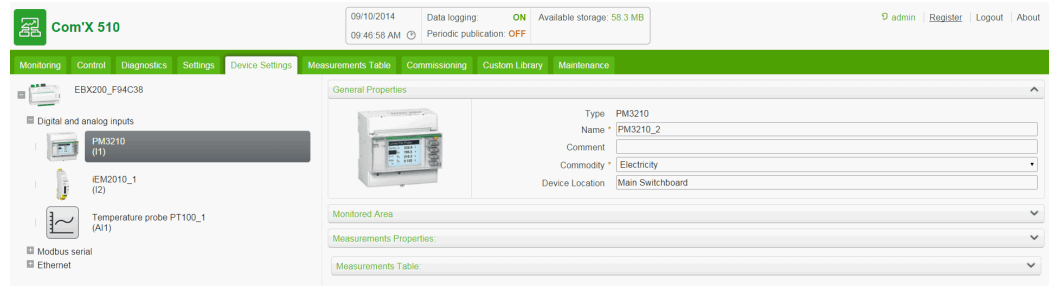

This table presents the general properties of the Com'X 510:

Field	Description	Comments
Type	Corresponds to the device type that is selected.	This field is automatically assigned by the Com'X 510 and cannot be modified.
Name	Corresponds to the name of the device.	This field must not include the following characters: /:*?<> or space.
Comment	Allows you to type additional information.	–
Commodity	Corresponds to the type of measurements.	This field is available only for meters or sensors. The logging interval of measurements is set according to the value defined in Data Logging on page 50 .
Device location	Defines where the device is physically installed.	For example: <ul style="list-style-type: none"> main low voltage switchboard for an electric meter boiler room for a gas meter outdoor north front for a temperature probe

The device name is associated with a measurement to create the meter in Energy Operation. For example, the active energy measurement for a PM3250 named `Ventilation Q01` creates a meter `Ventilation Q01_Active Energy`.

Monitored Area

The graphic shows the monitored area interface:

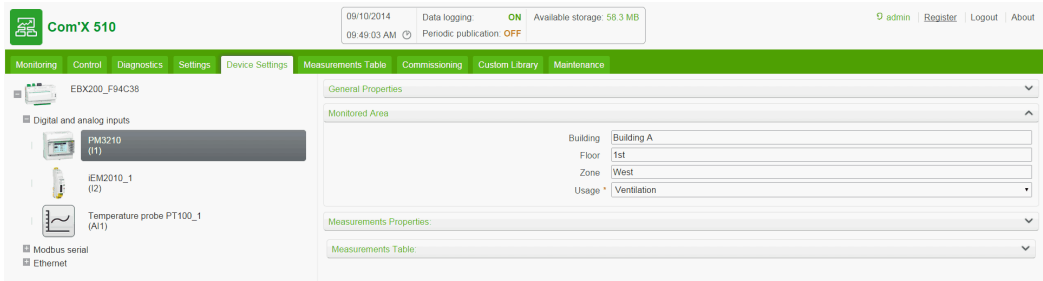

This area enables you to define the building area measured by the meter or sensor. A site can be made up of several buildings. Each building can have several floors. Each floor can be made up of several zones. The site topology is defined by entering values in the **Building**, **Floor**, and **Zone** fields.

The **Usage** field helps identify the device in the **Measurement Table**. You can either use a predefined name or customize your own.

NOTE: To type a floor name, you must enter a building name first. To type a zone name, you must enter a floor name first.

Example: Monitored Area

This example describes how to define the name of the buildings, floors, zones, and usage for the meters or sensors of a site made up of 2 buildings:

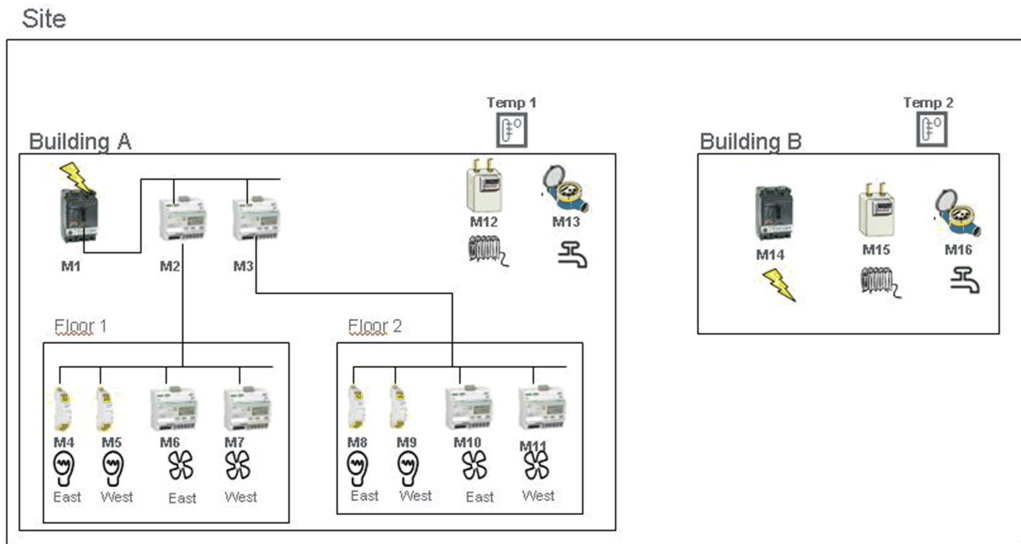

This table shows naming examples for the different fields of the **Monitored Area** collapsible menu:

Meter/Sensor	Device Location	Monitored Area			Usage
		Building	Floor	Zone	
M1	Main switchboard	Building A	–	–	Main meter

Meter/Sensor	Device Location	Monitored Area			Usage
		Building	Floor	Zone	
M2	Main switchboard	Building A	1st	–	Submeter
M3	Main switchboard	Building A	2nd	–	Submeter
M4	Distribution board 1	Building A	1st	East	Lighting
M5	Distribution board 1	Building A	1st	West	Lighting
M6	Distribution board 1	Building A	1st	East	Ventilation
M7	Distribution board 1	Building A	1st	West	Ventilation
M8	Distribution board 2	Building A	2nd	East	Lighting
M9	Distribution board 2	Building A	2nd	West	Lighting
M10	Distribution board 2	Building A	2nd	East	Ventilation
M11	Distribution board 2	Building A	2nd	West	Ventilation
M12	Boiler room	Building A	–	–	Heating
M13	Outdoor	Building A	–	–	Main meter
Temp1	Outdoor north front	Building A	Outdoor	–	Other
M14	Main switchboard	Building B	–	–	Main meter
M15	Boiler room	Building B	–	–	Heating
M16	Outdoor	Building B	–	–	Main meter
Temp2	Outdoor north front	Building B	Outdoor	–	Other

NOTE: Energy Operation retrieves this information from the Com'X 510 to create the metering site architecture.

Manage Devices

Managing devices includes:

- [Adding a Downstream Device on page 78](#)
- [Modifying a Device on page 79](#)
- [Disconnecting a Device on page 79](#)
- [Reconnecting a Device on page 80](#)
- [Replacing a Device on page 80](#)
- [Deleting a Device on page 81](#)

Adding a Downstream Device

Follow this procedure to add a downstream device:

1. Click the **Device Settings** main tab.
2. In the device tree view, click the upstream device to which the downstream device is connected. For example, select the Com'X 510 to connect a device to the Com'X 510.
3. Click the collapsible menu that corresponds to the type of device to be connected:
 - **Digital and analog inputs** collapsible menu for devices connected to the Com'X 510 digital and analog inputs, for example, pulse meters or analog sensors.
 - **Modbus Serial** collapsible menu for a Modbus device. Modbus can also be automatically discovered with the **Discover connected devices** button (see [Discovering Connected Devices on page 164](#)).
 - **Ethernet** collapsible menu for a Modbus TCP/Modbus serial line gateway or IP-enabled device.
4. Select **Create a new device** in the **Device** drop-down list.
5. Select the type of device to be created in the **Device Type** drop-down list.

NOTE: Only the devices that can be connected to this interface are listed. You cannot modify the device type after the device has been created.
6. Configure the device. Refer to the sections that correspond to the device category:
 - [Adding a Digital Input on page 161](#)
 - [Adding an Analog Input on page 163](#)
 - [Adding a Schneider Electric Modbus Serial Device on page 164](#)
 - [Ethernet Device Configuration Parameters on page 90](#)
7. Click **Create** and the device appears in the device tree view.

Modifying a Device

Follow this procedure to modify a device setting:

1. Click the **Device Settings** main tab.
2. Click the device in the device tree view.
3. Modify the settings in the required collapsible menu.
4. Click **Save changes**.

NOTE: The device type cannot be modified. If a device is incorrectly configured, delete the device and create a new one.

Disconnecting a Device

Follow this procedure to disconnect a device from an upstream device:

1. Click the **Device Settings** main tab.
2. Click the parent device in the device tree view.

3. Select **No device connected** in the **Connected to** drop-down list. The device appears in the **Devices not connected** collapsible menu under the device tree view.
4. Click **Save changes**.

NOTE: The device does not appear in the **Measurements Table**. No measurement from this device is sent to the hosted platform. The device is still available in Real Time Data.

Reconnecting a Device

Follow this procedure to reconnect a device from an upstream device:

1. Click the **Device Settings** main tab.
2. In the device tree view, click the upstream device to which the downstream device must be connected. For example, select the Com'X 510 to reconnect a device to the Com'X 510.
3. In the **Digital and analog input** collapsible menu, select the device to be reconnected on the required digital input.
4. Click **Save changes**.

Replacing a Device

Follow this procedure to replace an existing device with another device of a similar type. This procedure can be used to replace a standard device with a custom device without losing the properties of the original device.

1. Click the **Device Settings** main tab.
2. In the device tree view, click the upstream device to which the device to be replaced is connected. For example, select the Com'X 510 to replace a device connected to the Com'X 510.
3. Click the collapsible menu that corresponds to the type of device to be replaced:
 - **Digital and analog inputs** collapsible menu for devices connected to the Com'X 510 digital and analog inputs (for example, pulse meters or analog sensors).
 - **Modbus Serial** collapsible menu for a Modbus device. Modbus can also be automatically discovered with the **Discover connected devices** button ([Discovering Connected Devices on page 85](#)).
 - **Ethernet** collapsible menu for a Modbus TCP/Modbus device.
 - **ZigBee**: Replacing a ZigBee device launches the ZigBee Devices discovery function (see [ZigBee Device Discovery on page 91](#)). The discovery is stopped when the first ZigBee device is found. If several ZigBee devices are near to each other, the first ZigBee device found might not be the one you want. In this case, repeat the procedure.
4. Select the device you want to replace.

NOTE: Select a replacement device that is of the same (or similar) type and that supports the same published measurement data as the original device.

5. Click **Replace** at the bottom of the **Device Settings** main tab. The **Replace device** dialog opens.
6. In the **Replace device** dialog, select the replacement device type and click **Replace**.

NOTE: When you replace an existing device, the replacement device will display the previous device **Name** unless you edit the name.

7. If necessary, edit the **Name** and other settings for the replacement device, then click **Save changes** at the bottom of the **Device Settings** main tab.

Deleting a Device

Follow this procedure to delete a device:

1. Click the **Device Settings** main tab.
2. Click the device to be deleted in the device tree view.

NOTE: Do not deactivate the ZigBee network when removing ZigBee devices.

3. Click **Delete** to confirm the deletion of the device.

Measurement and Metadata Exported Per Hosted Platform

This table summarizes the exported data per hosted platform:

Measurement/Metadata	Energy Operation	CSV Export	Digital Service Platform
Customer ID	–	–	–
Site name	X	X	X
Device name	X	X	X
Selected measurement	X	X	X
Commodity	X	–	X
Monitored area parameters			
Building	X	–	X
Floor	X	–	X
Zone	X	–	X
Usage	X	–	X

Selecting Measurements to Log or Publish

It is important to consider how much data is being logged across all devices when selecting the logging interval and number of topics to log. Logging too many topics per interval may affect Com'X 510 performance, including degraded web page response and missed logging intervals.

For example, for a logging interval of less than five minutes, we recommend that you log no more than 8 devices with 50 total topics.

This graphic shows the measurement table interface:

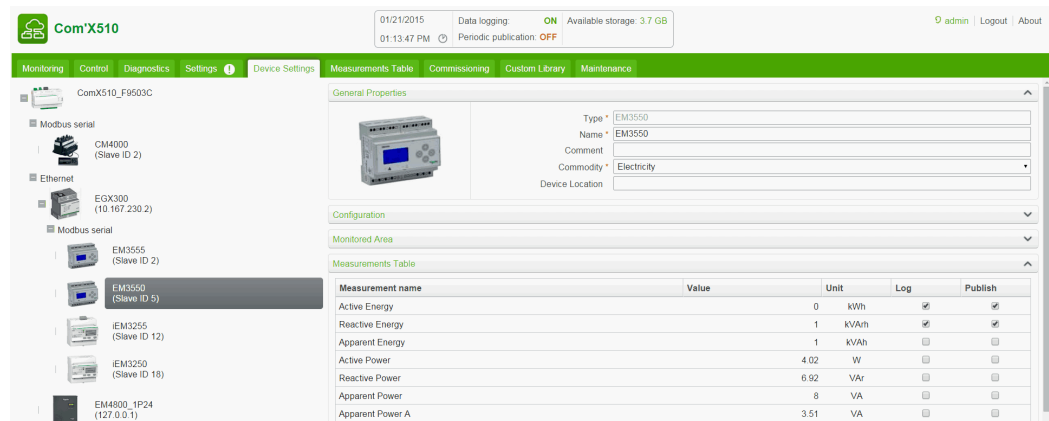

Follow this procedure to select measurements to log and publish to a platform:

1. Click the **Device Settings** main tab.
2. Click the meter or sensor in the device tree view.
3. Click the **Measurements Table** collapsible menu.
4. Select the **Log** check box of the measurement to be logged.
5. Select the **Publish** check box to send the data to the platform selected in [Selecting Platform and Publication Frequency on page 41](#) (optional).
6. Click **Save changes**.

Factory Settings of the Measurement Table

These measurements are selected by default:

Device Type	Measurement
Pulse meter	<ul style="list-style-type: none"> • Index
Contactors/Impulse relay	<ul style="list-style-type: none"> • Status • Run hours

Device Type	Measurement
Electric utility meter	<ul style="list-style-type: none"> Active energy Reactive energy
Power meter	<ul style="list-style-type: none"> Active energy Reactive energy
Resistance Temperature Detector (RTD)	Temperature
0–10 V/4–20 mA analog sensors	Analog value

Notification Icons

Icon	Description
	This icon indicates that no measurement can be retrieved from this device.

Devices That Can Connect to Digital Inputs

Devices with digital inputs are: the Com'X 510, the Acti 9 Smartlink, and the SIM10M.

This section describes pulse meters supported by the Com'X 510 (see [Built-In Pulse Meters on page 83](#)) and custom pulse meters (see [Custom Pulse Meter on page 84](#))

Built-In Pulse Meters

Measurement Properties

This graphic shows the interface of the measurement properties of a built-in Schneider Electric pulse meter:

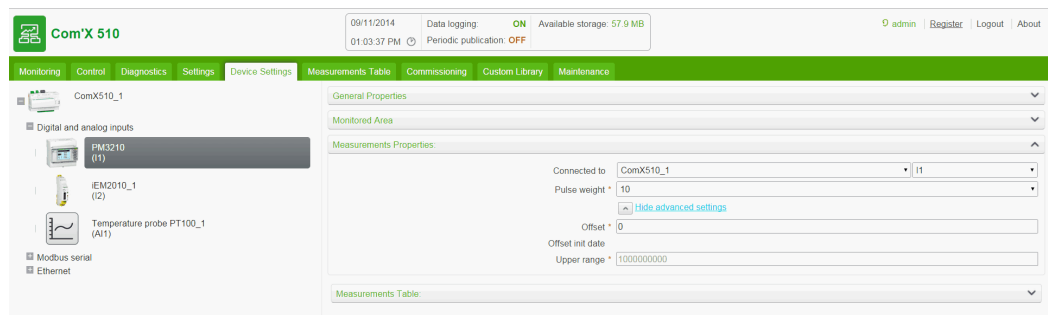

This table describes the measurement properties of a built-in Schneider Electric pulse meter:

Field	Description	Comment
Connected To	Displays the upstream device and the digital input number to which the device is connected. The digital input number can be modified. Only the available digital inputs of the upstream device are listed.	The device can be disconnected by selecting No device connected in the list of upstream device. From this list, it is not possible to change from 1 upstream device to another.
Pulse weight	The active energy counter increases by this value each time a pulse is received. The list is restricted to the values that correspond to the selected meter type.	The value cannot be modified if there is only 1 possible pulse weight, for example with the iEM2000T meter. ⁽¹⁾
Offset	Sets an offset for the active energy. The value can be positive or negative.	Enables you to start the counter with the value that can be read on the meter display.
Upper Range	Defines when the active energy counter rolls back to zero.	The counter sets back to zero when it reaches the entered value.

(1) Refer to the specific pulse meter documentation for further information.

Measurement Table

This graphic shows the interface of the measurement table for a Schneider Electric pulse meter:

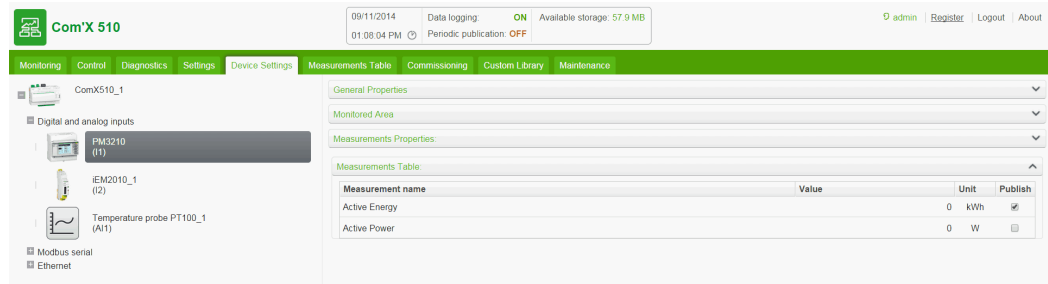

The active power is calculated according to the frequency of received pulses.

Custom Pulse Meter

You can add a pulse meter that is based on a custom pulse meter model. Before adding a custom device, you first need to create the custom model ([Custom Models on page 115](#)) in the **Custom Library**.

Devices That Can Connect to Analog Inputs

The devices with analog inputs are the Com'X 510 and the SIM10M.

This section describes resistance temperature detectors supported by the Com'X 510 (see [Resistance Temperature Detectors on page 85](#)) and custom analog devices (see [Custom Analog Devices on page 85](#))

Resistance Temperature Detectors

Measurement Properties

The Pt100/Pt1000 Resistance Temperature Detectors (RTD) are sensors used to measure temperature by correlating the resistance of the RTD element with temperature.

The RTD can only be connected to the analog inputs of the Com'X 510.

The temperature range is from $-50\text{ }^{\circ}\text{C}$ ($-58\text{ }^{\circ}\text{F}$) to $+104\text{ }^{\circ}\text{C}$ ($219\text{ }^{\circ}\text{F}$).

When connecting an RTD probe to the Com'X 510, there are no specific parameters to configure.

Measurement Table

By default, the temperature is logged and published to the selected platform.

Custom Analog Devices

You can add an analog device that is based on a custom analog device model. Before adding a custom device you first need to create the custom model ([Custom Models on page 115](#)) in the **Custom Library**.

Modbus Devices

This section includes:

- [Discovering Connected Devices on page 85](#)
- [Adding a Modbus Device Manually on page 87](#)
- [Connecting Devices to Acti 9 Smartlink on page 89](#)

Discovering Connected Devices

With the **Modbus discovery function**, the Com'X 510 can discover the devices that are locally connected to their Modbus serial port and downstream Modbus TCP/Modbus serial line gateways.

This graphic shows the **Modbus Discovery** interface:

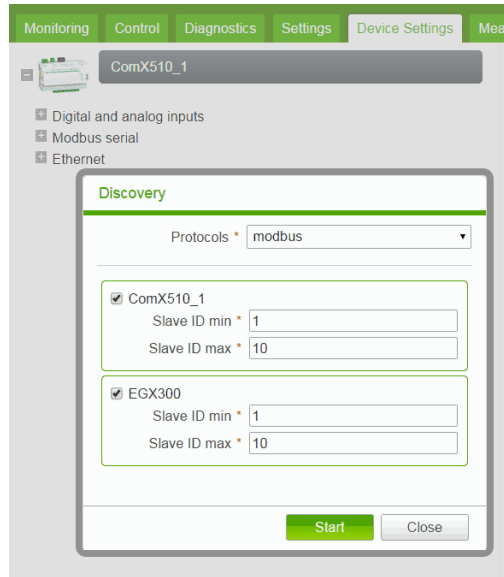

Follow this procedure to discover connected Modbus devices:

1. Click the **Device Settings** main tab.
2. Click the Com'X 510 in the device tree view. Or, click the gateway in the device tree view to discover only the downstream devices connected to a gateway such as an EGX.
3. Click **Discover connected devices** to open the **Modbus Discovery** window.
4. Enter a **Slave ID min** and **Slave ID max**. The default range is 1 to 10, and the allowable range is 1 to 247.
5. Click **Start** to discover the devices. Discovered devices are listed in the **Modbus Discovery** window. Click **Stop** if you want to stop the **Modbus Discovery** process.
6. Deselect any devices you do not want to add, then click **Create**. The **Modbus Discovery** window closes and all the discovered devices appear in the device tree view as follows:
 - If a device was created using a built-in model, the application automatically associates the device with the appropriate model.
 - If a device was created from a custom model that was added to the Custom Library, the application associates the device with the first model in the custom device list. In this case, you need to select the appropriate custom model for the device in the device type list.

Modbus Discovered Status

This table presents the discovered status of the device:

Message	Description
OK	The device is discovered and supported by the Com'X 510.
This device is already connected	The device has been discovered from a previous Modbus discovery or by manual entry. It is supported by the Com'X 510.

Message	Description
Unknown device	The device has been discovered but it is not supported by the Com'X 510. This occurs if the device is a custom device, and no custom models have been created in the Custom Library .
No device discovered	No device is connected to this Modbus address (slave ID).

NOTE: Refer to [Modifying a Device on page 79](#) to change the device settings.

Adding a Modbus Device Manually

Modbus devices that are not connected cannot be discovered, but they can be added manually using the following procedure. You can add either a built-in Modbus device or a custom Modbus device that you have previously created in the **Custom Library**.

This graphic presents the interface when adding a Modbus device manually:

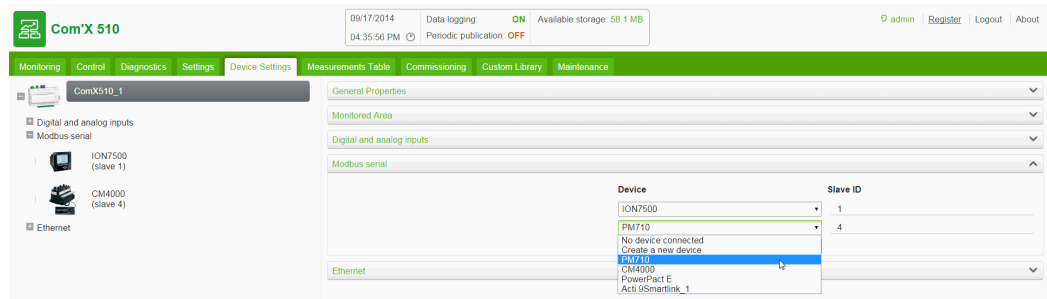

Follow this procedure to add a Modbus device manually:

1. Click the **Device Settings** main tab.
2. Select the upstream device with a Modbus serial port in the device tree view.

For example, the Com'X 510 must be selected to connect a Modbus device to the Com'X 510.

3. Select the **Modbus Serial** collapsible menu. Click the header to expand the **Modbus Serial** collapsible menu.
4. Click **Create a new device** in the **Device** drop-down list.
5. Select a **Device Type** in the drop-down list.

NOTE: Only the devices that can be connected to a Modbus serial port are listed.

6. Type the **Slave ID** in the **Configuration** collapsible menu. Refer to [Common Properties on page 75](#) for completing the other parameters.
7. Click **Create** and the device appears in the device tree view.

Connecting Devices to WT4200 Modbus Receiver

The WT4200 Modbus Receiver is a Modbus interface between the Com'X 510 and the WT4200 radio transmitters.

Each transmitter is seen as a different channel for the WT4200 Modbus Receiver.

You must configure the WT4200 Modbus Receiver before adding it to the Com'X device list and connecting transmitters. WT4200 configuration determines to which channel the transmitter can be added. Refer to the *PowerLogic WT4100 series / WT4200 series long-range RF wireless devices user manual* for wireless receiver programming instructions.

⚠ WARNING

INACCURATE DATA RESULTS

The configuration in the Com'X 510 must be consistent with the configuration in the WT4200 Modbus receiver.

Failure to follow these instructions can result in death, serious injury, or equipment damage.

This graphic presents the general properties interface for connecting devices to the WT4200 Modbus Receiver:

General Properties ^



Type RadioTech 001 - 014

Name* RadioTech 001 - 014

Comment

Device Location

Configuration ^

Slave ID* 1

Monitored Area ^

Building

Floor

Zone

Channel 1 ^

	Device	Connector
C1_1	RadioTech temperature transmitter	Temperature
C1_2	ME3ZR	Pulse Output

Channel 2 v

Channel 3 v

Follow this procedure to connect devices to the WT4200 Modbus Receiver:

1. Click the **Device Settings** main tab.
2. Click the WT4200 in the device tree view.

3. In the **Channel** collapsible menu, select the channel (C1, C2, and so on) to which the device is connected. Click the header to expand the channel area.
4. Select **Create a new device** in the appropriate digital input dropdown list.
5. Select the type of device to be created from the dropdown list. Only the devices that can be connected to this interface are listed. You may need to create your own custom device (see [Custom Library on page 115](#)).
6. Configure the device. Refer to the sections that correspond to the specific device category (see [Devices That Can Connect to Digital Inputs on page 83](#)).
7. Click **Create** and the device appears in the device tree view downstream from the WT4200.

Connecting Devices to Acti 9 Smartlink

The Acti 9 Smartlink is a remote I/O module. It transmits data from an Acti 9 System to the Com'X 510, the EGX100, or the EGX300 through the Modbus serial line communication network.

The Acti 9 Smartlink Modbus RS485 is made up of 11 channels. Each channel includes two digital inputs and one digital output.



This graphic presents the general properties interface for connecting devices to the Acti 9 Smartlink:

Follow this procedure to connect devices to the Acti 9 Smartlink:

1. Click the **Device Settings** main tab.
2. Click the Acti 9 Smartlink in the device tree view.
3. In the **General Properties** collapsible menu, select the channel (C1, C2, and so on) to which the device is connected. Click the header to expand the channel area.

4. Select **Create a new device** in the chosen drop-down list. The two drop-down lists correspond to the C1_I1 or C1_I2 digital inputs.
5. Select the type of device to be created from the drop-down list.

NOTE: Only the devices that can be connected to this interface are listed: Schneider Electric pulse meters, utility meters, contactors, and impulse relays. You may need to create your own custom device.

6. Configure the device (see [Devices That Can Connect to Digital Inputs on page 83](#)).
7. Click **Create** and the device appears in the device tree view downstream from the Acti 9 Smartlink.

NOTE: If using the prefabricated cable associated with the contactor iACT24 or impulse relay iATL24, the device must be connected on the digital input 1 of the channel. This input provides the status of the device.

Ethernet Devices

This section includes:

- [Built-in Ethernet Devices on page 90](#)
- [Ethernet Device Configuration Parameters on page 90](#)
- [Custom Ethernet Devices on page 91](#)

Built-in Ethernet Devices

In the system, you can add these devices:

- Modbus TCP/IP to Modbus serial line gateways. These gateways are used to collect data from serial devices.
- Modbus TCP/IP meters.
- Custom Modbus TCP/IP to serial gateway used to collect data from serial devices.

NOTE: To collect data from a PM800 series meter with an Ethernet card and use this PM800 as a gateway, you must define 2 devices: the meter (for example, PM850ECC) and the gateway (PM8ECC Modbus gateway).

Ethernet Device Configuration Parameters

This graphic presents the interface to configure Ethernet devices:

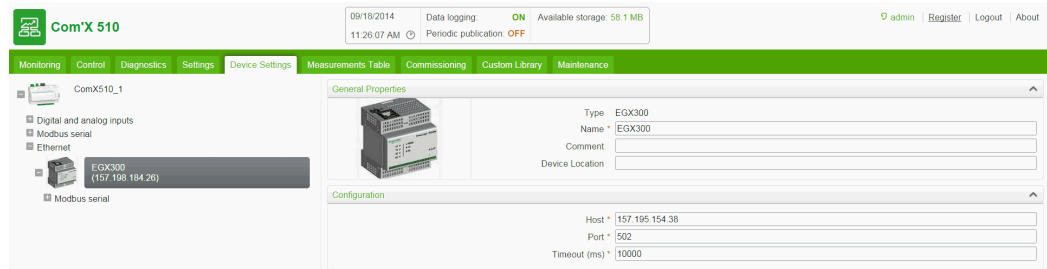

This table shows how to configure Ethernet devices:

Field	Description
Host	Defines the IP address of the device.
Port	Defines the port number. 502 is used for Modbus.
Slave ID	Gives the address only for Modbus TCP meters or devices.
Local ID	The address to use when accessing data from a device by an external client. The Local ID must be unique. This configuration parameter can only be changed if data logging is disabled for the device being updated. See Starting the Data Logging on page 96 .

Custom Ethernet Devices

You can add an Ethernet device that is based on a custom Ethernet model. Before adding a custom device, you first need to create the custom model ([Creating a Custom Model on page 115](#)) in the **Custom Library**.

ZigBee Device Discovery

With the ZigBee discovery function, the Com'X 510 can discover ZigBee devices that are within range.

Discovering Devices

Do not launch the ZigBee discovery mode of several Com'X 510 simultaneously. If you have two or more ZigBee networks in discovery mode, the ZigBee devices are installed randomly on these networks.

Follow this procedure to discover connected ZigBee devices:

1. Click the Com'X 510 in the device tree view.
2. Click Discover devices to open the Discovery window.
3. Select the communication protocol ZigBee.

4. Enter the Timeout time (in minutes).
5. Click Start to discover the devices. Discovered devices are listed in the ZigBee Discovery window. Click Stop if you want to stop the ZigBee Discovery process.

NOTE: In order to detect the ZigBee devices, you also need to activate the discovery mode on the different devices.

6. Close the ZigBee Discovery window. All the discovered devices appear in the device tree view.

A **Local ID** is automatically assigned whenever a device is created. You can change the **Local ID** in **Settings > Communication > Modbus Gateway > Device IDs**.

Measurements Table

The **Measurements Table** allows you to view all the meters and sensors of the system that log data.

Only the data that has been selected for logging is present in the **Measurements Table**.

Viewing the Measurements Table

Meters are grouped by commodity. This graphic shows the interface of the **Measurements Table**:

The screenshot displays the Com'X 510 web interface. At the top, there is a header with the date 09/18/2014, time 09:07:42 AM, and system status (Data logging: ON, Available storage: 58.3 MB). A navigation menu includes Monitoring, Control, Diagnostics, Settings, Device Settings, Measurements Table (selected), Commissioning, Custom Library, and Maintenance. Below the menu, a 'Filter by Commodity' section allows users to select various commodity types: Electricity (checked), Water, Gas, Air, Steam, Environmental parameters (checked), and Other (All / None). The 'Electricity' section is expanded, showing four meter cards with the following data:

Commodity	Meter ID	Device Name	Building	Floor	Zone	Active Energy	Reactive Energy
Electricity	EM2010	EM2010_1	Main meter			0 kWh	
Electricity	PM3210	PM3210	Main meter			0 kWh	
Electricity	PM320	PM320	Main meter			203.51 kWh	113.25 kVArh
Electricity	PM710	PM710	Computer room	2	west	203.51 kWh	

The 'Environmental parameters' section is also expanded, showing a 'Temperature probe PT100' card with a Temperature value of 0 °C.

To view all the meters and sensors:

1. Click the **Measurements Table** main tab.
2. Select the required meters in the **Filter by commodity** field:
 - Click **All** to visualize all the commodities at the same time.
 - Click **None** to hide all the commodities at the same time.
 - Check the corresponding check box to view all the measurements of a commodity.
 - Uncheck the corresponding box to hide all the measurements of a commodity.

Commissioning

Commissioning allows you to:

- check that configuration is completed.
- start/stop data logging.
- send the metering architecture to Energy Operation. This option is available only if Energy Operation is selected as the publication platform.
- export the logged data manually to the selected hosted platform.
- start the periodic publication of data to the selected hosted platform.

Commissioning Interface

This graphic presents the commissioning interface:

This table shows commissioning fields:

Field	Description
Notifications	Displays the status of the configuration process. If any requested field or parameters are missing, a link to the corresponding tab is displayed. Click the link to be redirected to the tab.

Field	Description
Data logging	<p>Displays a button to start data logging. The button is disabled if:</p> <ul style="list-style-type: none"> the configuration is not complete. there is no selected data to be logged. <p>See Starting the Data Logging on page 96 for more information.</p>
Topology⁽¹⁾	<p>Sends the metering architecture to Energy Operation. This creates the metering hierarchy in Energy Operation. This option is available only if Energy Operation is selected as the publication platform.</p> <p>If you do not send the topology to Energy Operation, all measurements will appear under the site named <code>Site Newmeters</code>.</p>
Publication	<p>Allows you to export the logged data manually to the hosted platform. See Starting the Publication on page 97.</p>
Status console	<p>Displays the successive steps with the corresponding status when the publication is launched, from the construction of the data file to the delivery of the file on the database server.</p> <p>Refer to the maintenance logs (see Logs on page 137) if an error occurs during publication.</p>
<p>⁽¹⁾ If you change the topology of the Com'X 510 or modify the Com'X 510 configuration by adding some measurement values or meters after the first publication, do not use the Send Topology button. Contact local Schneider Electric technical support.</p>	

Starting the Data Logging

Before you can log data, you must:

- complete configuration of the Com'X 510.
- configure the devices that you want to log data (see [Manage Devices on page 78](#)).
- select the data to be logged (see [Selecting Measurements to Log or Publish on page 82](#)).

To enable data logging:

- Click **Commissioning > Data Logging**.
- Click **Start data logging**. The date and time that logging is initiated are displayed.

To disable data logging, click **Commissioning > Data Logging > Stop data logging**.

Starting the Publication

If you are publishing data to Energy Operation, you must send the topology to Energy Operation as in [Publishing the Data to Energy Operation on page 166](#)

After you have configured devices for publishing:

1. Click the **Test publication** button to send data to the hosted platform.
2. Click the **Start periodic publication** button to send data to the hosted platform according to the frequency set in **Publication settings**.

Monitoring

The Com'X 510 provides views of real-time data and trends along with historical data log trends and dashboards. Data from devices on digital and analog inputs are not available in the **Monitoring** tab.

Real Time Data

Real Time Data provides basic readings of selected devices in real time, as well as device summaries.

Single Device View

Single Device View displays the following information for the selected device.

Menu	Description
Monitored Area	Parameters describing the location and use of the device as defined in Common Properties on page 75
Gauges	Analog view of device readings. Options are <i>Load Current (A)</i> , <i>Power</i> , <i>Voltage LL</i> , and <i>Voltage LN</i> .
Basic	Most common readings for the selected device.
Energy	Table view of energy data.
Demand	Table view of power demand data.
Power Quality	Table view of power quality data.

Below is the user interface for the **Single Device View**:

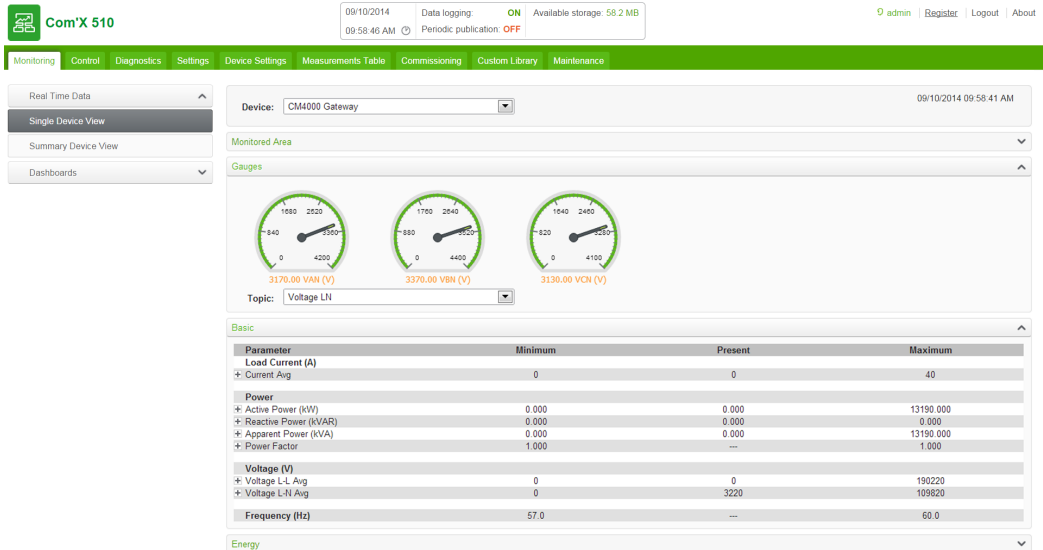

Viewing Real Time Data for a Single Device

To view data for a single device:

1. Click **Monitoring > Real Time Data > Single Device View**.
2. Select a device from the **Device** drop-down list. The gauges display data from the selected device.
3. Click the expandable menus to view each set of data described in [Single Device View](#).

Summary Device View

Summary Device View provides summaries of one or more selected devices. The measurements displayed in each summary are listed below.

Summary	Measurement
Circuit	<ul style="list-style-type: none"> • Demand RMS Current (A) • Real Power (kW) • Power Factor • Breaker Status
Load Current	RMS Current per phase (A)
Demand Current	RMS Demand Current per phase (A)
Power	<ul style="list-style-type: none"> • Present Demand (kW) • Peak Demand (kW) • Recorded Time and Date

Summary	Measurement
Energy Delivered	<ul style="list-style-type: none"> • Real Energy Delivered (kWh) • Reactive Energy Delivered (kVARh) • Real Energy Total (kWh) • Reactive Energy Total (kVARh)
Energy Received	<ul style="list-style-type: none"> • Real Energy Received (kWh) • Reactive Energy Received (kVARh) • Real Energy Total (kWh) • Reactive Energy Total (kVARh)
Power Quality	<ul style="list-style-type: none"> • Power Factor Total • Frequency (Hz) • THDVLL (V) • THDVLN (V)

Viewing a Device Summary

To view a device summary table:

1. Click **Monitoring > Real Time Data > Summary Device View**.
2. Select the summary you want to view.
3. Select the device(s) from the **Device Selection** list. The requested data displays.

For the current session, the selected settings are maintained if you navigate away from Summary Device View.

Real Time Trending

Real Time Trending allows you to view and save (image or .csv file) data points from multiple devices and/or topics in real time.

Viewing a Real Time Trending Graph or Table

To view a real time trend of multiple devices and topics:

1. Click **Monitoring > Real Time Data > Real Time Trending**.
2. Select devices from the **Available Devices** list, then select a topic(s) from the **Available Topics** list.

NOTE: Only topics common to all selected devices are available for trending. The maximum number of topics to trend is dependent on the number of devices selected. The product of the selected devices and topics must be 9 or less.

3. Select the axis update method:
 - **Fixed** adds data points left to right and the x-axis stays constant.
 - **Auto** re-plots data points and redraws the x-axis after each sample.
4. Choose a trend duration of 1 to 15 minutes.

NOTE: Data samples are taken at a one-second rate but may take longer depending on the communications load on the serial sub-net and/or remote devices.

5. Click **Start Sampling**. The graph begins to update.
6. You can stop trending before reaching the trend time by clicking **Stop Sampling**. If you press **Start Sampling** again, a new trend is started.
7. Click **VIEW POINTS** to see the data in a table format.

During the sampling, you can change the axis and line type, as well as navigate away from **Real Time Trending**. The [session inactivity time-out](#) interval begins after the sample is complete or stopped.

Saving Real Time Trending Data Points or Graph

After the trending interval is complete or you have stopped sampling, you can export the data to a .csv file or save the graph as an image.

1. Click **EXPORT DATA**, then follow your browser's prompts for saving the file. Alternatively, click **VIEW POINTS**, then click **Export Data**.
2. To save the graph as an image, right-click the graph, then click **Save image as**. Follow your browser's prompts for saving the file.

Dashboards

There are two types of dashboards: **Energy** and **Historical Trending**.

Energy dashboards display energy consumption information aggregated over time.

The Com'X 510 supports the four periods for energy dashboards described below.

Period	Description
Day over Day	By default, displays previous day over current day by hours.
Week over Week	By default, displays previous week over current week by days.
4 Weeks over 4 Weeks	By default, displays previous four-week period over current four-week period. NOTE: Months are aligned by day of the week, not day of the month.
Year over Year	By default, displays previous calendar year over current year by months.

Historical Trending displays each data point collected for the devices/topics and timeline chosen.

Viewing a Dashboard Graph or Table

To view a dashboard:

1. Click **Monitoring > Dashboards**.
2. Click a dashboard category: **Energy** or **Historical Trending**.
3. Select a device from **Available Devices**, then select a topic from **Available Topics**.

NOTE: For **Historical Trending**, you can choose a single device with multiple topics (max 12) or multiple devices (max 4) with a single topic.

4. Select the dashboard **Period** (Energy only). The requested graph displays.
5. Optionally, you can refine the dashboard:
 - a. Click the calendar icon  to select a new start date for the **Period**. For **Historical Trending**, you can also select an end date to display up to 92 days.
 - b. Select the type of graph.
 - c. Click the divider between the device list and the graph to collapse the selection area and increase the dashboard's display area.
6. Click **VIEW POINTS** to see the data in a table format.

You can hover over a data point to view the value, date, and time. See [Using the Dashboard Kiosk on page 104](#) for a full-screen dashboard view.

NOTE: The graph updates only if the **Period** includes the current day. Otherwise, the dashboard remains static.

Saving Dashboard Data Points or Graph

You can save data from a dashboard (Energy or Historical Trending) as a .csv file or as an image, as shown in the steps below.

1. View the dashboard as in [Viewing a Dashboard Graph or Table on page 102](#).
2. Click **EXPORT DATA**, then follow your browser's prompts for saving the file. Alternatively, click **VIEW POINTS** to preview the data, then click **Export Data**.
3. To save the graph as an image, right-click the graph, then click **Save image as**. Follow your browser's prompts for saving the file.

Saving a Dashboard Link

You can save a dashboard link to avoid having to select from the main menu each time you access the dashboard. This table describes the methods for saving a dashboard link.

Option	Description
Browser Bookmark	Allows users to access the saved dashboard on the computer where the bookmark is created. Follow instructions for setting a bookmark in your preferred browser.

Option	Description
Documentation Link	Allows all users to access a saved dashboard from the Links page. See Links on page 68 for setting URL access.
Messaging	Allows users to paste a dashboard URL in the body of an email, SMS, or other messaging medium. Email recipient must have a user account with at least View access for Dashboard . See User Management on page 61

Using the Dashboard Kiosk

A user in a group with any modify permissions is subject to the **Session Inactivity Timeout**, configured in **Group Settings**.

To display a dashboard in kiosk mode with no session timeout, we recommend logging in as a user in the default *guest* group. Alternatively, you can create a kiosk user group with view-only permissions for **Dashboards** and no other view or modify permissions (see [Group Settings on page 61](#)).

To view the dashboard kiosk:

1. View the dashboard as in [Viewing a Dashboard Graph or Table on page 102](#).
2. Click **Kiosk**. The dashboard opens in full screen mode.

NOTE: The graph updates only if the **Period** includes the current day. Otherwise, the dashboard remains static.

Historical Data Export

Historical Data Export allows you to define device topics to download and export a .csv file for each device. The historical data log format and file naming format is the same as a **CSV Export** publication. (See [File Format of CSV Export on page 46](#)).

Available topics only include topics configured for logging (see [Selecting Measurements to Log or Publish on page 82](#)).

Exporting Historical Data

1. Click **Monitoring > Dashboards > Historical Data Export**.
2. Select a device, then select one or more **Available Topics**.
3. Click to move the devices/topics to the queue.
4. Repeat these steps for each device, then click **Download**. A .zip file with the format Com'X Name_Date&time.zip is added to your default download location.

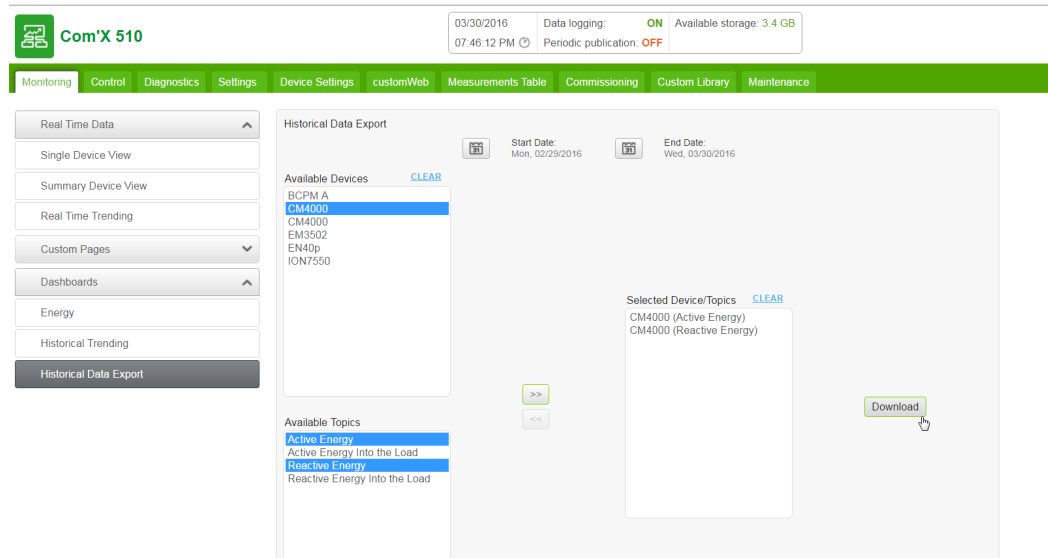

Custom Web Pages

You can view custom pages in **Monitoring > Custom Pages**. To add custom pages to the Com'X 510, see [Custom Page Management on page 69](#).

Control

Device Resets

The Com'X 510 can manually execute one or more predefined reset commands per device type. For a list of parameters available for reset on your device, follow the steps in [Resetting Device Parameters on page 107](#).

Resetting Device Parameters

To reset device parameters:

1. Click **Control > Resets > Device Resets**.
2. Select the devices you want to reset from the **Device Selection** list.
3. Select the reset operation from **Reset Options**.
4. Enter the password for each device requiring a password. The **Reset** button becomes available.

NOTE: The default password check box is populated by the default password provided by the device and is selected by default. You can deselect the default password check box and enter another password.

5. Click **Reset**.

The selected device parameters are reset and the status displays as "ok."

NOTE: Date/Time values are reported only when the device supports them. For example, if a device does not support the Min/Max value for "Date/Time Last Reset," the "Min/Max" value will not be populated here.

Setting Time on Devices

The **Localized Time** is the current date and time on the selected device, adjusted to reflect the time zone selected in the Com'X 510 **Date/Time Settings**.

To reset the time on a device:

1. Click **Control > Set Device Time**.
2. Select the devices you want to reset from the **Device Selection** list.
3. Click **Get Time** to display the **Localized Time** for the device.
4. Click **Set Time** to send the Com'X 510 date/time (UTC) to the device. The status displays as either **Successful** or **Unsuccessful**.

Diagnostics

Diagnostics provides statistical data about the Com'X 510 and connected devices. It also allows you to perform manual register reads and check communications status of connected devices.

Statistics

Statistics shows accumulated readings since the Com'X 510 was last reset.

If power to the Com'X 510 is lost or the device is reset due to a configuration change or other event, all cumulative values reset to zero.

Viewing Statistics

1. Click **Diagnostics > Statistics**.
2. Click one of the following categories: **Network** or **Modbus**.
3. Click the expandable menu for the group of statistics you want to view.
4. Click **Refresh** if you want to update the data.

NOTE: Network statistics update approximately every 10 seconds.

See [Interpreting Statistics on page 109](#) for a list of available parameters.

Resetting Statistics

To reset a category of statistics:

1. Click **Diagnostics > Statistics**.
2. Click one of the following categories: **Network** or **Modbus**.
3. Click **Reset**, then click **Yes** to confirm the reset. Parameters in all expandable menus are reset.

Interpreting Statistics

This section describes the statistics available for the Com'X 510 and connected devices.

- [Modbus Statistics on page 110](#)
- [Network Statistics on page 111](#)

Modbus Statistics

Parameter	Description
RS485	
Messages Received	A counter that increments each time a message is received.
Messages Transmitted	A counter that increments each time a message is sent.
Message Timeouts	A counter that increments each time a request message is sent without receiving a corresponding response message within the allowed time. Timeouts are typically the result of configuration errors or a non-responsive device.
CRC Errors	A counter that increments each time a frame is received that has a checksum/CRC that does not match what is calculated.
Protocol Errors	A counter that increments each time an ill-formed message is received.
Exceptions Received	A counter that increments each time an exception is received.
Device Details	A detailed table providing statistics per device. Click the link to open the table in a new window.
TCP/IP Server	
Messages Received	A counter that increments each time a message is received.
Messages Transmitted	A counter that increments each time a message is sent.
Protocol Errors	A counter that increments each time an ill-formed message is received.
Active Connections	A status value that represents the number of connections (internal and external) that are active at the moment the diagnostics page is refreshed. Click the link to open a dialog box with a list of all of the active external client connections.
Accumulated Connections	A counter that increments each time a connection (internal or external) is made to the Com'X 510.
Maximum Connections	A status value that represents the maximum number of connections that have been made since power up.
TCP/IP Client	
Messages Received	A counter that increments each time a message is received.

Parameter	Description
Messages Transmitted	A counter that increments each time a message is sent.
Message Timeouts	A counter that increments each time a request message is sent without receiving a corresponding response message within the allowed time. Timeouts are typically the result of configuration errors or a non-responsive device.
Connection Timeouts	A counter that increments each time the device times out on a connection request.
Protocol Errors	A counter that increments each time an ill-formed message is received.
Exceptions Received	A counter that increments each time an exception is received.
Device Details	A detailed table providing statistics per device. Click the link to open the table in a new window.

Network Statistics

Parameter	Description
Ethernet	
Speed	A status string that represents the speed setting being used to communicate with the linking partner. Options: <i>10 Mbps</i> or <i>100 Mbps</i>
Duplex	A status string that represents the duplex setting. Options: <i>Full-Duplex</i> or <i>Half-Duplex</i>
Collisions	A counter that increments each time a frame is retransmitted due to collision detection.
CRC Errors	A counter that increments each time a frame is received that has a checksum/CRC that does not match what is calculated.
Frame Errors	A counter that increments each time a receive frame error is detected.
Packets Received OK	A counter that increments each time a packet is successfully received.
Receive Packets Dropped	A counter that increments each time a receive packet is dropped.
Receive Errors	A counter that increments each time a packet is received with a receive error.

Parameter	Description
Packets Transmitted OK	A counter that increments each time a packet is successfully transmitted.
Transmit Packets Dropped	A counter that increments each time a transmit packet is dropped.
Transmit Errors	A counter that increments each time a transmit packet experiences a transmission error.

Read Device Registers

Read Device Registers allows the Com'X 510 to read Modbus registers from its local and remote devices.

Below are **Read Device Registers** settings.

Setting	Description	Options
Device Name	Selects a device to read from the list of previously added devices. A device not defined in the device list can be read by entering its Local ID.	—
Device ID	The address (Local ID) of the device that is to be read.	1-255 Default: 1
Starting Register	The first register to read.	Default: 1000
Number of Registers	The number of registers to read.	1-125 Default: 10
Register	A column displaying the register numbers.	—
Value	A column displaying the data stored for each register. Values retrieved depend on the device connected to the Com'X 510. Refer to the documentation for the connected device for more information about stored register values.	—
Data Type	Menu for selecting the type of data the registers hold and the format (Decimal, Hexadecimal, Binary, or ASCII) you want returned.	Holding Registers, Input Registers, Output Coils, Input Coils, or Device ID Default: Holding Registers.

Reading Device Registers

To read device registers:

1. Click **Diagnostics > Read Device Registers**.
2. Select a device from the **Device Name** drop-down list, or choose **Select by Device ID** for devices that aren't in the device list.
3. If you chose **Select by Device ID**, enter the **Local ID**. If you selected a device name in the previous step, this field is populated automatically and cannot be changed.

NOTE: The **Slave ID** is the identifier on the serial port to which it is connected. The **Local ID** is the identifier used by the Com'X 510.

4. Enter a starting register and the number of registers to read.
5. Select a data type.
6. If you selected **Holding** or **Input registers**, choose a format for the returned data.
7. Click **Read**.

Communications Check

The communication status of a device is evaluated with each communication initiated by the Com'X 510, for example when using Real Time Data.

When the **Out of Service Time** is enabled, the Com'X 510 discontinues communications to a device after two consecutive message time-outs. The Com'X 510 treats the device as out of service and does not attempt to communicate with it again until the **Out of Service Time** period has expired.

This reduces unnecessary network traffic by removing messages going to a device that is known to be out of service. You can circumvent the timer by manually initiating a communications check.

If you do not enable **Out of Service Time**, the Com'X 510 continues to attempt communications with the device, and time-outs from unresponsive devices will affect bandwidth of external clients.

In the **Communications Check** subtab, you can [execute a manual communications check](#) as well as [configure the Out of Service timer](#) for re-establishing communication.

Executing a Manual Communications Check

In certain cases, you may not want to wait for the automated communications check interval and need to force the check to run manually. To perform a manual communications check:

1. Click **Diagnostics > Communications Check**.
2. Click **Check Device Status** to begin the check.

3. Optionally, you can click **Stop Status Check** to stop the check.

The Status column displays **In Service** or **Out of Service**.

Defining the Out of Service Time

To define the **Out of Service Time**:

1. Click **Diagnostics > Communications Check**.
2. Select **Yes** for **Enable Out of Service Time**.
3. Select the **Out of Service Time**. Options are 1, 2, 3, 4, 5, 10, 15, 30 and 60 minutes (default: 15).
4. Click **Save changes**.

Custom Library

Custom Models

The Com'X 510 supports the use of custom models. A custom model is any model other than a Built-in model from Schneider Electric. To use a custom model, you must first create a new custom model. A custom model can be:

- based on a pre-existing Schneider Electric model
- based on a previously created custom model
- an entirely new model

If you base a custom model on a pre-existing Schneider Electric model or a previously created custom model, the new model inherits the properties of the underlying model on which it is based. Inheritance simplifies the task of creating a new custom model, because you need only add or edit properties unique to the new custom model in order to create it.

Creating a Custom Model

To create a new custom model:

1. Click the **Custom Library** main tab.
2. Click **+Create** on the lower left part of the page. The **Create a custom model** dialog opens.
3. Define the new model by entering the following settings:

Field	Setting
Select model type	Select a model type from the list. This selection determines the properties structure of the new custom model.
Create model	Select the basis for the new custom model: <ul style="list-style-type: none"> • New • Based on a Schneider model • Based on a custom model
<base model type>	If the new custom model is based on an existing Schneider model or a custom model, select the existing model on which the new model is based.
Model name	Enter the name of the new custom model, or accept the default name

Default value of commodity	Select a default commodity the new model measures.
Default value of usage	Select a default value for how the new model is used.

4. Click **Create**. The dialog closes, and the newly created custom model properties page opens for initial configuration.

Refer to the following topics for a description of custom model properties configurations.

Custom Modbus Devices

The Com'X 510 can also communicate with any third-party Modbus device. This type of Modbus device is called Modbus serial line custom slave.

The Com'X 510 is able to communicate with a Modbus serial line custom slave in two ways:

- directly by using its own serial port
- through a ModbusTCP/Modbus serial line gateway

Creating a Modbus Custom Slave

To create a new custom Modbus custom slave model:

1. Click the **Custom Library** main tab.
2. Click **+Create** on the lower left part of the page. The **Create a custom model** dialog opens.
3. Enter the following settings:

Field	Setting
Select model type	Select Modbus RTU or Modbus TCP.
Create model	Select the basis for the new custom model: <ul style="list-style-type: none"> • New • Based on a Schneider Electric model • Based on a custom model
<base model type>	If you are basing the new custom model on an existing Schneider Electric model or a custom model, select the existing model on which the new model is based.
Model name	Enter the name of the new custom model, or accept the default name <code>Modbus RTU Slave_Custom</code> or <code>Modbus TCP Slave_Custom</code> .

Default value of commodity	Select a default commodity the new model measures.
Default value of usage	Select a default value for how the new model is used

- Click **Create**. The dialog closes, and the newly created custom model properties page opens for initial configuration.

Defining a Modbus Custom Slave

After you have created the new Modbus custom slave model, you can complete its definition in the **Custom Library**.

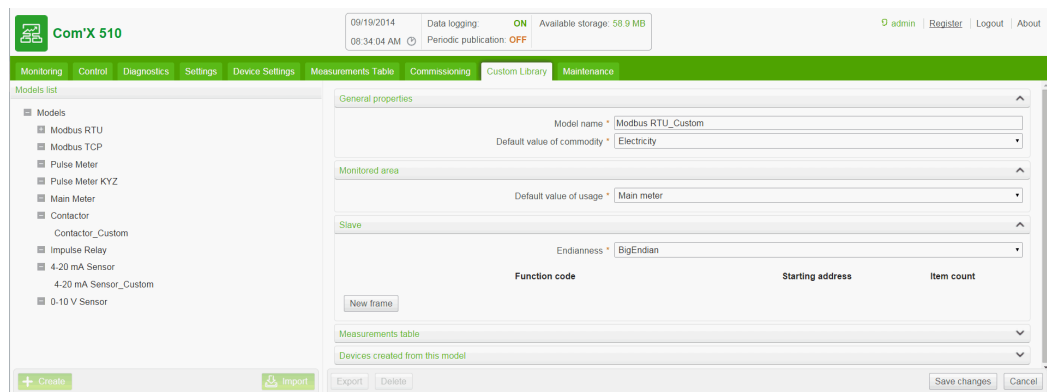

Follow this procedure to add a Modbus generic slave to the custom model created above:

- Select the new model in the model tree view, then click the **Slave** collapsible menu.
- Select the reading order in the **Endianness** drop-down list. This setting describes the register order to be used when a variable is formatted with more than one register.

NOTE: The endianness depends on the device and must be selected in the Com'X 510 settings. For example, PM700 is big endian and PM800 is little endian. The endianness setting is not used if variables are formatted with 16-bit registers.

- Click **New frame**.

Continue to [Creating a Modbus Frame on page 118](#) to define a new frame.

Modbus Custom Slave Register Examples

Register	Register Number	Read/write	Scale	Unit	Format	Interval	Description
1037	1	R	x1	kW	INT	+/- 0...32767	Total active power
1041	1	R	x1	kVAR	INT	+/- 0...32767	Total reactive power
1049	1	R	x1000	None	INT	- 1000...1000	Total power factor
1054	1	R	x10	Hz	INT	0...4000	System frequency

When reading the device documentation, it appears that all variables can be read with 1 frame of registers (Function code 03) starting from register 1037 and ending with register 1054 (count = 18).

Creating a Modbus Frame

In the Modbus protocol, the data exchange is described by frames. A frame is a request to read an array of consecutive variables. Several frames can be necessary to access all the variables of a device. To enhance performance, reduce the number of frames by mapping several variables to the same frame.

When you click **New** frame, a new line with default settings appears:

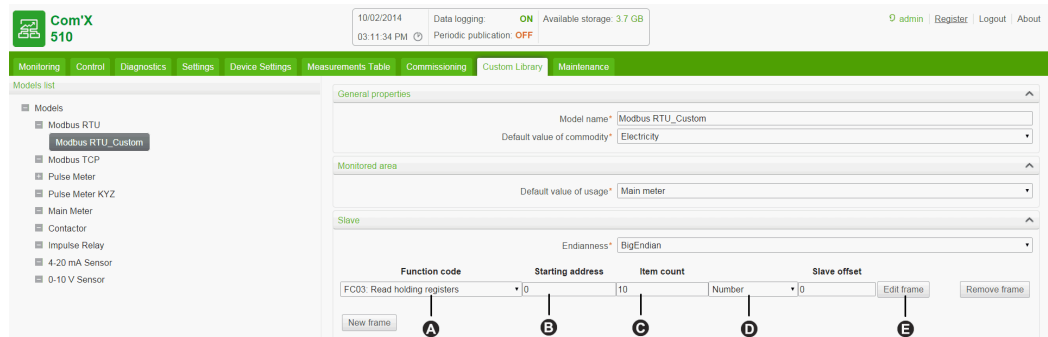

Item	Name	Description	Options
A	Function code	Specifies the types of read requests that the Com'X 510 can perform.	<ul style="list-style-type: none"> FC01: coils (array of output or internal bits) FC02: discrete input (array of input bit) FC03: holding registers (array of output or 16-bit internal registers) FC04: input registers (array of 16-bit input registers)
B	Starting address	Specifies the address.	0–65535 ⁽¹⁾
C	Item count	Specifies the number of items that the frame contains.	<ul style="list-style-type: none"> 1–1000 for function code FC01 or FC02 1–125 for function code FC03 or FC04
D	Number	Specifies the type of information that is mapped on this frame.	<ul style="list-style-type: none"> Boolean for FC01 or FC02 function code Boolean or number for FC03 or FC04 function code
E	Edit frame	Describes the variables of this frame.	–

(1)There is an offset between register number and address. Register numbers can be found in the device documentation.

When you finish adding and configuring frame settings, click **Save changes**.

Creating Modbus Variables

Click **Edit frame**. A dialog box appears and allows you to set up each variable.

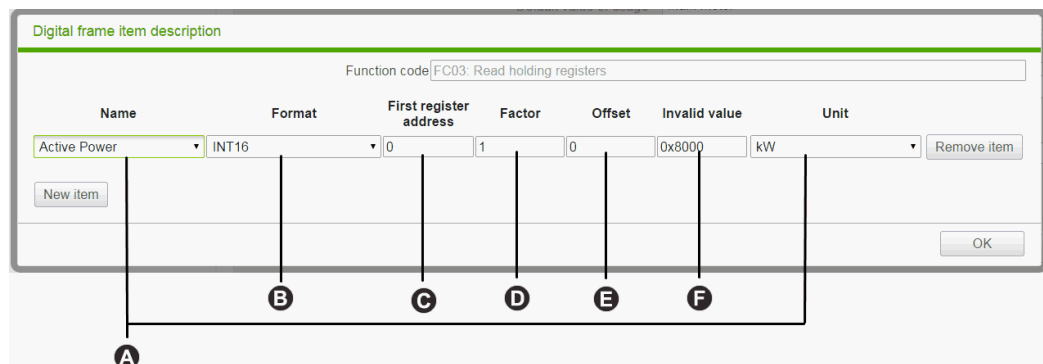

Click **New item** to create a new variable, and fill in these different fields:

Item	Field	Description	Comment
A	Name and Unit	Enables you to select a variable name from the Name list. This variable name determines the Unit options.	You can select Customized in the drop-down list and type a new text string for the name field and the unit field.
B	Format	Specifies the format of this number.	Several formats are available as described in the table below.
C	First register address	Specifies the first register number.	The register number must belong to the range of the frame. If the format contains more than 1 register, the setting checks that the last register used by this measurement is inside the frame content.
D	Factor	The displayed measure = (transmitted value x factor) + offset.	The displayed measure is the value displayed in the measurement tables. Transmitted value is the measure done by the meter.
E	Offset		
F	Invalid value	Indicates the transmitted value is invalid.	–

When you finish adding and configuring frame settings, click **OK** to close the dialog, then click **Save changes**.

The table describes the available formats:

Format	Description	Minimum Value	Maximum Value	Use "Endian" Setting
INT16	1 register with signed integer value	–32768	32767	No
UINT16	1 register with positive integer value	0	65535	No
INT32	2 registers with signed integer value	–2147483648	2147483647	Yes
UINT32	2 registers with positive integer value	0	4294967295	Yes

Format	Description	Minimum Value	Maximum Value	Use "Endian" Setting
FLOAT32	2 registers with signed floating point value coded according to IEEE754 standard	-1E-10	+1E-10	Yes
UINT32_MOD10K	2 registers with positive integer value from 0 to 9999	0	99999999	Yes
INT64	4 registers with signed integer value	-2 (^63)	-2 (^63)-1	Yes
UINT64	4 registers with positive integer value	0	-2 (^63)-1	Yes
UINT64_MOD10K	4 registers with positive integer value from 0 to 9999	0	9 999 999 999 999 999	Yes

Modbus Variable Creation Example

This graphic shows an example of settings:

Digital frame item description

Function code: FC03: Read holding registers

Name	Format	First register address	Factor	Offset	Invalid value	Unit	
Active Power	INT16	0	1	0	0x8000	kW	Remove item
Reactive Power	INT16	0	1	0	0x8000	kVAr	Remove item
Apparent Power	INT16	0	1	0	0x8000	VA	Remove item
Frequency	INT16	0	1	0	0x8000	kHz	Remove item

New item

OK

Adding a Custom Modbus Device

After you create a custom Modbus device in the Custom Library, you can add it to your network in the same way you add any Modbus device: either by [Discovering Connected Devices on page 85](#), or by [Adding a Modbus Device Manually on page 87](#).

Custom Pulse Meter Model

You can create a customized pulse meter by inputting customized settings for the following measure properties:

- Count element
- Count unit
- Flow element
- Flow unit

Creating a Custom Pulse Meter

To create a new custom generic pulse meter model, follow these steps:

1. Click the **Custom Library** main tab.
2. Click **+Create** on the lower left part of the page. The **Create a custom model** dialog opens.
3. Enter the following settings:

Field	Setting
Select model type	Select Pulse Meter .
Create model	Select the basis for the new custom model: <ul style="list-style-type: none"> • New • Based on a Schneider Electric model • Based on a custom model
<base model type>	If you are basing the new custom model on an existing Schneider Electric model or a custom model, select the existing model on which the new model is based.
Model name	Enter the name of the new custom model, or accept the default name <code>Pulse Meter_Custom</code> .
Default value of commodity	Select a default commodity the new model measures.
Default value of usage	Select a default value for how the new model is used

4. Click **Create**. The dialog closes, and the newly created custom model properties page opens for initial configuration.

Measure Properties

This graphic shows the measure properties for a newly created custom pulse meter model:

The screenshot shows the Com'X 510 web interface. At the top, there is a header with the logo, date (10/02/2014), time (03:06:10 PM), and system status (Data logging: ON, Available storage: 3.7 GB, Periodic publication: OFF). Below the header is a navigation menu with tabs: Monitoring, Control, Diagnostics, Settings, Device Settings, Measurements Table, Commissioning, Custom Library, and Maintenance. The 'Custom Library' tab is selected. On the left, a 'Models list' sidebar shows a tree view with 'Pulse Meter' expanded and 'Pulse Meter_Custom' selected. The main content area displays the 'Measure Properties' configuration form. The form has several sections: 'General properties', 'Monitored area', 'Measure Properties', 'Measurements table', and 'Devices created from this model'. The 'Measure Properties' section contains the following fields:

- Count element*: Active Energy
- Count unit*: kWh
- Pulse weight*: 1
- Upper range*: 1000000000
- Flow element*: Active Power
- Flow unit*: kW

The measure properties include the following:

Field	Description
Count element	Select a measure element from the list, or select Custom and type a personalized name into the Custom count element field.
Count unit	Select a measure unit from the list, or select Custom and type a personalized unit into the Custom count unit field.
Pulse weight	The pulse counter increases by this value each time a pulse is received. The list is restricted to the values that correspond to the selected meter type.
Upper Range	Defines when the active energy counter rolls back to zero.
Flow element	Select a flow element from the list, or select Custom and type a personalized name into the Custom flow element field.
Flow unit	Select a flow unit from the list, or select Custom and type a personalized unit into the Custom flow unit field.

Measurements Table

The measure property selections you make, including customized properties, are reflected in the measurements table. The following example displays customized count and flow elements and units:

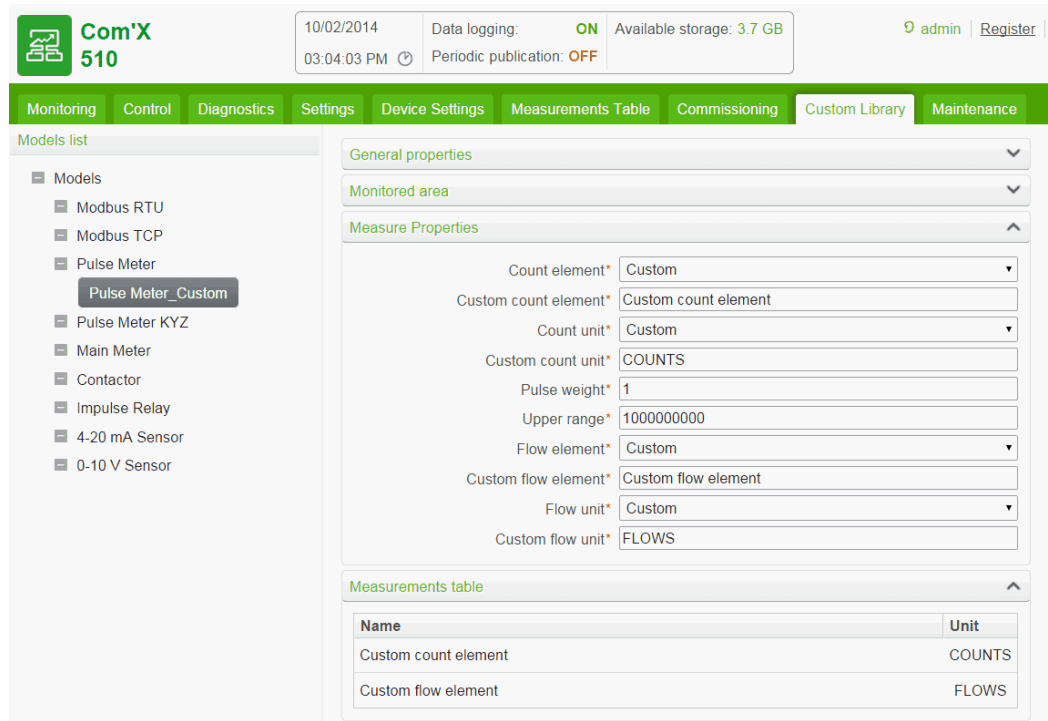

Custom KYZ Pulse Meter Model

The custom KYZ pulse meter model has a dry contact closure that changes state each time the counter advances.

The Com'X 510 detects the change of state, and the counter increases by the pulse weight value.

NOTE: Each instance of a custom KYZ pulse meter needs to be directly connected to the digital inputs of the Com'X 510.

Measurement Properties

The custom KYZ pulse meter model presents the same Measure Properties and Measurements table items as in [Creating a Custom Pulse Meter on page 122](#).

Index Counter

This graphic shows the difference between a KYZ pulse meter and a standard pulse meter (pulse weight = 10):

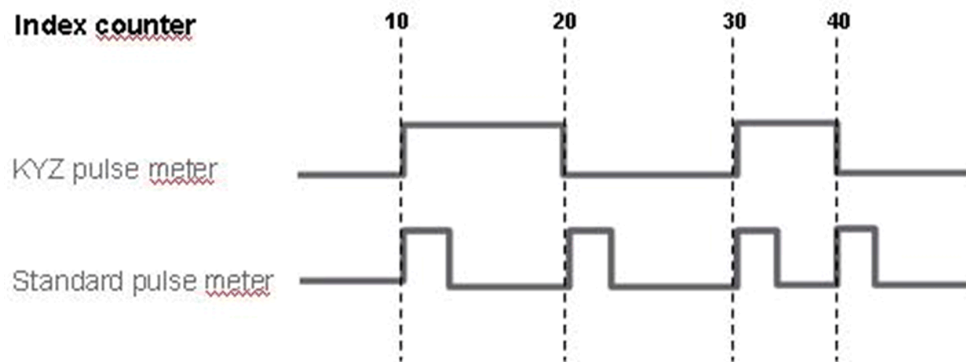

Custom Main Meter Model

The custom main meter model is made up of two pulse outputs and four contact outputs. You can create a customized main meter by entering customized settings for the following measure properties of each of the two pulse outputs:

- Count element
- Count unit
- Flow element
- Flow unit

The signal properties of the four contact outputs present the same configuration choices as the Schneider Electric standard main meter.

Creating a Custom Main Meter

To create a new custom main meter model, follow these steps:

1. Click the **Custom Library** main tab.
2. Click **+Create** on the lower left part of the page. The **Create a custom model** dialog opens.
3. Enter the following settings:

Field	Setting
Select model type	Select Main Meter .

Create model	<p>Select the basis for the new custom model:</p> <ul style="list-style-type: none"> • New • Based on a Schneider Electric model • Based on a custom model
<base model type>	<p>If you are basing the new custom model on an existing Schneider Electric model or a custom model, select the existing model on which the new model is based.</p>
Model name	<p>Enter the name of the new custom model, or accept the default name <code>Main Meter_Custom</code>.</p>
Default value of commodity	<p>Select a default commodity the new model measures.</p>
Default value of usage	<p>Select a default value for how the new model is used</p>

4. Click **Create**. The dialog closes, and the newly created custom model properties page opens for initial configuration.

Main Meter Measure and Signal Properties

This graphic shows the measure and signal properties for a newly created custom main meter model:

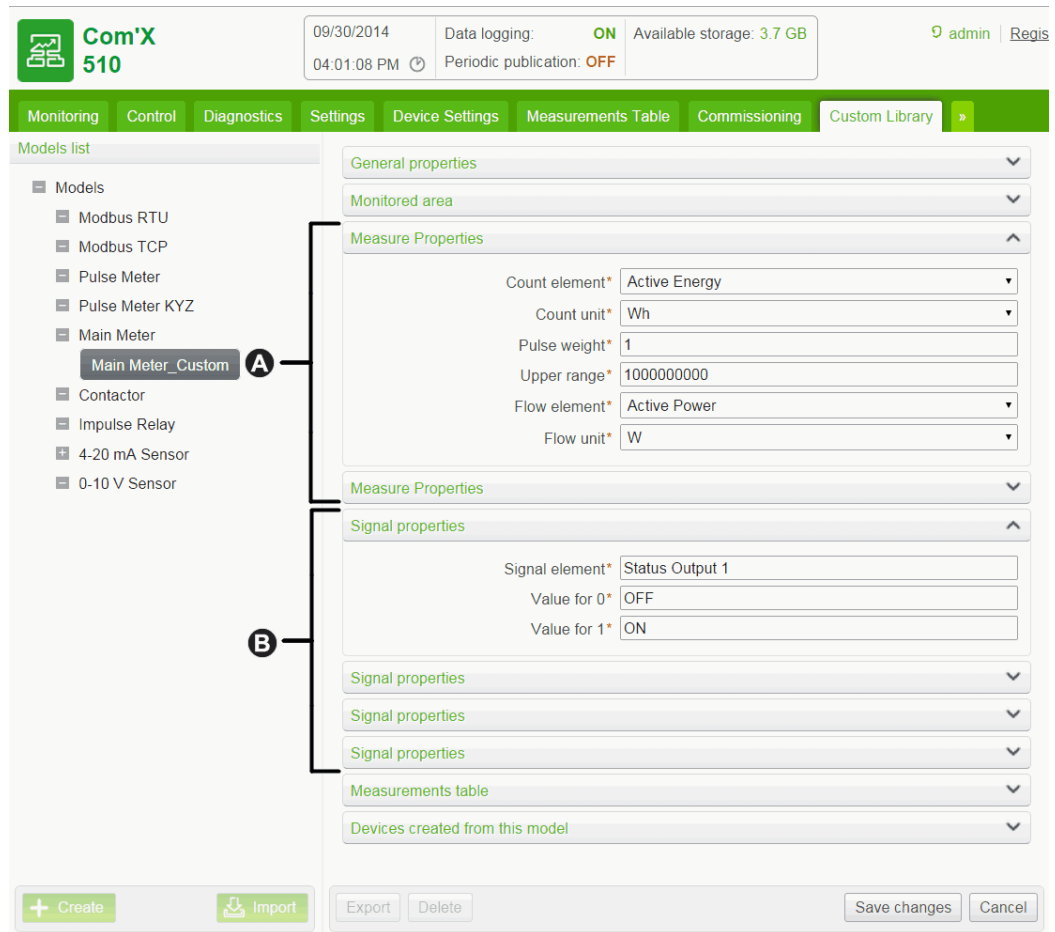

A	Two pulse outputs
B	Four contact outputs

Each pulse output presents the following measure properties:

Field	Description
Count element	Select a measure element from the list, or select Custom and enter a personalized name into the Custom count element field.
Count unit	Select a measure unit from the list, or select Custom and enter a personalized unit into the Custom count unit field.
Pulse weight	The pulse counter increases by this value each time a pulse is received. The list is restricted to the values that correspond to the selected meter type.
Upper Range	Defines when the active energy counter rolls back to zero.
Flow Element	Select a flow element from the list, or select Custom and enter a personalized name into the Custom flow element field.

Field	Description
Flow unit	Select a flow unit from the list, or select Custom and enter a personalized unit into the Custom flow unit field.

Each contact output presents the following signal properties:

Field	Description
Signal element	Enter the name of this signal, or accept the default name Status Output n , where n represents the signal number (1 to 4).
Value for 0	Enter the status associated with a value of 0. Default is OFF .
Value for 1	Enter the status associated with a value of 1. Default is ON .

Measurements Table

The measure and signal property selections you make, including customized properties for pulse outputs, are reflected in the measurements table. The following example displays customized count and flow elements and units for the second measure property:

The screenshot shows the 'Measure Properties' configuration page in the Com'X 510 interface. The page has a top navigation bar with tabs for Monitoring, Control, Diagnostics, Settings, Device Settings, Measurements Table, Commissioning, Custom Library, and Maintenance. The 'Measure Properties' section contains several fields: 'Count element*' (Custom), 'Custom count element*' (Custom count element 2), 'Count unit*' (Custom), 'Custom count unit*' (Custom count unit 2), 'Pulse weight*' (1), 'Upper range*' (1000000000), 'Flow element*' (Custom), 'Custom flow element*' (Custom flow element 2), 'Flow unit*' (Custom), and 'Custom flow unit*' (Flow unit 2). Below this is a 'Measurements table' with the following data:

Name	Unit
Custom count element 2	Custom count unit 2
Custom flow element 2	Flow unit 2
Reactive Energy	VArh
Reactive Power	VAr
Status Output 1	OFF / ON
Status Output 2	OFF / ON
Status Output 3	OFF / ON

Adding a Custom Main Meter

After you create a custom main meter model in the **Custom Library**, you can add instances of that custom main meter in the **Device Settings**.

When you add a custom main meter, the two pulse outputs are automatically connected to the upstream device. You can connect the four contact outputs as in [Connecting a Standard Main Meter on page 129](#).

Connecting a Standard Main Meter

There are two ways of connecting the contact outputs.

The first way is from the properties collapsible menu of the standard main meter:

1. Click the **Device Settings** main tab.
2. Select the main meter in the device tree view.
3. Select **Pulse Output 1** in the **Properties** collapsible menu.

Contact Status	Connected to	Connector
Contact Status 1	ComX200_JEF_OK	I4
Contact Status 2	No device connected	None
Contact Status 3	No device connected	None
Contact Status 4	No device connected	None

4. Select the number of digital outputs in the drop-down list.
5. Repeat steps 3 and 4 for the **Pulse Output 2** properties.
6. Click **Save changes**.

The second way is from the properties area of the upstream device:

1. Click the **Device Settings** main tab.
2. Select the upstream device in the device tree view.
3. Click the **Digital and analog inputs** collapsible menu.
4. Select the name of the main meter in the **Device** drop-down list.
5. Select the contact output that has to be connected in the **Connector** drop-down list.

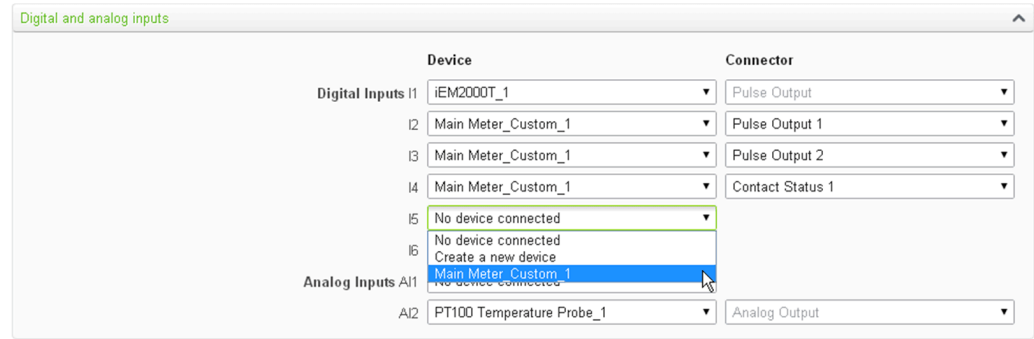

6. Click **Save changes**.

The device tree view shows that the standard main meter is connected to an additional digital input.

Custom Contactor or Impulse Relay

Connecting a contactor or impulse relay to a digital input allows you to monitor status output. The counter runs when the contact is closed.

Creating a Custom Contactor or Impulse Relay

To create a new custom generic pulse meter model, follow these steps:

1. Click the **Custom Library** main tab.
2. Click **+Create** on the lower left part of the page. The **Create a custom model** dialog opens.
3. Enter the following settings:

Field	Setting
Select model type	Select either Contactor or Impulse Relay .
Create model	Select the basis for the new custom model: <ul style="list-style-type: none"> • New • Based on a custom model
<base model type>	If you are basing the new custom model on an existing custom model, select the existing model on which the new model is based.
Model name	Enter the name of the new custom model, or accept the default name <code>Contactor Custom</code> or <code>Impulse Relay Custom</code> .
Default value of commodity	Select a default commodity the new model measures.

Field	Setting
Default value of usage	Select a default value for how the new model is used

- Click **Create**. The dialog closes, and the newly created custom model properties page opens for initial configuration.

Measurement Properties

This table shows the measurement properties of a contactor or impulse relay:

Field	Description
Signal element	Enter the element being monitored, or accept the default Status Output.
Value for 0	Enter the state represented by a value of 0, or accept the default OFF.
Value for 1	Enter the state represented by a value of 1, or accept the default ON.

Measurement Table

This graphic shows the measurement table interface:

The screenshot displays the Com'X 510 web interface. At the top, there's a header with the date '09/10/2014', time '03:42:07 PM', and system status like 'Data logging: ON' and 'Available storage: 58.1 MB'. A navigation bar includes 'Monitoring', 'Control', 'Diagnostics', 'Settings', 'Device Settings', 'Measurements Table' (highlighted), 'Commissioning', 'Custom Library', and 'Maintenance'. On the left, a 'Models list' shows various device types, with 'Contactor' expanded to show 'Contactor_Custom'. The main area is titled 'Measurements table' and contains several sections: 'General properties', 'Monitored area', 'Signal properties' (with fields for 'Signal element', 'Value for 0', and 'Value for 1'), and a table for 'Measurements table' with columns 'Name' and 'Unit'. The table lists 'Status Output' with unit 'OFF / ON'. At the bottom, there are buttons for '+ Create', 'Import', 'Export', 'Delete', 'Save changes', and 'Cancel'.

By default, measurements are logged and published to the hosted platform.

Creating a Custom Analog Sensor Model

The Com'X 510 offers two analog sensor templates:

- 4...20 mA
- 0...10 V

Each custom analog sensor model monitors a single point. You can create a customized analog sensor model by entering customized settings for the following properties:

- Count element
- Count unit

Creating a Custom Analog Sensor

To create a new custom analog sensor model, follow these steps:

1. Click the **Custom Library** main tab.
2. Click **+Create** on the lower left part of the page. The **Create a custom model** dialog opens.
3. Enter the following settings:

Field	Setting
Select model type	Select either 4-20 mA Sensor or 0-10 V Sensor .
Create model	Select the basis for the new custom model: <ul style="list-style-type: none"> • New
Type	Enter the name of the new custom model, or accept the default name, either <code>Sensor 4-20mA_Custom</code> or <code>Sensor 0-10V_Custom</code> , depending on the selected model type.
Default value of commodity	Select a default commodity the new model measures.
Default value of usage	Select a default value for how the new model is used

4. Click **Create**. The dialog closes, and the newly created custom model properties page opens for initial configuration.

Measure and Signal Properties

This graphic shows the monitored area properties for a new custom 4...20 mA analog sensor model:

Each pulse output presents the following measure properties:

Field	Description
Element	Select a monitoring element from the list, or select Custom and enter a personalized name into the Custom element field.
Unit	Select a monitoring unit from the list, or select Custom and enter a personalized unit into the Custom unit field.
LowerBound	The value mapped as the minimum monitored value.
UpperBound	The value mapped as the maximum monitored value.

Measurements Table

The monitoring property selections you make, including customized properties, are reflected in the measurements table. The following example displays a customized count elements and unit:

The screenshot displays the 'Custom Library' interface for the Com'X 510 Energy Server. The top navigation bar includes tabs for Monitoring, Control, Diagnostics, Settings, Device Settings, Measurements Table, Commissioning, Custom Library, and Maintenance. The 'Custom Library' tab is selected, showing a 'Models list' on the left and a configuration form on the right. The configuration form is divided into several sections: 'General properties', 'Monitored area', 'Sensor properties', and 'Measurements table'. The 'Sensor properties' section is expanded, revealing fields for 'Element' (set to 'Custom'), 'Custom element' (set to 'Custom element name'), 'Unit' (set to 'Custom'), 'Custom unit' (set to 'Custom unit'), 'LowerBound' (set to '-10'), and 'UpperBound' (set to '40'). The 'Measurements table' section shows a table with two columns: 'Name' and 'Unit'. A single row is present with 'Custom element name' in the 'Name' column and 'Custom unit' in the 'Unit' column. At the bottom of the interface, there are buttons for '+ Create', 'Import', 'Export', 'Delete', 'Save changes', and 'Cancel'.

Working with Custom Models

This section describes the following:

- [Modifying a Custom Model](#) on page 134
- [Deleting a Custom Model](#) on page 135
- [Exporting One or More Custom Models](#) on page 135
- [Importing One or More Custom Models](#) on page 135

Modifying a Custom Model

To modify the settings of an existing custom model:

1. Click the **Custom Library** main tab.
2. Display a list of existing models. Either:
 - Click **Models** in the navigation tree to display a list of all models, or
 - Click **Models**, then **<Model Type>** (for the model type you wish to modify) to display a list of models of the selected type.
3. Click the model in the list you want to modify.
4. Make your edits of the configurable properties for the selected model.
5. Click **Save changes**.

Deleting a Custom Model

You can only delete a model if no devices have been created from the model. To delete an existing custom model:

1. Click the **Custom Library** main tab.
2. Display a list of existing models. Either:
 - Click **Models** in the navigation tree to display a list of all models, or
 - Click **Models**, then **<Model Type>** (for the model type you wish to delete) to display a list of models of the selected type.
3. Do one of the following. Either:
 - To delete a single model, click the delete icon () in the row for the model you want to delete, or
 - To delete multiple models, place a check mark next to the models you want to delete, then click **Delete**.

NOTE: A model is deleted when you issue the delete command. No message box appears and asks you to confirm the delete command.

Exporting One or More Custom Models

To export one or more custom models:

1. Click the **Custom Library** main tab.
2. Navigate to the model you want to export. Either:
 - Click **Models** in the navigation tree to display a list of all models, or
 - Click **Models**, then **<Model Type>** (for the model type you wish to export).
3. Do one of the following. Either:
 - To export a single model, click the **Export** icon () in the row for the model you want to export, or
 - To export multiple models, place a check mark next to the models you want to export, then click **Export**.

The exported model is wrapped in a .zip file and sent to the default download location of your browser.

Importing One or More Custom Models

To import one or more custom models:

1. Click the **Custom Library** main tab.
2. Click **Import**. The Import models dialog opens.

3. Click **Browse**. The **Open** dialog appears.
4. In the **Open** dialog, navigate to and select the custom model or models to import, then click **Open**.
5. In the **Import models** dialog, click **Import**.
6. After the import process is complete, click **Close**. The imported model or models appear in the **Custom Library** beneath the appropriate device type.

Maintenance

Logs

The **Logs** subtab displays the list of events that have been logged with the recorded date and time and a short description of the event.

The Com'X 510 displays logs for at least 10 minutes before power outage or shutdown.

Schneider Electric recommends checking the logs periodically for excessive denied accesses, unexpected firmware upgrades or unplanned backup restoration. These can be signs of fraudulent attacks. If this happens, contact your local Schneider Electric technical support.

This graphic shows the interface of the logs:

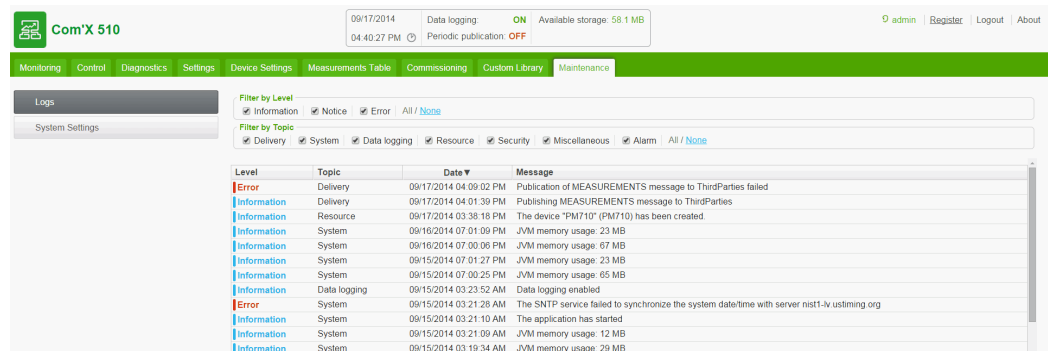

Downloading Com'X 510 Logs

Get diagnostics info allows you to download the Com'X 510 logs.

The downloaded file cannot be read with common software. This file is useful only to Schneider Electric technical support.

Logged Events

The events that are logged are:

Topic	Event
Resource	Change in the configuration of: <ul style="list-style-type: none"> • devices • publication
Delivery	Publication steps and status (unsuccessful or successful)
	Activation/deactivation of the periodic publication

Topic	Event
Logging	Activation/deactivation of the data logging
Security	Unsuccessful login
Alarm	Low level of GPRS/3G signal
	Error detected during the login
	Device not communicating
	CPU and RAM overuse
	SD card full or SD card reaches 80% of its capacity
	Communication interruptions with metering devices
	Insert or remove SD card
System	Time setting modification
	Firmware update and status
	Boot time

System Settings

System Settings allows you to [save](#) and [restore](#) a configuration, [upgrade Com'X 510 firmware](#), and [enable remote access](#) for support.

Save the Configuration

The whole configuration of the Com'X 510 can be saved to a file to be restored on the same Com'X 510. You should save a backup configuration before and after each firmware upgrade (see [Upgrade Firmware on page 143](#)).

Backup files contain sensitive information (such as network passwords).

NOTICE

HAZARD OF UNAUTHORIZED ACCESS

Do not communicate a backup file to unauthorized persons.

Failure to follow these instructions can result in equipment damage.

The file name is in the format `Com'X 510 name_Firmware version_YYYYMMDD-HHMM.zip`. For example, `MyCom'X 510_V1.0_20130110_1020.zip` indicates that the file is generated from:

- a Com'X 510 named `MyCom'X 510`
- running on the firmware version 1.0

- on January 10th 2013 at 10:20 a.m.

The configuration can be saved only after the initial configuration or updating is completed.

NOTE: This feature is not available on the iPad.

Saving the Configuration Locally

To save the configuration locally:

1. Click **Maintenance > System Settings**.
2. Click **Save Configuration** in the **Configuration Management** collapsible menu. According to the web browser used, a dialog box appears to open, save, or cancel the configuration file.
3. Select the option to save the file in the dialog box. The date and time of the last configuration backup are displayed under the **Save Configuration** button.
4. In the **Choose File** field, select the location on the computer to save the file and save the configuration.

Saving the Configuration for Duplication on Another Com'X 510

When you back up an existing configuration file for duplication on another device, the backup file contains the original configuration, except for the following settings:

- The device **Name** field is set to Com'X 510_xxyyzz, where xxyyzz represents the last three hexadecimal octets of the device MAC address
- the **Site name** field is left blank (a new Energy Operation site ID is created)

NOTE: Do not use this procedure with a backup from a box connected to DSP.

To duplicate the configuration so that it can be applied to a different Com'X 510:

1. Click the **Maintenance > System Settings**.
2. Click **Backup for duplication** in the **Configuration Management** collapsible menu. The duplication file is stored on the local PC at the default location for internet browser downloads.

Saving the Configuration via the USB Port

⚠ DANGER

HAZARD OF ELECTRIC SHOCK, EXPLOSION, OR ARC FLASH

- This equipment must only be installed and serviced by qualified personnel.
- Apply appropriate personal protective equipment (PPE) and follow safe electrical work practices. See NFPA 70E in the USA, CSA Z462 or applicable local standards.

Failure to follow these instructions will result in death or serious injury.

To save the configuration to a USB key:

1. Insert a USB key into the USB port on the Com'X 510 front panel.

2. Press and hold the **Backup** button  for at least three seconds. During backup the USB LED behaves as follows:
 - If no error is detected during backup, the USB LED blinks green for 500 ms, then off for 500 ms.
 - If an error is detected, the USB LED blinks green for 250 ms, then off for 250 ms for a total of three seconds.
3. If no error is detected during backup, the backup is complete when the blinking stops. You can remove the USB key from the Com'X 510 front panel.

Restore the Configuration

You can restore configuration in the following ways:

- [Restoring the Configuration with a Local File on page 140](#)
- [Restoring the Configuration with a USB Key on page 141](#)

Restoring the Configuration with a Local File

When restoring the configuration with a local file (see [Save the Configuration on page 138](#)), the current password is unchanged.

NOTE: Do not restore a backup made without a connection to Digital Service Platform to a box after a connection to DSP has been made.

Follow this procedure to restore the configuration on the same Com'X 510:

1. Click the **Maintenance > System Settings**.
2. Click the **Configuration Management** collapsible menu.

3. In the **File** field, select the file that has to be uploaded to restore the configuration.
4. Click **Open** for the selected file to appear.
5. Click **Apply the configuration**.
6. Wait for the Com'X 510 to reboot. The power LED turns green when the reboot is complete.
7. Log in to the Com'X 510.
8. Check the configuration in the settings tabs and start the publication again from the **Commissioning** tab.

Restoring the Configuration with a USB Key

⚠ DANGER

HAZARD OF ELECTRIC SHOCK, EXPLOSION, OR ARC FLASH

- This equipment must only be installed and serviced by qualified personnel.
- Apply appropriate personal protective equipment (PPE) and follow safe electrical work practices. See NFPA 70E in the USA, CSA Z462 or applicable local standards.

Failure to follow these instructions will result in death or serious injury.

Follow this procedure to restore a locally saved configuration file (see [Save the Configuration on page 138](#)) on the same Com'X 510 using a USB key:

1. Copy the saved configuration file to a folder named "Restore" at the root of the USB key.
2. Power off Com'X 510, then plug the USB key into the USB port on the Com'X 510 front panel.
3. Power on the Com'X 510 and wait for it to reboot. When the power LED turns green, the reboot is complete.
4. Log in to the Com'X 510.
5. Check the configuration in the settings tabs and start the publication again from the **Commissioning** tab.

Upload a Duplicate Configuration File from Another Com'X 510

You can upload a duplicate configuration file in the following ways:

- [Uploading a Duplicate Configuration with a Local File on page 142](#)
- [Uploading a Duplicate Configuration with a USB Key on page 142](#)

Uploading the configuration file from another Com'X 510 is not possible remotely through DSP.

Uploading a Duplicate Configuration with a Local File

After [Saving the Configuration for Duplication on Another Com'X 510 on page 139](#), follow this procedure to upload a duplicate configuration file from another Com'X 510:

1. Click the **Maintenance** main tab.
2. Click the **System Settings** subtab.
3. Click **Browse** in the **Configuration Management** collapsible menu.
4. Select the locally saved configuration file.
5. Click **Open** for the selected file to appear.
6. Click **Apply the configuration**.
7. Wait for the Com'X 510 to reboot. The power LED turns green when the reboot is complete.
8. Reconnect to the Com'X 510.
9. Click **Settings > Site Settings > Site Information**.
10. Type the new site location name, then click **Save changes** to save the modification.

NOTE: The site location name may not include any of the following: '/*?<>| or space.

11. Click the **Device Settings** tab.
12. Select the Com'X 510 in the Device tree view.
13. Type the Com'X 510 name in the **General Properties** collapsible menu.
14. Click **Save changes** to save your modification.
15. Click the **Measurement table** tab to check the correct connection, setting, and functioning on the new site.
16. Select **Commissioning** tab to activate logging and publication according to destination platform (see [Commissioning on page 95](#) for more information)

Uploading a Duplicate Configuration with a USB Key

 DANGER
<p>HAZARD OF ELECTRIC SHOCK, EXPLOSION, OR ARC FLASH</p> <ul style="list-style-type: none">• This equipment must only be installed and serviced by qualified personnel.• Apply appropriate personal protective equipment (PPE) and follow safe electrical work practices. See NFPA 70E in the USA, CSA Z462 or applicable local standards. <p>Failure to follow these instructions will result in death or serious injury.</p>

To upload a duplicate configuration file from another Com'X 510 using a USB key:

1. Copy the duplicate configuration file to a folder named "Restore" at the root of the USB key.

2. Power off the Com'X 510, then plug the USB key into the USB port on the Com'X 510 front panel.
3. Power on the Com'X 510, and wait for it to reboot. When the power LED turns green, the reboot is complete.
4. Follow steps 8 through 16 described in [Uploading a Duplicate Configuration with a Local File on page 142](#)

Upgrade Firmware

The Com'X 510 can be updated using secured firmware through the web page or the USB port on the Com'X 510 front face.

For the latest firmware update, check www.schneider-electric.com on the Com'X 510 page, or contact your local sales representative.

NOTE: Firmware upgrades can only be successful if the date and time of the Com'X 510 is correctly configured (see [Date and Time Settings on page 29](#)).

Before You Begin

- You should save a backup configuration before and after each firmware upgrade (see [Save the Configuration on page 138](#)).
- Manually push any logged data in **Commissioning > Publication > Manual publication**.

Upgrading Firmware via the Web Page

To upgrade the firmware through the web interface:

1. Save the firmware file on your laptop.
2. Click **Maintenance > System settings**.
3. Click **Browse** in the **Firmware upgrade** collapsible menu.
4. Click **Open**. The selected file appears in the field next to the **Browse** button.
5. Click **Upgrade Firmware**. The message **Application not reachable** is displayed during the upgrade.
6. Wait for the Com'X 510 to reboot. The power LED turns green when the reboot is complete.
7. Log in to the Com'X 510.
8. Check that the new firmware has been installed in the **About** page.

Upgrading Firmware via the USB Port

DANGER

HAZARD OF ELECTRIC SHOCK, EXPLOSION, OR ARC FLASH

- This equipment must only be installed and serviced by qualified personnel.
- Apply appropriate personal protective equipment (PPE) and follow safe electrical work practices. See NFPA 70E in the USA, CSA Z462 or applicable local standards.

Failure to follow these instructions will result in death or serious injury.

Follow this procedure to upgrade the firmware by using the USB port:

1. Save the firmware file at the root of the USB memory key.
2. Rename the file to `upgrade.sp1`.
3. Make sure there is no file located at the root of the USB memory key with a name that is the same as the serial number of the Com'X 510.
4. Power down the Com'X 510.
5. Insert the USB memory key in the USB port located on the front face.
6. Power up the Com'X 510.
7. Wait for the Com'X 510 to reboot. The power LED turns green when the reboot is complete.
8. Connect to the Com'X 510 through a PC and click the **About** link to check that the new firmware is installed.

Upgrading Firmware via DSP

Firmware upgrade through DSP is managed by Schneider Electric technical support.

At the end of the firmware upgrade process, the Com'X 510 reboots. Logging and publication restart automatically.

NOTE: It is not recommended to make the first firmware upgrade of the Com'X 510 using the DSP through GPRS connection. Because the GPRS connection has a speed of only 20 kb/s, the firmware update could take several hours.

Enabling Remote Access

Remote Access allows Schneider Electric support to connect remotely to a Com'X 510 to check settings and to troubleshoot without having to go to the customer site.

NOTE: Schneider Electric does not attempt connections unless required to do so. If a proxy is necessary, it must be configured.

When activated, **Remote Access** is used to create a connection between the Com'X 510 and Schneider Electric remote services.

To activate **Remote Access**:

1. Click the **Maintenance > System Settings**.
2. Under **Applications**, click the **Remote access for support** button to **ON** only if Schneider Electric support team is asking for it. Otherwise, leave the **Remote Access** button **OFF** (default).

The **Remote Access** button is deactivated three hours after you turn it on. Alternatively, you can deactivate **Remote Access** as in the steps above.

Restarting the Com'X 510 from the Web Interface

Use the **Restart Com'X** feature to manually restart the Com'X 510.

1. Click **Maintenance > System Settings**.
2. Under Restart Com'X, click Restart, then Yes to confirm. The reboot begins.

Com'X 510 Replacement

To restore the Com'X 510 configuration via a local file, replace the old Com'X 510 with the new one and use one of the methods in [Restore the Configuration on page 140](#).

Resets

Resetting the password does not affect the other configuration settings and data.

The web server is a tool for reading and writing data. It controls the state of the system, with full access to all data in your application. You will be prompted to change your password the first time you log in to prevent unauthorized access to the application.

NOTE: A secure password should not be shared or distributed to unauthorized personnel. The password should not contain any personal or obvious information.

The new password must contain:

- 8 characters
- 1 uppercase letter
- 1 numeric digit
- 1 special character

Resetting the Password Locally

If you lose the password, follow this procedure to reset the default administrator password to factory values:

NOTE: The password reset function must be enabled. See [Disabling the Com'X 510 Password Reset Button on page 60](#) to check the status of the password reset function.



1. Press the **Backup** button  on the Com'X 510 front face and hold it for at least 10 s until the power LED flashes green three times.
2. Release the button.
3. To access to the Com'X 510 configuration web pages, use these settings:
 - Username: *admin*
 - Password: *admin*

Resetting to Factory Settings

NOTICE

HAZARD OF IP ADDRESS CONFLICT



Disconnect the Com'X 510 from any Ethernet networks before resetting the IP settings to factory values.

Failure to follow these instructions can result in impaired communications.

When following the procedure below, all data and logs that have been stored are erased.

NOTE: If you are using a Schneider Electric Service through DSP, contact Schneider Electric support before performing a factory reset. Otherwise, you must contact DSP support to reconnect to your subscribed service: dsp-support@schneider-electric.com.

To reset the Com'X 510 completely, follow this procedure to set all configuration settings to factory values:

1. Power down the Com'X 510 and wait until the power LED is off.
2. Press simultaneously the **Backup** button  and the **Wi-Fi** button  on the Com'X 510 front face and power up the Com'X 510. Hold the buttons for at least 10 s until the power LED flashes three times.
3. Release the buttons. The Com'X 510 reboots.
4. Wait for the Com'X 510 to restart completely. The power LED is:
 - orange when the Com'X 510 is starting.
 - green when the Com'X 510 has been reset to factory settings and is ready to be configured.
5. Follow the instructions described in [Access the Com'X 510 User Interface on page 17](#) to access the Com'X 510 web pages.

Checklist Before Leaving Customer Site

This list is not exhaustive.

Schneider Electric recommends using this checklist before leaving customer site.

Checkpoint	Done	Comments
Logging is ON in the banner.		
Publication is ON in the banner (if applicable).		
Each meter returns relevant values in the Measurements Table and Real Time Data tabs.		
Each analog sensor returns relevant values in the Measurements Table.		
No notification icon is in the Measurements Table.		
For Ethernet connections, the LED eth1 and/or eth2 is blinking.		
For GPRS or 3G connections, the wireless connection has a reception level at least equal to 2/4.		
For GPRS or 3G connections, check the LED and the general status.		
For Wi-Fi connections, the wireless connection has a good reception level.		
For Wi-Fi connections, check the LED and the general status.		
The last publication to the platform has to be successful (if applicable).		

Troubleshooting

Metering Device Troubleshooting

 DANGER	
HAZARD OF ELECTRIC SHOCK, EXPLOSION, OR ARC FLASH	
<ul style="list-style-type: none"> • This equipment must only be installed and serviced by qualified personnel. • Apply appropriate personal protective equipment (PPE) and follow safe electrical work practices. See NFPA 70E in the USA, CSA Z462 or applicable local standards. 	
Failure to follow these instructions will result in death or serious injury.	

Digital Input Troubleshooting

This table describes how to solve issues with digital inputs.

Issue	Possible Solution
No pulse is received. The digital input LED is not flashing.	Bridge the input terminals between the terminal and the 12 V power supply with a short piece of wire to confirm that the LED is working. If the input LED lights up when you bridge the input terminals, the issue is likely with the meter and/or the wiring to the meter.
	Check that the pulse output meter is connected to a digital input terminal and the 12 V power supply.
	Refer to the <i>Installation Guide</i> for wiring diagrams.
	Check that the pulse output device is operating.
No pulse is received. The digital input LED is flashing.	Check the digital input number to which the pulse meter is connected.

Analog Input Troubleshooting

This table describes how to solve issues with analog inputs.

Issue	Possible Solution
No analog value can be read.	Check that the analog output sensor is connected to the proper terminals.
	Refer to the <i>Installation Guide</i> for wiring diagrams.
	In the configuration web page, check that the analog input number is set to the correct type of sensor: RTD, 0–10 V, or 4–20 mA.

Modbus Device Troubleshooting

⚠ DANGER

HAZARD OF ELECTRIC SHOCK, EXPLOSION, OR ARC FLASH

- This equipment must only be installed and serviced by qualified personnel.
- Apply appropriate personal protective equipment (PPE) and follow safe electrical work practices. See NFPA 70E in the USA, CSA Z462 or applicable local standards.

Failure to follow these instructions will result in death or serious injury.

This table describes how to solve issues with Modbus devices.

Issue	Possible Solution
No Modbus device can be detected on the Com'X 510 serial line.	<ol style="list-style-type: none"> 1. Open the Measurements Table main tab of the Com'X 510. 2. If the Rx communication LED does not flash on the device, check the wiring integrity. 3. If the Rx communication LED flashes on the device, but the Tx communication LED does not flash on the device: <ul style="list-style-type: none"> • check that the device settings match the Com'X 510 Modbus serial settings (Baud rate, Parity, and Number of stop bits). • check that the Serial line polarization is set to Yes. • check that the Serial line polarization is not activated on another Modbus slave device on the same serial line.

Issue	Possible Solution
Some Modbus devices are missing on the Com'X 510 serial line.	Check the Modbus addresses of the missing devices.
	Check that two devices do not have the same slave ID.
	Check that the settings of the missing devices match the Com'X 510 Modbus serial settings (Baud rate , Parity , and Number of stop bits).
	Check that the wiring connections of the missing devices are correct.
	Check that the discovery range is large enough. The factory settings range from 1 to 10.
	Check that the wiring of the missing devices is correct.
No Modbus device can be detected downstream from a gateway.	<p>Use the Diagnostic/Read Device Registers feature of the EGX to determine if the issue is between Modbus device and the EGX or between the Com'X 510 and the EGX.</p> <p>If the issue is located between</p> <ul style="list-style-type: none"> • the Com'X 510 and the EGX, check the IP address of the gateway. • the EGX and the Modbus device, check that the Modbus device settings match the EGX serial port setup (Baud rate, Parity, and Number of stop bits). <p>The combination (Parity = none and Number of stop bits = 1) of port settings is not supported by the EGX. Change to another combination.</p>

Network Troubleshooting

DANGER

HAZARD OF ELECTRIC SHOCK, EXPLOSION, OR ARC FLASH

- This equipment must only be installed and serviced by qualified personnel.
- Apply appropriate personal protective equipment (PPE) and follow safe electrical work practices. See NFPA 70E in the USA, CSA Z462 or applicable local standards.

Failure to follow these instructions will result in death or serious injury.

Ethernet Troubleshooting

This table describes how to solve issues with Ethernet.

Issue	Possible Solution
Ethernet LEDs are not blinking.	Check that the Ethernet LAN cables are not disconnected.
Cannot access to Modbus devices downstream from a Modbus TCP/Modbus serial line gateway.	Check the IP address of the gateway. If data export is via GPRS/3G, check that the gateway is on the same Ethernet subnetwork as the Com'X 510.

GPRS/3G Troubleshooting

This table describes how to solve issues with GPRS or 3G.

Issue	Possible Solution
Modem is not detected. The LED modem is not flashing.	Power down the Com'X 510. Reinsert the modem and power up the Com'X 510.
Modem cannot connect to the network.	Check that the settings such as the APN are correct.
GPRS LED on front panel turns ON and OFF periodically.	Check that protocol settings are correct in General Setting > Publication .

Wi-Fi Troubleshooting

This table describes how to solve issues with Wi-Fi.

Issue	Possible Solution
Wi-Fi USB key is not detected. The USB key LED is not flashing.	Power down the Com'X 510. Reinsert again the Wi-Fi USB key and power up the Com'X 510.
Wi-Fi USB key cannot connect to the network.	Check that the settings such as the SSID name and the WPA2 key are correct.

Com'X 510 Troubleshooting

Com'X 510 Access

This table describes how to solve issues when accessing the Com'X 510.

Issue	Possible Solution
Cannot log in through customer LAN.	Log in to the Com'X 510. Follow the procedures described in Logging In for the First Time on page 21 . Check the IP address.
Lost password	Follow the procedure in Resets on page 145 to reset the password.

Web Pages

This table describes how to solve issues when viewing the Com'X 510 web pages.

Issue	Possible Solution
The web pages are not displayed correctly.	Check the screen resolution of your laptop. It must be set to at least 1280x1024.
	In Internet Explorer, check that the Display intranet sites in compatibility view box is disabled by selecting View settings compatibility in the Tools tab of Internet Explorer.
	Delete browsing history.

Digital Service Platform Selection

This table describes how to solve issues when connecting to Digital Service Platform.

Issue	Possible Solution
Network error message displayed when selecting Digital Service Platform.	<p>If an Ethernet connection is used for publication, check:</p> <ul style="list-style-type: none"> the IP settings in the Settings > General Settings > Network Settings page. the proxy settings in the Settings > General Settings > Proxy Settings page. <p>If a GPRS/3G connection is used for publication, check the GPRS/3G signal level and adjust the antenna position accordingly.</p>
Publication to the platform was unsuccessful.	<p>The Com'X 510 needs access to a DNS server.</p> <p>The web provider must accept <i>SRV</i> DNS requests.</p> <p>The following URLs must be accessible:</p> <ul style="list-style-type: none"> cnm-ih-na.azure-devices.net/' bootstrap.gl.struxurewarecloud.com https://remoteshell.rsp.schneider-electric.com:443

Data Publishing

This table describes how to solve issues when publishing data:

Issue	Possible Solution
Publication to the platform was unsuccessful.	<ul style="list-style-type: none"> • Check the platform user name and the password. • Check the Com'X 510 date and time.
Publication to the platform was unsuccessful with Ethernet or Wi-Fi.	Check if a proxy is implemented on the network. If so, refer to Proxy Settings on page 39 for further information.
The Com'X 510 connects to the FTP server but does not succeed in delivering the data file.	Check that your FTP account has the right to rename a file on the FTP server.

Firmware Upgrade

This table describes how to solve issues when upgrading firmware

Issue	Possible Solution
Firmware is not upgraded when managed through USB memory key plugged on front panel.	Delete the file DNxxxxxxxxxxxx-xxx (where xxxxxxxxxxxxxx-xxx is the serial number of the Com'X 510) registered at the root directory of the USB memory key.

Events

This table describes how to solve issues when sending events:

Issue	Possible Solution
Facility Insights is not receiving events from the Com'X 510.	<ul style="list-style-type: none"> • Check that Schneider Electric Services is enabled. • Check that generated events are incrementing in Maintenance > Events. • Check the Last delivery status in Maintenance > Events. • Check the comms status of each device in Diagnostics > Communications Check.

Appendices

Appendix A: Publish Data to Energy Operation

Use the following chapter as a tutorial for setting up the Com'X 510 for use with Energy Operation.

⚠ WARNING
<p>INACCURATE DATA RESULTS</p> <ul style="list-style-type: none"> Do not incorrectly configure the software, as this can lead to inaccurate reports and/or data results. <p>Failure to follow these instructions can result in death, serious injury, equipment damage, or permanent loss of data.</p>

Quick Start Overview

The quick start guide describes the configuration for these simple installations:

- publication to Schneider Electric Energy Operation through Ethernet or GPRS/3G.
- metering devices connected directly to the Com'X 510.

Example: Data Used for Publication

This table is an example of the fields used for the publication:

Field	Data Used
Customer	Whale company
Site location name	Marseilles office
Country	France
Destination platform	Energy Operation
Subscription	Option 1: Ethernet connection
	Option 2: Schneider Electric GPRS option

Data Logger

This table provides information on the Com'X 510:

Device Type	IP Address	Device Location
Com'X 510	Assigned by DHCP server	Main switchboard

Devices Used for Data Acquisition

This table provides information on digital input devices used for data acquisition:

Device Type	Connection	Pulse Weight	Device Location	Monitored Area	Usage	Measurements to Log and Publish
iEM2000T energy meter	Digital input DI1	0.01 kWh	Sub-switchboard 1	Level 1	Lighting	Active energy
iEM3210 energy meter	Digital input DI2	0.01 kWh	Sub-switchboard 2	Level 2	Lighting	Active energy

This table provides information on analog input devices used for data acquisition:

Device Type	Connection	Device Location	Monitored Area	Usage	Measurements to Log and Publish
Pt100 temperature probe	Analog input AI1	North outdoor	Outdoor	Not applicable	Temperature
TAC SHR100 humidity sensor 4–20 mA	Analog input AI2	North outdoor	Outdoor	Not applicable	Humidity

This table provides information on Modbus devices used for data acquisition:

Device Type	Slave Address	Device Location	Monitored Area	Usage	Measurements to Log and Publish
Masterpact with Micrologic P control unit	1	Main switchboard	General building	Main meter	Active energy
Compact NSX with Micrologic E control unit	2	Sub-switchboard 1	Level 1 - West	Ventilation	Active energy
PM710 power meter	3	Sub-switchboard 2	Level 2 - West	Computer room	Active energy
PM3250 power meter	4	Sub-switchboard 2	Level 2 - East	Ventilation	Active energy

Summary Diagram

This diagram summarizes the information required for data publication:

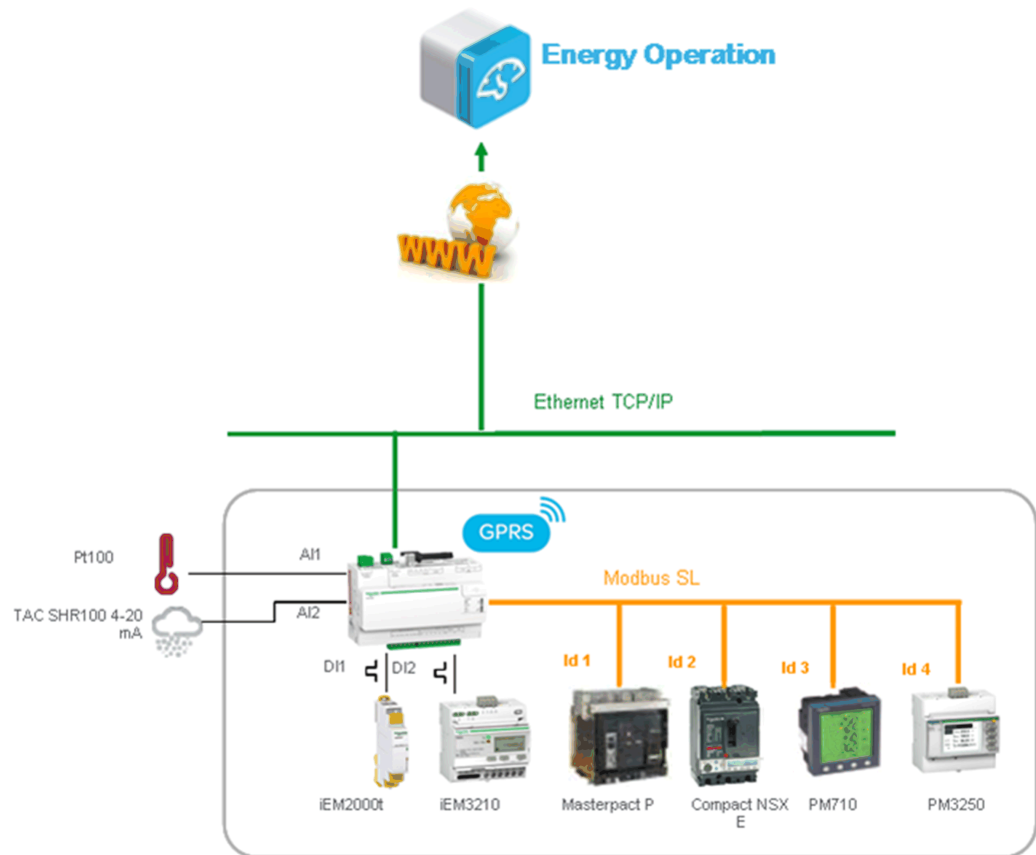

Define the Initial and Site Settings

1. [Configuring Site Information on page 158](#)
2. [Configuring Date and Time Settings on page 159](#)
3. [Defining the Logging Intervals on page 159](#)
4. [Configuring Publication Settings on page 159](#)

Configuring Site Information

Site Information defines the site location name where metering is taking place.

This information is used by Energy Operation as a site name under which all measurements are assigned.

To change the site name:

1. Click **Settings > General Settings > Site Information**.
2. Enter the site location name.

NOTE: The site name must not include any of these characters: '/*?<>| or space.

3. Click **Save changes**.

Configuring Date and Time Settings

To set the date and time:

1. Click **Settings > General Settings > Date/Time Settings**.
2. Select the appropriate **Timezone** in the drop-down list. If the DST time zone is selected, the clock will automatically adjust for Daylight Saving Time.
3. Click **Save changes**.
4. Click the **Today** button to set the date and time automatically with the date and time of your computer.

Defining the Logging Intervals

Follow this procedure to set the logging intervals:

1. Click **Settings > Site Settings > Data Logging**.
2. Select your country.

NOTE: This will automatically set the logging intervals of data for different commodities in the country.

3. Click **Save changes**.

Configuring Publication Settings

Follow this procedure to set the Energy Operation data publication settings using **FTP**:

1. Click **Settings > General Settings > Publication**.
2. Select **Energy Operation** in the **Destination platform** drop-down list.
3. Select **HTTPS** in the **Protocol** drop-down list.

NOTE: The server and port are preconfigured.

4. Type the username and the password of the HTTPS server. This information is given with the Energy Operation subscription contract. Contact the Schneider Electric representative to provide you with this information.
5. Click **Save changes**.

NOTE: Refer to [Define the Transfer Protocol on page 42](#) to use another transfer protocol such as HTTP or FTP.

Define the Network Settings to Publish Data

The Ethernet network port 1  has to be connected to the local network. Eth1 LED blinks when the connection is successful.

The Ethernet port 1 is set to DHCP client by default. Therefore, the Com'X 510 obtains the IP address automatically from an existing DHCP server.

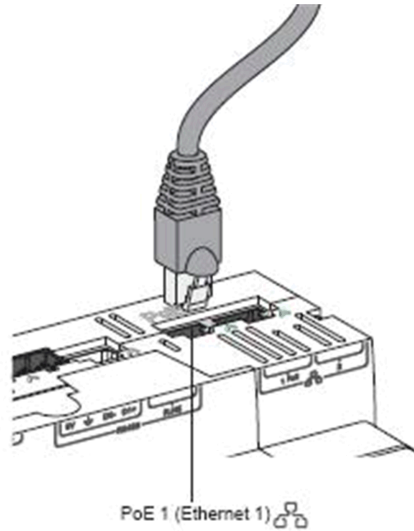

Next, you must set up data publication: [Configuring Data Publication Over Ethernet on page 160](#) or [Configuring Data Publication Over GPRS/3G on page 161](#)

Configuring Data Publication Over Ethernet

This graphic shows the interface of the network settings:

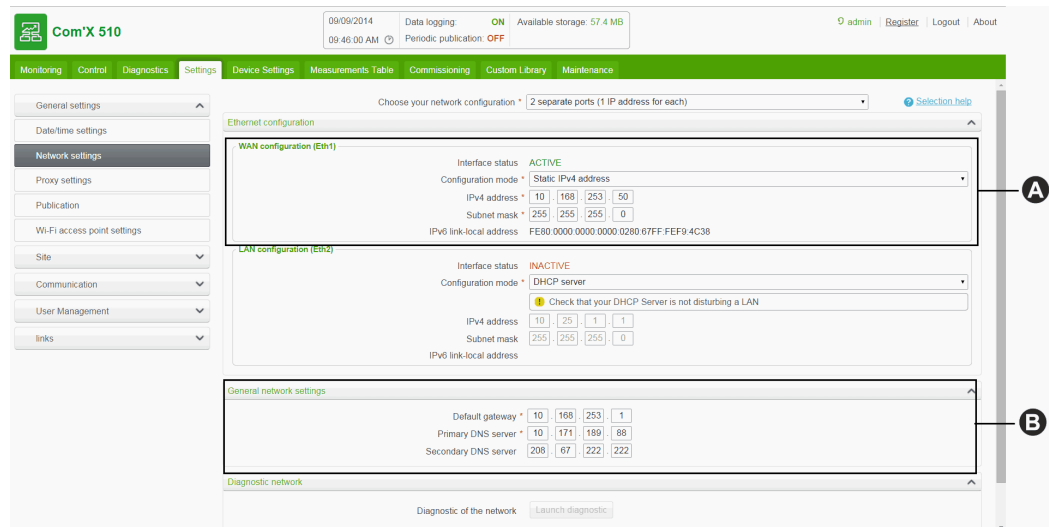

A	Ethernet configuration
B	General network settings







Follow this procedure to view the network parameters assigned to Ethernet port 1:

1. Click **Settings > General Settings > Network Settings**.
2. Select **2 Separate ports (1 IP address for each)** in the **Choose your network configuration** drop-down list. Network parameters are displayed in the **Ethernet configuration** and **General network settings** collapsible menus. The port status is **ACTIVE** in the **WAN configuration (eth1)**.
3. To enable ping replies, select **Yes** in **General network settings > Reply to ping**. Reply to ping is disabled by default.
4. Click **Save changes**.

Configuring Data Publication Over GPRS/3G

A GPRS or 3G modem with a SIM card must be plugged into the Com'X 510 for GPRS/3G communication. The modem LED flashes every five seconds if correctly detected.

1. Click **Settings > General Settings > Network Settings**.
2. Click **GPRS/3G only** in the **Network configuration** drop-down list.
3. Type the **APN** provided with the SIM card.
4. Type the **username**, **password**, and **PIN code** if provided by the operator.
5. Click **Save changes**.
6. Check if the GPRS or 3G modem is activated. When connected, the modem LED is static with a color that depends on the GPRS or 3G signal level as shown below. Check the status of the GPRS or 3G modem and signal level on the banner.

	No modem detected
	Modem detected
	Modem not connected to a network
	Weak signal level (red)
	Medium signal level (yellow)
	High signal level (green)

Define the Metering Devices

Adding a Digital Input

This graphic shows the interface when adding a digital input:

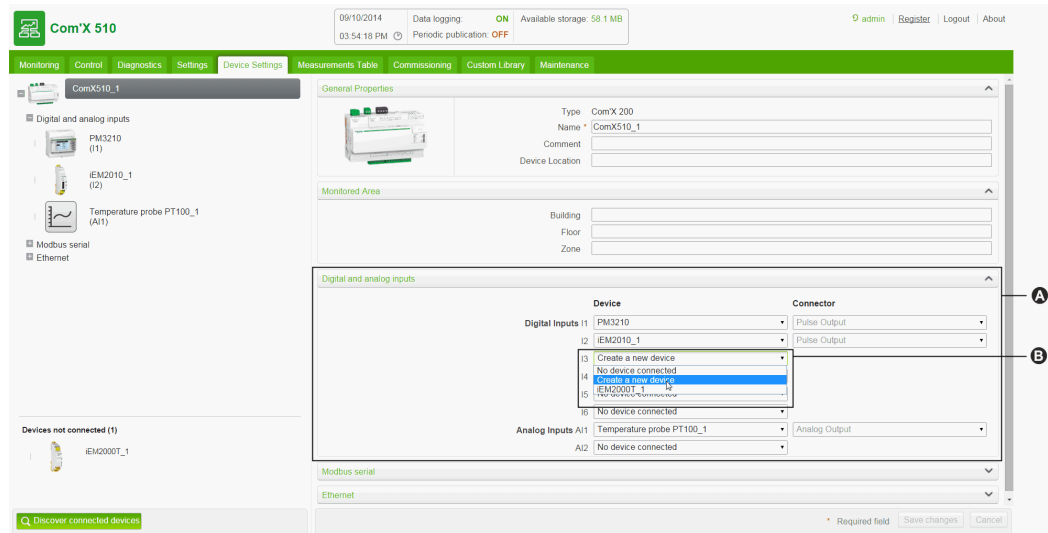

A	Digital and analog inputs collapsible menu
B	Device drop-down list

Follow this procedure to add a device on a digital input (for example, iEM2000T pulse meter):

1. Click the **Device Settings** main tab.
2. Click the Com'X 510 in the device tree view.
3. In the **Digital and analog inputs** collapsible menu, select **Create a new device** on the digital input to which the pulse meter is connected.
4. In the pop-up window, select the Schneider Electric **Device Type** (iEM2000T) in the drop-down list.
5. Fill in the **General Properties** collapsible menu with
 - **Name:** iEM2000T_1
 - **Comment:** none
 - **Commodity:** electricity
 - **Device Location:** sub-switchboard 1
 Refer to [Common Properties on page 75](#) for further information.
6. Fill in the **Monitored Area** with
 - **Building:** Marseilles office
 - **Floor:** 1
 - **Zone:** west
 - **Usage:** lighting
 Refer to [Common Properties on page 75](#) for further information.
7. Fill in the **Measurements Properties** collapsible menu with

- **Pulse weight (Wh):** 10
- **Offset (Wh):** 0.0
- **Upper Range (Wh):** 1000000000

The list is restricted to the values that correspond to the selected device type. If there is only 1 possible pulse weight, the value is automatically set as for the iEM2000T pulse meter.

8. Click **Create** and the new device appears in the device tree view.
9. In the device tree view, click the digital input to view the device parameters and measurements. The active energy is selected by default to be logged and published.

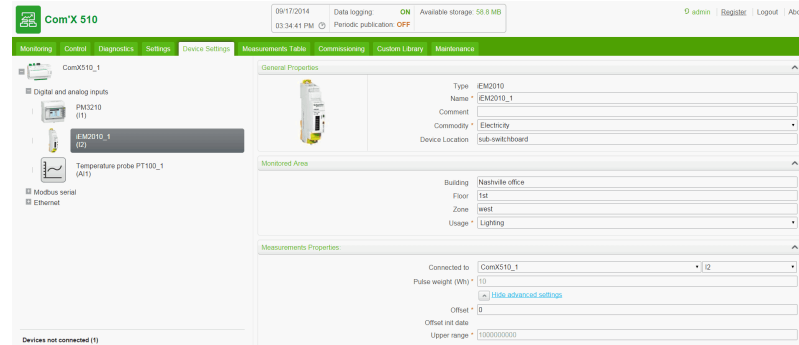

10. Repeat steps 3 through 9 to add other digital input devices.

Adding an Analog Input

Follow this procedure to add an analog input (for example, Pt100 temperature probe):

1. Click the **Device Settings** main tab.
2. Click the Com'X 510 in the device tree view.
3. In the **Digital and analog inputs** collapsible menu, select **Create a new device** on the analog input to which the analog sensor is connected.
4. In the pop-up window, select the Schneider Electric **Device Type** (Pt100 temperature probe) in the drop-down list.
5. Fill in the **General Properties** collapsible menu with
 - **Name:** Temperature probe PT100_1
 - **Comment:** none
 - **Commodity:** environmental parameters
 - **Device Location:** north outdoor

Refer to [Common Properties on page 75](#) for further information.
6. Fill in the **Monitored Area** with
 - **Building:** Marseilles office
 - **Floor:** 1

- **Zone:** outdoor
- **Usage:** main meter

Refer to [Common Properties on page 75](#) for further information.

7. Click **Create** and the new device appears in the device tree view.
8. In the device tree view, click the analog sensor to view the device parameters and measurements.

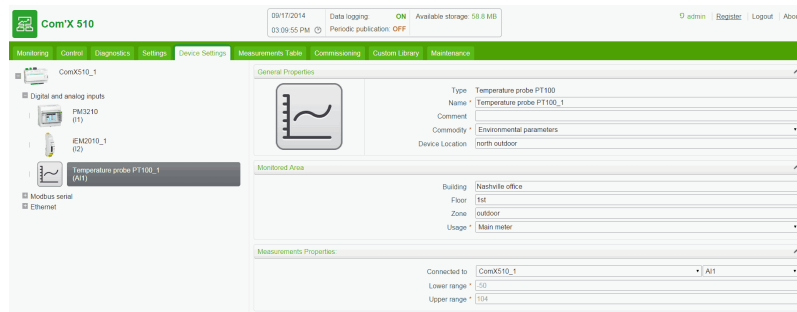

9. Repeat steps 3 through 9 to add other analog input devices.

Discovering Connected Devices

The Com'X 510 can discover Modbus devices that are connected locally to the serial port using the **Modbus Discovery** function.

Follow this procedure to discover connected Schneider Electric Modbus serial meters:

1. Click the **Device Settings** main tab.
2. Click the Com'X 510 in the device tree view.
3. Click **Discover connected devices** on the bottom left. This opens a **Modbus Discovery** pop-up window.
4. Enter a **Slave ID min** and **Slave ID max**. The default range is 1 to 10, and the allowable range is 1 to 247.
5. Click **Start** to scan the connected devices that are displayed in a list.
6. Deselect any devices you do not want to add, then click **Create**, and all the discovered devices appear in the device tree view.

Click a device to view the device parameters and measurements. The device name and the measurement to be logged and published can be modified as in [Modbus Devices on page 85](#).

Adding a Schneider Electric Modbus Serial Device

Modbus devices that are not connected locally cannot be discovered, but they can be added manually using the following procedure.

This graphic shows the interface when adding a Modbus serial device:

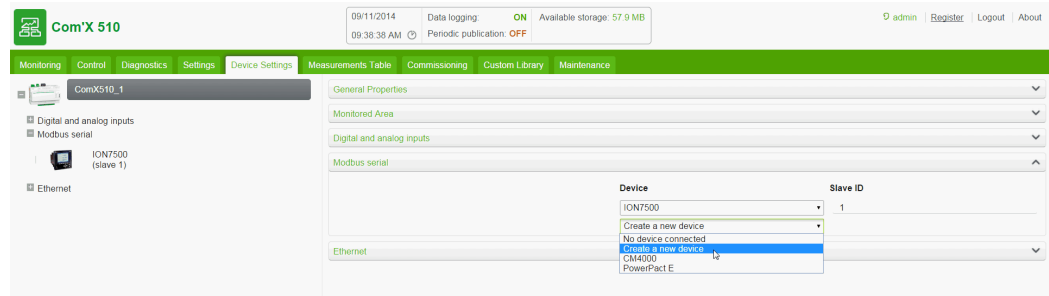

Follow this procedure to add a Modbus serial device (for example, PM710 meter):

1. Click the **Device Settings** main tab.
2. Click the Com'X 510 in the device tree view.
3. In the **Modbus Serial** collapsible menu, select **Create a new device** on the input to which the serial meter is connected.
4. In the pop-up window, select Schneider Electric **Device Type** (PM710 meter) from the drop-down list.
5. Fill in the **General Properties** collapsible menu with
 - **Name:** PM710_1
 - **Comment:** none
 - **Commodity:** electricity
 - **Device Location:** sub-switchboard 2
 Refer to [Common Properties on page 75](#) for further information.
6. Fill in the **Configuration** collapsible menu with the **Slave ID:** 1.
7. Fill in the **Monitored Area** with
 - **Building:** Marseilles office
 - **Floor:** 2
 - **Zone:** west
 - **Usage:** computer room
 Refer to [Common Properties on page 75](#) for further information.
8. Click **Create** and the new device appears in the device tree view.
9. In the device tree view, click the Modbus serial devices to view the device parameters and measurements.

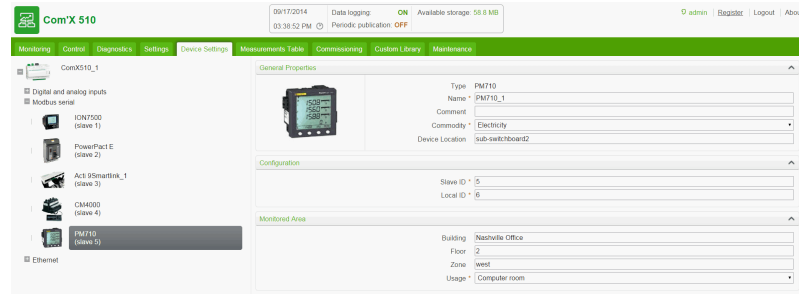

10. Repeat steps 3 through 9 to add other Modbus serial devices.

Visualize the Data to Publish

Click the **Measurements Table** tab to display the measurements selected.

By default, active and reactive energies, indexes and environmental parameters are automatically published to the selected platform.

Publishing the Data to Energy Operation

The **Commissioning** tab allows you to start/stop the data logging and publication to Energy Operation.

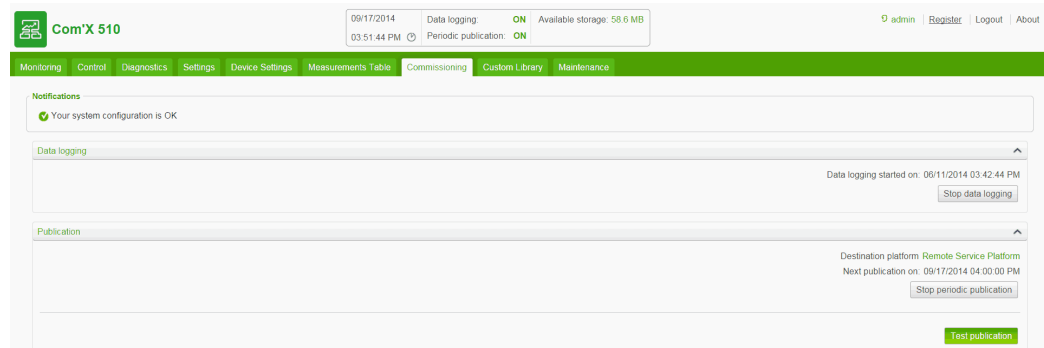

Follow this procedure to publish periodically to Energy Operation:

1. Click **Commissioning** main tab.
2. View the **Notifications** area for the status of your configuration. If any requested field or parameters are missing, a link to the corresponding tab is displayed. Click the link to be redirected to the tab.
3. Click **Start data logging**. Activates the logging of selected data from devices to be retrieved, stored, and published.
4. Click **Send full topology**. Sends the metering architecture, associated with a meter or sensor, to Energy Operation. See [Common Properties on page 75](#) for more information on metering architecture.

NOTE: If the topology is not sent to Energy Operation, a flat list of meters is created under a site named `Site Newmeters`.

5. Click **Test publication** to send data to Energy Operation.
6. Click **Start publication** to send data to Energy Operation according to the frequency set in **Publication settings** (See [Configuring Publication Settings on page 159](#)). The next publication time is displayed.

Appendix B: Replacing the SD Card

DANGER

HAZARD OF ELECTRIC SHOCK, EXPLOSION, OR ARC FLASH

- This equipment must only be installed and serviced by qualified personnel.
- Apply appropriate personal protective equipment (PPE) and follow safe electrical work practices. See NFPA 70E in the USA, CSA Z462 or applicable local standards.

Failure to follow these instructions will result in death or serious injury.

NOTICE

LOST DATA OR DATA CORRUPTION

Power down the Com'X 510 before inserting or removing the SD card. Otherwise, the Com'X 510 will lose the ability to log and publish data.

Failure to follow these instructions will result in lost or corrupt data.

All data logged by the Com'X 510 is stored on the SD card. Data is lost when you replace the SD card, which affects your ability to view historical data on board. We recommend backing up the data if possible before replacing the SD card. (see [Publication on page 41](#))

Contact Schneider Electric technical support to order the supported replacement SD card.

To replace the SD card:

1. Power down the Com'X 510.
2. Open the front cover and push down to remove the SD card.
3. Insert the new SD card.
4. Close the front cover and power up the Com'X 510.
5. Log in to the Com'X 510 and verify that the available storage in the banner reflects the SD card capacity.

Appendix C: List of Supported Devices

Supported device types are described in the firmware release package. Go to www.myenergyserver.com or www.schneider-electric.com for the most current list of supported device types.

Appendix D: List of Certificate Authorities

This table describes the list of certificate authorities uploaded in the Com'X 510.

Certificate Name	Owner User	Owner	Locality/ State	Country
DigiCert Assured ID Root CA	www.digicert.com	DigiCert Inc	–	US
TC TrustCenter Class 2 CA II	TC TrustCenter Class 2 CA	TC TrustCenter GmbH	–	DE
Thawte Premium Server CA OID.1.2.840.113549.1.9.1=premium-server@thawte.com	Certification Services Division	Thawte Consulting cc	Cape Town/Western Cape	ZA
SwissSign Platinum CA - G2	–	SwissSign AG	–	CH
SwissSign Silver CA - G2	–	SwissSign AG	–	CH
Thawte Server CA OID.1.2.840.113549.1.9.1=server-certs@thawte.com	Certification Services Division	Thawte Consulting cc	Cape Town/Western Cape	ZA
Equifax Secure eBusiness CA-1	–	Equifax Secure Inc.	–	US
UTN-USERFirst-Client Authentication and Email	http://www.usertrust.com	The USERTRUST Network	Salt Lake City/UT	US
Thawte Personal Freemail CA OID.1.2.840.113549.1.9.1=personal-freemail@thawte.com	Certification Services Division	Thawte Consulting	Cape Town/Western Cape	ZA
Entrust Root Certification Authority	www.entrust.net/CPS is incorporated by reference, (c) 2006 Entrust, Inc.	Entrust, Inc.	–	US
UTN-USERFirst-Hardware	http://www.usertrust.com	The USERTRUST Network	Salt Lake City/UT	US
Certum CA	–	Unizeto Sp. z o.o.	–	PL
AddTrust Class 1 CA Root	AddTrust TTP Network	AddTrust AB	–	SE

Certificate Name	Owner User	Owner	Locality/ State	Country
Entrust Root Certification Authority - G2	See www.entrust.net/legal-terms , (c) 2009 Entrust, Inc.”(1)	Entrust, Inc.	–	US
Equifax Secure Certificate Authority	–	Equifax	–	US
QuoVadis Root CA 3	–	QuoVadis Limited	–	BE
QuoVadis Root CA 2	–	QuoVadis Limited	–	BE
DigiCert High Assurance EV Root CA	www.digicert.com	DigiCert Inc	–	US
http://www.valicert.com OID.1.2.840.113549.1.9.1=info@valicert.com	ValiCert Class 1 Policy Validation Authority	ValiCert, Inc.	ValiCert Validation Network	–
Equifax Secure Global eBusiness CA-1	–	Equifax Secure Inc.	–	US
GeoTrust Universal CA	–	GeoTrust Inc.	–	US
thawte Primary Root CA - G3	Certification Services Division, (c) 2008 thawte, Inc.(1)	thawte, Inc.	–	US
–	Class 3 Public Primary Certification Authority	VeriSign, Inc.	–	US
thawte Primary Root CA - G2	(c) 2007 thawte, Inc.(1)	thawte, Inc.	–	US
Deutsche Telekom Root CA 2	T-TeleSec Trust Center	Deutsche Telekom AG	–	DE
UTN-USERFirst-Object	http://www.usertrust.com	The USERTRUST Network	Salt Lake City/UT	US
GeoTrust Primary Certification Authority	–	GeoTrust Inc.	–	US
Baltimore CyberTrust Code Signing Root	CyberTrust	Baltimore	–	IE
–	Class 1 Public Primary Certification Authority	VeriSign, Inc.	–	US
Baltimore CyberTrust Root	CyberTrust	Baltimore	–	IE
–	Starfield Class 2 Certification Authority	Starfield Technologies, Inc.	–	US

Certificate Name	Owner User	Owner	Locality/ State	Country
Chambers of Commerce Root	http://www.chambersign.org	AC Camerfirma SA CIF A82743287	–	EU
T-TeleSec GlobalRoot Class 3	T-Systems Trust Center	T-Systems Enterprise Services GmbH	–	DE
VeriSign Class 3 Public Primary Certification Authority - G5	VeriSign Trust Network, (c) 2006 VeriSign, Inc. (1)	VeriSign, Inc.	–	US
T-TeleSec GlobalRoot Class 2	T-Systems Trust Center	T-Systems Enterprise Services GmbH	–	DE
TC TrustCenter Universal CA I	TC TrustCenter Universal CA	TC TrustCenter GmbH	–	DE
VeriSign Class 3 Public Primary Certification Authority - G4	VeriSign Trust Network, (c) 2007 VeriSign, Inc. (1)	VeriSign, Inc.	–	US
VeriSign Class 3 Public Primary Certification Authority - G3	VeriSign Trust Network, (c) 1999 VeriSign, Inc. (1)	VeriSign, Inc.	–	US
Class 3P Primary CA	–	Certplus	–	FR
Certum Trusted Network CA	Certum Certification Authority	Unizeto Technologies S.A.	–	PL
Class 3 Public Primary Certification Authority - G2	VeriSign Trust Network, (c) 1998 VeriSign, Inc. (1)	VeriSign, Inc.	–	US
GlobalSign	GlobalSign Root CA - R3	GlobalSign	–	–
UTN - DATACorp SGC	http://www.usertrust.com	The USERTRUST Network	Salt Lake City/UT	US
–	Security Communication RootCA2	SECOM Trust Systems CO., LTD.	–	JP

Certificate Name	Owner User	Owner	Locality/ State	Country
GTE CyberTrust Global Root	GTE CyberTrust Solutions, Inc.	GTE Corporation	–	US
–	Security Communication RootCA1	SECOM Trust.net	–	JP
TC TrustCenter Class 4 CA II	TC TrustCenter Class 4 CA	TC TrustCenter GmbH	–	DE
VeriSign Universal Root Certification Authority	VeriSign Trust Network, (c) 2008 VeriSign, Inc. (1)	VeriSign, Inc.	–	US
GlobalSign	GlobalSign Root CA - R2	GlobalSign	–	–
Class 2 Primary CA	–	Certplus	–	FR
DigiCert Global Root CA	www.digicert.com	DigiCert Inc	–	US
GlobalSign Root CA	Root CA	GlobalSign nv-sa	–	BE
thawte Primary Root CA	Certification Services Division, (c) 2006 thawte, Inc.(1)	thawte, Inc.	–	US
GeoTrust Global CA	–	GeoTrust Inc.	–	US
Sonera Class2 CA	–	Sonera	–	FI
Thawte Timestamping CA	Thawte Certification	Thawte	Durbanville/Western Cape	ZA
Sonera Class1 CA	–	Sonera	–	FI
QuoVadis Root Certification Authority	Root Certification Authority	QuoVadis Limited	–	BM
http://www.valicert.com OID.1.2.840.113549.1.9.1=info@valicert.com	ValiCert Class 2 Policy Validation Authority	ValiCert, Inc.	–	–
AAA Certificate Services	–	Comodo CA Limited	Salford/Greater Manchester	GB
AddTrust Qualified CA Root	AddTrust TTP Network	AddTrust AB,C	–	SE
KEYNECTIS ROOT CA	ROOT	KEYNECTIS	–	FR

Certificate Name	Owner User	Owner	Locality/ State	Country
America Online Root Certification Authority 2	–	America Online Inc.	–	US
VeriSign Class 2 Public Primary Certification Authority - G3	VeriSign Trust Network, (c) 1999 VeriSign, Inc. (1)	VeriSign, Inc.	–	US
AddTrust External CA Root	AddTrust External TTP Network	AddTrust AB,C	–	SE
America Online Root Certification Authority 1	–	America Online Inc.	–	US
Class 2 Public Primary Certification Authority - G2	VeriSign Trust Network, (c) 1998 VeriSign, Inc. (1)	VeriSign, Inc.	–	US
GeoTrust Primary Certification Authority - G3	(c) 2008 GeoTrust Inc. (1)	GeoTrust Inc.	–	US
GeoTrust Primary Certification Authority - G2	(c) 2007 GeoTrust Inc. (1)	GeoTrust Inc.	–	US
SwissSign Gold CA - G2	–	SwissSign AG	–	CH
Entrust.net Certification Authority (2048)	www.entrust.net/CPS_2048 incorp. by ref. (limits liab.), (c) 1999 Entrust.net Limited	Entrust.net	–	–
GTE CyberTrust Root 5	GTE CyberTrust Solutions, Inc.	GTE Corporation	–	US
Global Chambersign Root - 2008, OID.2.5.4.5=A82743287	–	AC Camerfirma S.A.	Madrid(2)	EU
Chambers of Commerce Root - 2008, OID.2.5.4.5=A82743287	–	AC Camerfirma S.A.	Madrid(2)	EU
–	Go Daddy Class 2 Certification Authority	The Go Daddy Group, Inc.	–	US
Entrust.net Secure Server Certification Authority	www.entrust.net/CPS incorp. by ref. (limits liab.), (c) 1999 Entrust.net Limited	Entrust.net	–	US
VeriSign Class 1 Public Primary Certification Authority - G3	VeriSign Trust Network, (c) 1999 VeriSign, Inc. (1)	VeriSign, Inc.	–	US

Certificate Name	Owner User	Owner	Locality/ State	Country
–	Security Communication EV RootCA1	SECOM Trust Systems CO., LTD.	–	JP
Zscaler	Zscaler Inc.	www.zscaler.com	Santa Clara/CA	US
Zscaler Inc. Root CA OID.1.2.840.113549.1.9.1=support@zscaler.com	zscaler.net	Zscaler Inc.	Sunnyvale/California	US
(1) For authorized use only				
(2) See current address at www.camerfirma.com/address				

Appendix E: IPv4 Address Settings

The Com'X 510 supports three different operating modes for assigning the IP address:

- Static IPv4 (see [Static IP Settings on page 176](#))
- DHCP client (see [DHCP Client on page 176](#))
- DHCP server (see [DHCP Server Over Ethernet Port on page 177](#) or [DHCP Server Over Wi-Fi on page 177](#))

Static IP Settings

In the Com'X 510, you can define the IPv4 addresses of the Ethernet interface, subnet mask, and default gateway. These settings must be consistent with the network policy of the site. The IT administrator of the site should be contacted to provide this information.

DHCP Client

You can configure the Com'X 510 so that the IPv4 address is automatically set by the DHCP server facility. The IT administrator of the site can be asked to configure the DHCP server to systematically assign the same IPv4 address to the Com'X 510.

Follow this procedure to get a fixed IPv4 address with DHCP server:

1. Provide the local IT manager with the MAC address of the Com'X 510 Ethernet port 1. The address can be found on the label on the front face of the device or in the **About** page.
2. Ask the IT manager to provide a fixed IPv4 address so that the same IP address is always assigned to the Com'X 510. The IP address is to be given by the IT manager.
3. Write down the IPv4 address:
 - on the label sheet provided with the Com'X 510. This sheet can be stuck on the inside of the cover.
 - in the space provided in the **Ethernet configuration** collapsible menu in **Settings > General Settings > Network Settings** (See [Selecting a Network Configuration on page 31.](#))
4. Check that the IT manager has added the Com'X 510 to the DHCP server.

NOTE: It is also possible to log in by entering the IP address provided by the IT manager in the address bar of the browser.

This graphic shows the MAC address on the label of the Com'X 510:

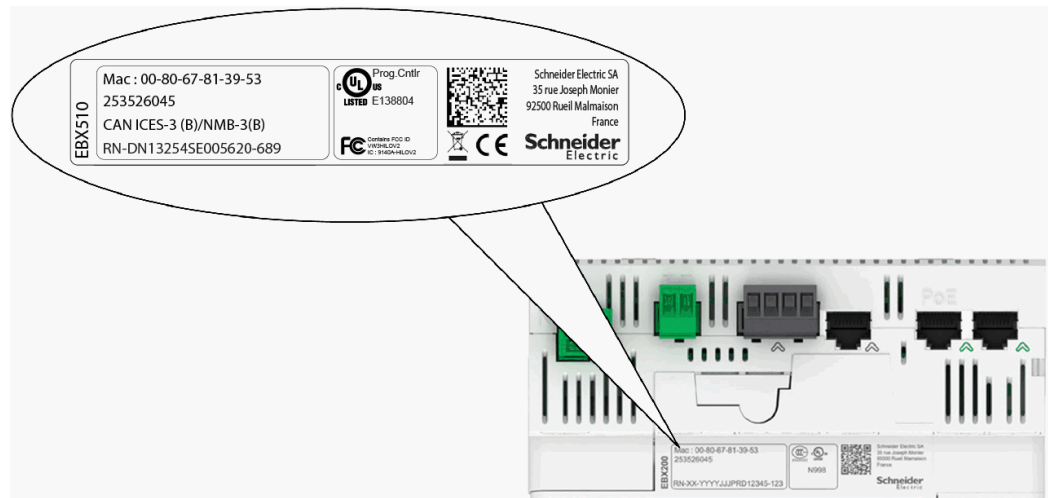

DHCP Server Over Ethernet Port

You can configure the Com'X 510 so that it assigns IP addresses to the network. In that case, the Com'X 510 configures its Ethernet interface **Eth2** with the IP address 10.25.1.1.

The Com'X 510 also starts an internal DHCP server. It enables you to assign automatically an IP address, consistent with its own address, to any devices connected to the same network and configured to operate as DHCP clients.

IP addresses assigned by the Com'X 510 are in the subnetwork 10.25.1.0/24 (starting from 10.25.1.65, 10.25.1.66, and so on). The Com'X 510 has no routing capabilities. As a result, no **Default Gateway** nor **Domain Name Server** are sent by this DHCP server.

The IT administrator of the site should be contacted to confirm that the network where the **Eth2** interface of the Com'X 510 is connected:

- is separated from the rest of the site network installation.
- does not disturb another DHCP server.

DHCP Server Over Wi-Fi

When a Wi-Fi key is connected to the Com'X 510, you can configure the Com'X 510 so that it creates a Wi-Fi access point.

In that case, the Com'X 510 creates a Wi-Fi network with an SSID using the same name as the Com'X 510 but without any access restriction (no WEP nor WPA authentication) in this mode. The Com'X 510 configures its Wi-Fi interface with the IP address 10.25.2.1.

The Com'X 510 also starts an internal DHCP server on this Wi-Fi interface. It enables you to assign automatically an IP address, consistent with its own address, to any Wi-Fi devices that are configured to operate as DHCP clients.

IP addresses assigned by the Com'X 510 are in the subnetwork 10.25.2.0/24 (starting from 10.25.2.65, 10.25.2.66, and so on). The Com'X 510 has no routing capabilities. As a result, no **Default Gateway** nor **Domain Name Server** are sent by this DHCP server.

Remote Access with Windows Operating Systems

You can remotely access the Com'X 510 by using an IP address under Windows XP. The IT administrator should be requested to provide a fixed IP address to assign systematically the same IP address to the Com'X 510.

With Windows 8, Windows 7, or Vista, the Com'X 510 is accessible under Windows Explorer (see [With Windows 7/Vista on page 18](#)) when connecting the PC to the same LAN. It is not necessary to know the IP address.

Appendix F: Modbus Register Mapping

Discovery Feature

The product responds to the Modbus function code FC43-14 with the following values:

- The `VendorName` = Schneider Electric
- The `ProductCode` = EBX510
- The `ProductName` = Com'X 510
- The `MajorMinorRevision` = the Com'X 510 version.

Com'X 510 Register Mapping

The following values can be read only through Modbus function codes FC03-FC04.

Address	Register	Object	Size (Word)	Format	Unit	Range	Comments
2399	2400	Digital Input Validity - Bit 0..5	1	Bitmap	–	0–0x003F	See note 1. Can be read with Modbus code FC01 (coil 38400 - 38405).
2400	2401	Digital Input - Bit 0..5	1	Bitmap	–	0–0x003F	See note 2. Can be read with Modbus code FC01 (coil 38416 - 38421).
8914	8915	Pulses count - DI1	2	INT32U	–	0–4G	See note 3.
8916	8917	Running hours - DI1	2	INT32U	sec	0–4G	See note 4.
8918	8919	Pulses count - DI2	2	INT32U	–	0–4G	See note 3.
8920	8921	Running hours - DI2	2	INT32U	sec	0–4G	See note 4.
8922	8923	Pulses count - DI3	2	INT32U	–	0–4G	See note 3.
8924	8925	Running hours - DI3	2	INT32U	sec	0–4G	See note 4.
8926	8927	Pulses count - DI4	2	INT32U	–	0–4G	See note 3.

8928	8929	Running hours - DI4	2	INT32U	sec	0-4G	See note 4.
8930	8931	Pulses count - DI5	2	INT32U	-	0-4G	See note 3.
8932	8933	Running hours - DI5	2	INT32U	sec	0-4G	See note 4.
8934	8935	Pulses count - DI6	2	INT32U	-	0-4G	See note 3.
8936	8937	Running hours - DI6	2	INT32U	sec	0-4G	See note 4.
8970	8971	Pulses count - DI1	2	FLOAT32	-	-	See note 3.
8972	8973	Pulses count flow - DI1	2	FLOAT32	1/sec	-	See note 3.
8974	8975	Pulses count - DI2	2	FLOAT32	-	-	See note 3.
8976	8977	Pulses count flow - DI2	2	FLOAT32	1/sec	-	See note 3.
8978	8979	Pulses count - DI3	2	FLOAT32	-	-	See note 3.
8980	8981	Pulses count flow - DI3	2	FLOAT32	1/sec	-	See note 3.
8982	8983	Pulses count - DI4	2	FLOAT32	-	-	See note 3.
8984	8985	Pulses count flow - DI4	2	FLOAT32	1/sec	-	See note 3.
8986	8987	Pulses count - DI5	2	FLOAT32	-	-	See note 3.
8988	8989	Pulses count flow - DI5	2	FLOAT32	1/sec	-	See note 3.
8990	8991	Pulses count - DI6	2	FLOAT32	-	-	See note 3.
8992	8993	Pulses count flow - DI6	2	FLOAT32	1/sec	-	See note 3.
9999	10000	Raw value - AI1	2	FLOAT32	(*)	-	See note 5.
10001	10002	Raw value - AI2	2	FLOAT32	(*)	-	See note 5.

1. One bit is set for each digital input (DI) used in the Com'X 510.
2. One bit is set for each digital input configured as a contactor or an impulse relay, if this device is closed.
3. This value is valid only if the digital input is configured as a pulse meter
4. This value is valid only if the digital input is configured as a contactor or an impulse relay
5. If the sensor connected to the analog input (AI)
 - is a PT100 or PT1000, the raw value is the sensor temperature.
 - is a 0-10V sensor, the raw value is the voltage value [0–10V].
 - is a 0-20mA sensor, the raw value is the current value [0–0.020A].

EM4300 Register Mapping

The following values can be read only through Modbus function codes FC03-FC04.

EM4300	EM4399	Address	Register	Description	Size	Data Type	Units	Update Frequency
X	X	1	2	Product Identifier (17150)	1	INT16U	–	<< 1 Minute
		2	3	Reserved	1998	–	–	–
X	X	2000	2001	Frequency	2	FLOAT32	Hz	1 Minute
X		2002	2003	Power Factor A	2	FLOAT32	–	1 Minute
X		2004	2005	Power Factor B	2	FLOAT32	–	1 Minute
X		2006	2007	Power Factor C	2	FLOAT32	–	1 Minute
X	X	2008	2009	Apparent Power A	2	FLOAT32	VA	1 Minute
X	X	2010	2011	Apparent Power B	2	FLOAT32	VA	1 Minute
X	X	2012	2013	Apparent Power C	2	FLOAT32	VA	1 Minute
X	X	2014	2015	Apparent Power	2	FLOAT32	VA	1 Minute
X		2016	2017	Reactive Power A	2	FLOAT32	VAR	1 Minute
X		2018	2019	Reactive Power B	2	FLOAT32	VAR	1 Minute
X		2020	2021	Reactive Power C	2	FLOAT32	VAR	1 Minute
X		2022	2023	Reactive Power	2	FLOAT32	VAR	1 Minute
X	X	2024	2025	Active Power A	2	FLOAT32	W	1 Minute
X	X	2026	2027	Active Power B	2	FLOAT32	W	1 Minute
X	X	2028	2029	Active Power C	2	FLOAT32	W	1 Minute
X	X	2030	2031	Active Power	2	FLOAT32	W	1 Minute

EM4300	EM4399	Address	Register	Description	Size	Data Type	Units	Update Frequency
X	X	2032	2033	Voltage A-N	2	FLOAT32	V	1 Minute
		2034	2035	Reserved	266	–	–	–
X	X	2100	2101	Max Current A over Dmd	2	FLOAT32	A	15 Minute
X	X	2102	2103	Max Current B over Dmd	2	FLOAT32	A	15 Minute
X	X	2104	2105	Max Current C over Dmd	2	FLOAT32	A	15 Minute
X	X	2106	2107	Min Voltage A-N over dmd	2	FLOAT32	V	15 Minute
X	X	2108	2109	Min Voltage B-N over dmd	2	FLOAT32	V	15 Minute
X	X	2110	2111	Min Voltage C-N over dmd	2	FLOAT32	V	15 Minute
		2113	2114	Reserved	187	–	–	–
X		2300	2301	Apparent energy delivered - received non-resettable	4	INT64	VAh	1 Minute
X		2304	2305	Apparent energy A delivered - received non-resettable	4	INT64	VAh	1 Minute
X		2308	2309	Apparent energy B delivered - received non-resettable	4	INT64	VAh	1 Minute
X		2312	2313	Apparent energy C delivered - received non-resettable	4	INT64	VAh	1 Minute
X		2316	2317	Reactive energy delivered - received non-resettable	4	INT64	VARh	1 Minute
X		2320	2321	Reactive energy A delivered - received non-resettable	4	INT64	VARh	1 Minute
X		2324	2325	Reactive energy B delivered - received non-resettable	4	INT64	VARh	1 Minute
X		2328	2329	Reactive energy C delivered - received non-resettable	4	INT64	VARh	1 Minute
X		2332	2333	Active energy delivered - received non-resettable	4	INT64	Wh	1 Minute
X		2336	2337	Active energy A delivered - received non-resettable	4	INT64	Wh	1 Minute
X		2340	2341	Active energy B delivered - received non-resettable	4	INT64	Wh	1 Minute
X		2344	2345	Active energy C delivered - received non-resettable	4	INT64	Wh	1 Minute
X		2348	2349	Apparent energy delivered - received	4	INT64	VAh	1 Minute

EM4300	EM4399	Address	Register	Description	Size	Data Type	Units	Update Frequency
X		2352	2353	Apparent energy A delivered - received	4	INT64	VAh	1 Minute
X		2356	2357	Apparent energy B delivered - received	4	INT64	VAh	1 Minute
X		2360	2361	Apparent energy C delivered - received	4	INT64	VAh	1 Minute
X		2364	2365	Reactive energy delivered - received	4	INT64	VARh	1 Minute
X		2368	2369	Reactive energy A delivered - received	4	INT64	VARh	1 Minute
X		2372	2373	Reactive energy B delivered - received	4	INT64	VARh	1 Minute
X		2376	2377	Reactive energy C delivered - received	4	INT64	VARh	1 Minute
X		2380	2381	Active energy delivered - received	4	INT64	Wh	1 Minute
X		2384	2385	Active energy A delivered - received	4	INT64	Wh	1 Minute
X		2388	2389	Active energy B delivered - received	4	INT64	Wh	1 Minute
X		2392	2393	Active energy C delivered - received	4	INT64	Wh	1 Minute
		2396	2397	Reserved	16	–	–	–
X	X	2412	2413	ZigBee link quality indicator (LQI)	1	INT16U	–	<< 1 Minute
X	X	2413	2414	ZigBee radio signal strength indicator (RSSI)	2	FLOAT32	dBm	<< 1 Minute
X	X	2415	2416	Zigbee packet error rate over last hour	2	FLOAT32	–	<< 1 Minute
X	X	2417	2418	ZigBee network extended network PAN ID 1	4	INT64U	–	<< 1 Minute
X	X	2421	2422	Zigbee radio output Power	2	FLOAT32	dBm	<< 1 Minute
		2423	2424	Reserved	77	–	–	–
	X	2500	2501	Apparent energy delivered + received non resettable	4	FLOAT32	VAh	1 Minute

EM4300	EM4399	Address	Register	Description	Size	Data Type	Units	Update Frequency
	X	2504	2505	Apparent Energy A Delivered + Received non resettable	4	FLOAT32	VAh	1 Minute
	X	2508	2509	Apparent Energy B Delivered + Received non resettable	4	FLOAT32	VAh	1 Minute
	X	2512	2513	Apparent Energy C Delivered + Received non resettable	4	FLOAT32	VAh	1 Minute
		2514	18	Reserved	16	–	–	–
	X	2532	2533	Active energy delivered + received non resettable	4	FLOAT32	Wh	1 Minute
	X	2536	2537	Active Energy A Delivered + Received non resettable	4	FLOAT32	Wh	1 Minute
	X	2540	2541	Active Energy B Delivered + Received non resettable	4	FLOAT32	Wh	1 Minute
	X	2544	2545	Active Energy C Delivered + Received non resettable	4	FLOAT32	Wh	1 Minute
	X	2548	2549	Apparent energy delivered + received	4	FLOAT32	VAh	1 Minute
	X	2552	2553	Apparent Energy A Delivered + Received	4	FLOAT32	VAh	1 Minute
	X	2556	2557	Apparent Energy B Delivered + Received	4	FLOAT32	VAh	1 Minute
	X	2560	2561	Apparent Energy C Delivered + Received	4	FLOAT32	VAh	1 Minute
		2562	18	Reserved	16	–	–	–
	X	2580	2581	Active energy delivered + received	4	FLOAT32	Wh	1 Minute
	X	2584	2585	Active Energy A Delivered + Received	4	FLOAT32	Wh	1 Minute
	X	2588	2588	Active Energy B Delivered + Received	4	FLOAT32	Wh	1 Minute
	X	2592	2593	Active Energy C Delivered + Received	4	FLOAT32	Wh	1 Minute

Index

A

- analog inputs
 - accessing through gateway 50
 - adding 78, 163
 - deleting 81
 - modifying 79
 - reconnecting 80
 - replacing 80
 - troubleshooting 149

C

- certificates 60
- Com'X
 - architecture 13
 - troubleshooting 152
 - user interface 22
- CSV export
 - exported data 81

D

- date and time
 - Com'X 29, 159
 - devices 107
- device discovery 164
- device IDs
 - local 52
 - local for Zigbee 91
 - slave 52
 - Zigbee 52
- digital inputs
 - accessing through gateway 50
 - adding 78, 161
 - deleting 81
 - modifying 79
 - reconnecting 80
 - replacing 80
 - troubleshooting 149
- Digital Service Platform 15
 - exported data 81
 - firmware upgrade 144
 - publication 47

E

- Energy Operation 156
 - exported data 81
 - publication 41, 166
 - publication ID 46
 - site information 49
- Ethernet
 - accessing through 18

- advanced settings 55
 - configuration 33
 - reboot cases 31
 - settings 32
 - switch mode 32
 - upstream/downstream 33

- Ethernet devices
 - adding 78
 - deleting 81
 - modifying 79
 - reconnecting 80
 - replacing 80

- events 65
 - creating 66
 - custom 65
 - deleting 68
 - editing 68
 - predefined 65

F

- firewall 59
- firmware
 - upgrading 143-144
- FTP 42

G

- GPRS
 - EBXA-GPRS 34, 37
 - EBXA-GPRS-SIM 34, 37
 - network 31
 - reboot cases 31
 - status 161
 - troubleshooting 152

H

- historical data
 - dashboards 102

L

- logging
 - intervals 50, 159
 - maintenance 137
 - starting/stopping 96
- login
 - multiple sessions 20

M

- main meter
 - adding custom 128
 - connecting custom 129
 - creating custom 125
 - measurement properties 126
 - signal properties 126

Modbus gateway 51
 TCP/IP filtering 53
Modbus serial devices
 adding 78, 87, 164
 custom 116
 deleting 81
 discovering 85
 modifying 79
 reconnecting 80
 replacing 80
 troubleshooting 150

P

password
 changing 21
 first login 21
 login 20
 session timeout 22
proxy 39
publication 159
 CSV 46
 DSP connection 47
 Energy Operation 159
 Ethernet 160
 FTP 42
 GPRS 161
 HTTP 43
 HTTPS 43
 publication ID 46
 SMTP 45
 starting 97
 transfer protocols 42
pulse meters 83

R

real time data
 device summary 100
 single device 99
resistance temperature detectors (RTD) 85
 measurement properties 85
 measurement table 85

S

switch mode 32

U

upstream/downstream mode 33
USB
 firmware upgrade 144
 restoring configuration 141
 saving configuration 140
 uploading configuration 142

W

web browser
 for PC 17
 for tablet 17
Wi-Fi
 access point settings 48
 accessing through 19
 activating 48
 deactivating 49
 troubleshooting 152

Z

ZigBee
 discovery 91
 Modbus registers 181
 network configuration 56

Com'X 510 Energy Server User Manual

Schneider Electric

35 rue Joseph Monier
92500 Rueil-Malmaison, France
www.schneider-electric.com

DOCA0098EN-05 10/2016
© 2016 Schneider Electric. All Rights Reserved.