

VOLTCRAFT

Dual-Channel Arbitrary Waveform Generator Quick Guide

- Item No.: 2616564 FG-1302
- Item No.: 2616563 FG-1602

Table of Contents

1. General Safety Requirement.....	1
2. Safety Terms and Symbols.....	1
3. General Inspection.....	2
4. Quick Start.....	3
Front panel overview	3
Rear Panel Overview	4
Power on	5
User Interface.....	5
Set the channel	6
Set basic waveform	7
Output the build-in waveform (including DC).....	8
Generate the Modulated Waveform.....	9
Generate Sweep.....	10
Generate Burst	10
Store.....	10
Communication with PC.....	10
Reading waveform	11
Write and Recall waveform	11
Utility Setting	13
Counter	13
Appendix A: Accessories	14
Appendix B: General Care and Cleaning	14

1. General Safety Requirement

Before any operations, please read the following safety precautions to avoid any possible bodily injury and prevent this product or any other products connected from damage. In order to avoid any contingent danger, this product is only used within the range specified.

Use Proper Power Cord. Use only the power cord supplied with the product and certified to use in your country.

Product Grounded. This instrument is grounded through the power cord grounding conductor. To avoid electric shock, the grounding conductor must be grounded. The product must be grounded properly before any connection with its input or output terminal.

Limit operation to the specified measurement category, voltage, or amperage ratings.

Check all Terminal Ratings. To avoid instrument damage and the risk of electric shock, check all the Measurement Limits and markers of this product. Refer to the user's manual for the Measurement Limits before connecting to the instrument. Do not exceed any of the Measurement Limits defined in the following section.

Do not operate without covers. Do not operate the instrument with covers or panels removed.

Use Proper Fuse. Use only the specified type and rating fuse for this instrument.

Avoid exposed circuit. Do not touch exposed junctions and components when the instrument is powered.

Do not operate if in any doubt. If you suspect damage occurs to the instrument, have it inspected by qualified service personnel before further operations.

Use your instrument in a well-ventilated area. Inadequate ventilation may cause increasing of temperature or damages to the device. Please keep well ventilated and inspect the intake regularly.

Do not operate in wet conditions. In order to avoid short circuiting to the interior of the device or electric shock, please do not operate in a humid environment.

Do not operate in an explosive atmosphere.

Keep product surfaces clean and dry.

Only the qualified technicians can implement the maintenance.

2. Safety Terms and Symbols

Terms in this Manual. The following terms may appear in this manual:

Warning: Warning indicates the conditions or practices that could result in injury or loss of life.

Caution: Caution indicates the conditions or practices that could result in damage to this product or other property.

Terms on the Product. The following terms may appear on this product:

Danger: It indicates an injury or hazard may immediately happen.

Warning: It indicates an injury or hazard may be accessible potentially.

Caution: It indicates a potential damage to the instrument or other property might occur.

Safety Symbols

Symbols on the Product. The following symbol may appear on the product:



Hazardous Voltage



Refer to Manual



Protective Earth Terminal



Chassis Ground



Test Ground

3. General Inspection

After you get a new device, it is recommended that you should make a check on the instrument according to the following steps:

1. Check whether there is any damage caused by transportation.

If it is found that the packaging carton or the foamed plastic protection cushion has suffered serious damage, do not throw it away first till the complete device and its accessories succeed in the electrical and mechanical property tests.

2. Check the Accessories

The supplied accessories have been already described in Appendix A: Accessories of this manual. You can check whether there is any loss of accessories with reference to this description. If it is found that there is any accessory lost or damaged, please get in touch with our distributor responsible for this service or our local offices.

3. Check the Complete Instrument

If it is found that there is damage to the appearance of the instrument, or the instrument can not work normally, or fails in the performance test, please get in touch with our distributor responsible for this business or our local offices. If there is damage to the instrument caused by the transportation, please keep the package. With the transportation department or our distributor responsible for this business informed about it, a repairing or replacement of the instrument will be arranged by us.

4. Quick Start

Front panel overview

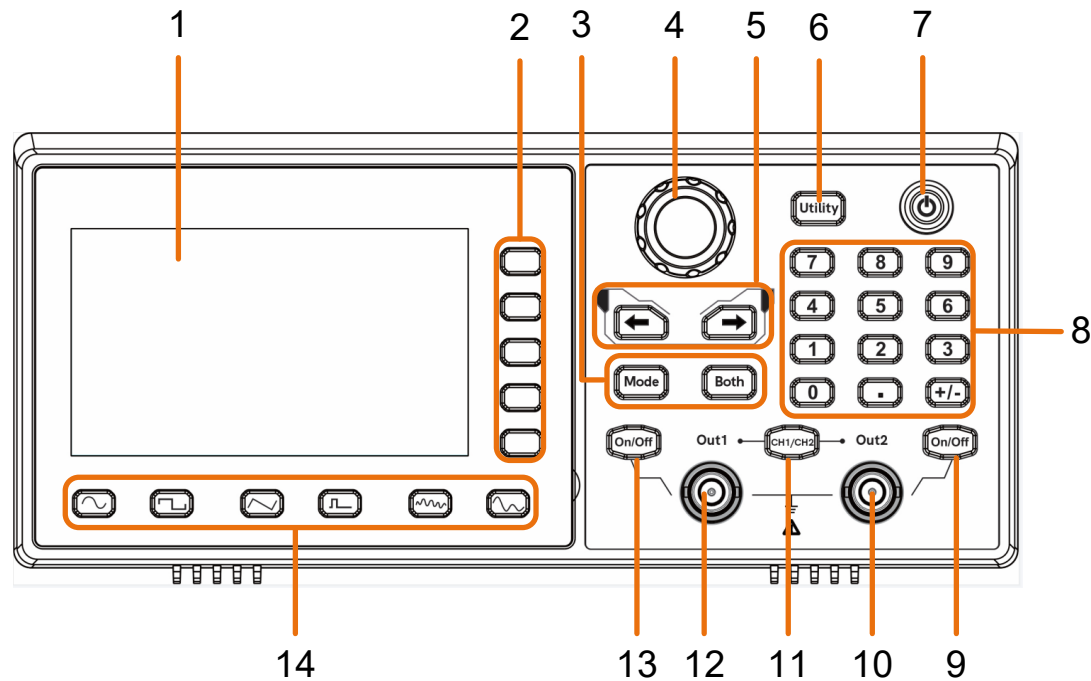







Figure 4-1 Front Panel overview

1	LCD	Display the user interface
2	Menu selection keys	Includes 5 keys to activate the corresponding menu
3	Mode keys	Mode: output the modulated waveform Both: Display the editable parameters of both channels
4	Knob	Change the currently selected value, also used to select the arbitrary waveform types and ard data file name. When in the sweep manual mode, press this knob to trigger manually
5	Direction key	Move the cursor of the selected parameter
6	Operation keys	Utility: set the utility function
7	Power button	Turn on/off the waveform generator.

8	Number keypad	Input the parameter
9	On/Off button	Turns the output of the CH2 channel on or off. When the output is turned on, the backlight of the button lights up
10	Out 2	Output CH2 signal
11	CH1/CH2	Switch channel displayed on the screen between CH1 and CH2
12	Out 1	Output CH1 signal
13	On/Off button	Turns the output of the CH1 channel on or off. When the output is turned on, the backlight of the button lights up
14	Waveform Selection area	Includes: Sine  , Square  , Ramp  , Pulse  , Noise  , Arb Wave  .

Rear Panel Overview

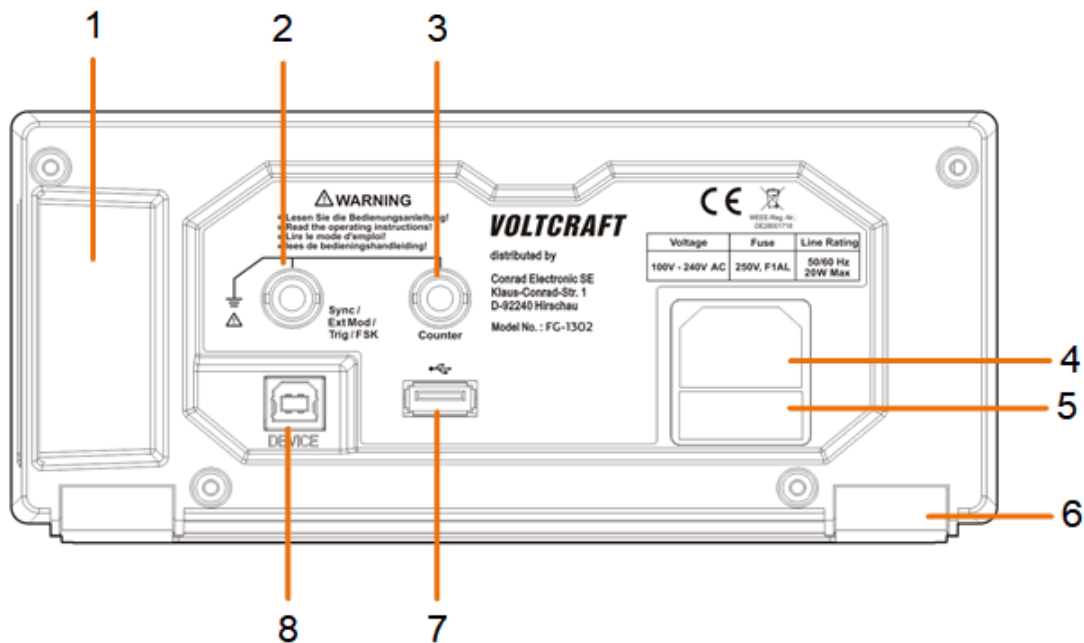

Figure 4-2 Rear Panel Overview

1	Handle	
2	Signal connector	Used to connect the input or output of a functional signal
3	Counter input	Used to receive the frequency meter input signal

4	AC input connector	AC input connector
5	Fuse Container	The place to install the fuse
6	Foot Stool	Tilt the signal generator for easy operation
7	USB interface	Connect with external USB devices, e.g. USB stick
8	USB Device interface	Used to connect a USB type B controller. Can be connected with PC, the signal generator can be controlled by the host computer software

Power on

- (1) Connect the instrument to an DC power source using the power cord supplied with the accessory.



Warning:

To prevent electric shock, make sure the instrument is properly grounded.

- (2) Press the **power button** on the front panel. The back of the power channel switch will light up, and the buzzer will sound.

User Interface

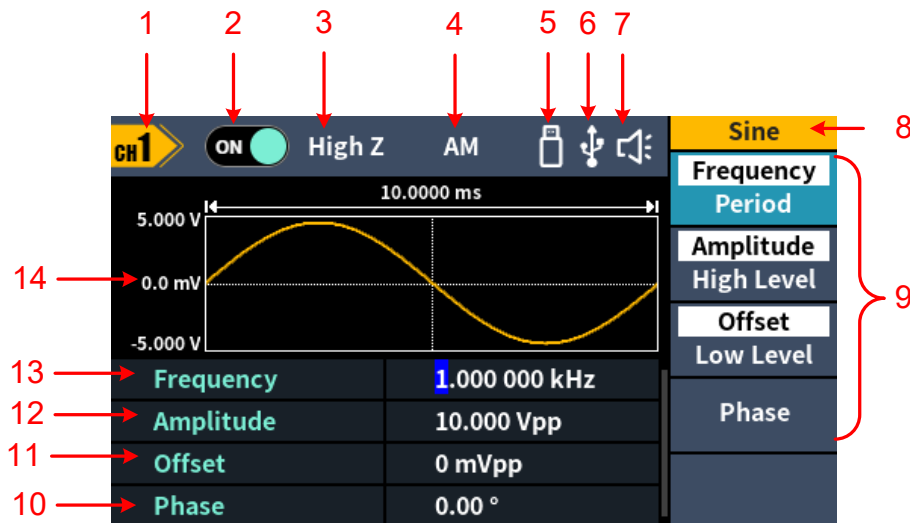

Figure 4-3 User Interface

1	Display channel name
2	Display channel switch status
3	Display load
4	Current mode

5	When the instrument detects the USB flash drive, it lights up
6	Lights up the indicator when connected to the USB Host via the USB DEVICE interface
7	Buzzer
8	Menu title
9	Current waveform or mode setting menu
10	Start phase
11	Offset / low level, depending on the right highlighted menu
12	Amplitude / high level, depending on the right highlighted menu item
13	Frequency/Period, depending on the highlighted menu item
14	Display current waveform

Set the channel

- **Select the channel for configuration**

Before configuring waveform parameters, you must first select the channel you want to configure. Press **CH1 /CH2** to switch to the desired channel and the user interface.

- **To Display/Edit Both Channels**

Press **Both** button to display the parameters of both channels.

To switch channel: Press **CH1/2** to switch the editable channel.

To select waveform: Press **Waveform selection buttons** to select waveform of current channel.

To select parameter: Press **Menu selection keys** to choose the **Parameter 1** to **Parameter 4 (Corresponding keys 2-4)**; Press it again to switch the current parameter such as Frequency/Period.



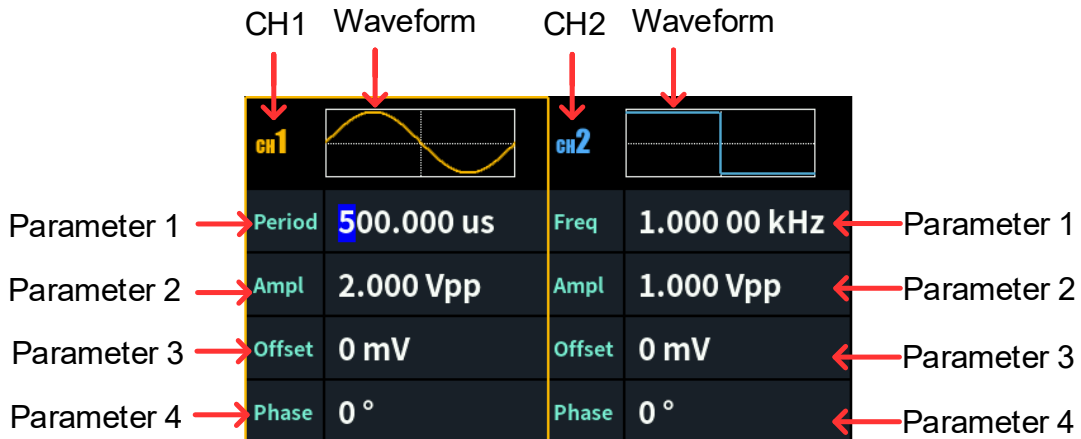



To edit parameter: Turn the **knob** to change the value of cursor position. Press **←/→** direction key to move the cursor. (The number keys can not be used to input.)



- **Turn on/off channel output**

Press CH1 **On/Off** or CH2 **On/Off** on the front panel to turn on/off the corresponding channel output. The channel will light up when it is set to output.

Set basic waveform

Can set and output the Sine, Square, Ramp, Pulse, Noise or Arbitrary waveform. Press the waveform selection button on the front panel of the instrument: sine , square , ramp , pulse , noise , arbitrary , and enter the corresponding waveform setting interface. The waveform is different and the parameters that can be set are different.

Example: Press the  key and press the Frequency/Period soft key. The selected menu item is highlighted on white, and the cursor will display on corresponding parameter item in the user interface. Press the Frequency/Period softkey to switch the frequency/period.

There are two ways to change the selected parameter value:

- Turn the **Knob** to increase or decrease the value at the cursor. Press the direction keys to move the cursor left or right.
- Press a **number key** on the numeric keypad directly, the screen will pop out of the data input box, continue to input the desired value. Press the right menu soft key to select the unit of the parameter. Press the **Back** softkey to cancel the current entry.

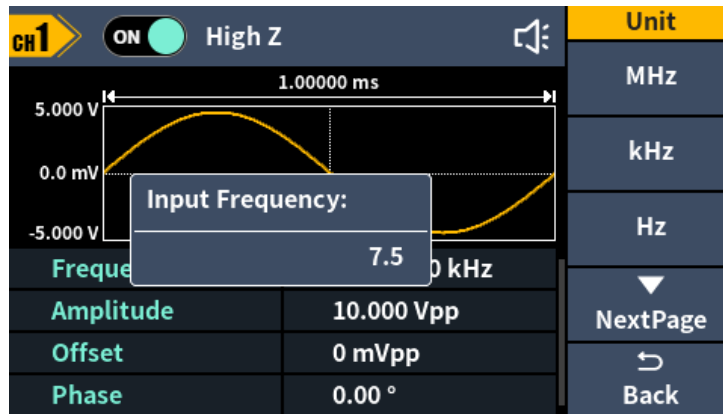



Figure 4-4: Use numeric keypad to set the frequency

Parameters of waveforms

Waveform	Menu Items
Sine	Frequency/Period, Amplitude/High Level, Offset/Low Level, Phase
Square	Frequency/Period, Amplitude/High Level, Offset/Low Level, Phase
Ramp	Frequency/Period, Amplitude/High Level, Offset/Low Level, Phase Symmetry
Pulse	Frequency/Period, Amplitude/ High Level, Offset/Low Level, Phase, Width/Duty, Rise,Fall
Noise	Amplitude/High Level, Offset/Low Level
Arbitrary	Frequency/Period, Amplitude/High Level, Offset/Low Level, Phase, Bult-in,Store

Output the build-in waveform (including DC)

- (1) Press the  arbitrary wave button, then press the **NextPage** ,to the nextpage menu.
- (2) Press the **Built-in** softkey,go to the build-in waveform and select the menu。
- (3) Press the **Common**, **Medical treatment**, **Standard** softkeys to select the build-in waveform mode:
 Press the **NextPage** softkeys, to select the build-in waveform: **Maths**, **Trigonometric**, **Window function**.
 Press the **NextPage** softkeys, to select the build-in waveform: **Engineering**, **Seg Mod**, **Fan test**.

Note: DC is a type of built-in waveform, located in the "Common" category, named "DC".

Generate the Modulated Waveform

Supported modulation types include: AM (Amplitude Modulation), FM (Frequency Modulation), PM (Phase Modulation), PWM (Pulse Width Modulation), ASK (Amplitude Shift Keying), PSK (Phase Shift Keying), FSK (Frequency Shift Keying), 3FSK (Ternary Frequency Shift Keying), 4FSK (Quadrature Frequency Shift Keying), BPSK (Biphase Phase Shift Keying), QPSK (Quadrature Phase Shift Keying), OSK (Oscillating Keying), SUM (Sum Modulation), DSB-AM (Double-Sideband Amplitude Modulation) , Sweep and Brust.

Press the **Mode** function key, to select the modulation type enter the setup menu. To turn off the modulation, press the **Mode** function button again.

Parameters of modulated waveforms:

Type	Parameters	
AM	Internal source	Shape, AM Frequency, Depth
	External source	None
FM	Internal source	Shape, FM Frequency, Deviation
	External source	Deviation
PM	Internal source	Shape, PM Frequency, Phase Deviation
	External source	Phase Deviation
PWM	Internal source	Shape, PWM Frequency, Duty Deviation
	External source	Duty Deviation
ASK	Internal source	ASK Rate, Amplitude
	External source	Amplitude
PSK	Internal source	PSK Rate, Phase Deviation
	External source	Phase Deviation
FSK	Internal source	FSK Rate, Hop Frequency
	External source	Hop Frequency
3FSK	FSK Rate, Hop Frequency 1, Hop Frequency 2	
4FSK	FSK Rate, Hop Frequency 1, Hop Frequency 2, Hop Frequency 3	
BPSK	Rate, Deviation, Data Source	
QPSK	Rate,Phase1, Phase2, Phase3	
OSK	Internal source	OSK Frequency,Oscillating Time
SUM	Internal source	Shape, AM Frequency, Depth
	External source	None
DSB_AM	Internal source	Shape, DSB_AM Frequency, Depth
	External source	None
Sweep	Internal source	Linear/Log, Sweep Time, Start Freq/Center
	External source	
	Manual source	Freq, Stop Freq/Freq Span
Burst	Internal source	Burst Period,N_Cycle/Gated,Cycles/Infinite
	External source	N_Cycle/Gated,Cycles/Infinite

Generate Sweep

In the frequency sweep mode, the generator "steps" from the start frequency to the stop frequency at the sweep rate you specify. Sweep can be generated by Sine, Square, Ramp or Arbitrary waveforms.

When the output signal is Sine, Square, Ramp or Arbitrary waveform, press the front panel **Mode** key ,then press the **Sweep** to enter the sweep mode. The parameters allowed to be set are: Sweep Time, Linear/Log, Start Frequency/Center Frequency, Stop Frequency/Frequency Span, Source.

Generate Burst

Press the **Mode** function key, then press the **Burst** enter burst mode, to generate versatile waveforms in burst.Burst can last for certain times of waveform cycle (N-Cycle Burst). Bust can apply to Sine, Square, Ramp, Pulse and Arbitrary waveforms.The parameters allowed to be set are: Burst Period, Cycles/Infinite and Trigger source.

Store

Supports communication with a computer via a USB port. Using the Waveform Editor software installed on the computer, the signal generator can be operated on the computer to control the output and write of the signal generator.

The instrument settings can be saved as files in internal memory. Up to 16 instrument settings can be saved in the instrument internal memory.

Note: Please go to our official website to obtain the Waveform Edito communication software and install it.

Communication with PC

- (1) **Set the USB device protocol type of the signal generator:** Press **Utility** → System → USBDev, switch to PC.
- (2) **Connection:** Connect the USB Device interface on the rear panel of the signal generator to the **USB interface** of the computer with a USB cable.
- (3) **Install the driver:** Run Waveform Editor software on the computer. Follow the instructions to install the driver. The path of the driver is the USBDRV folder in the directory where the Waveform Editor communication software is located, such as "C:\Program Files (x86)\DS_Wave\Waveform

Editor\USBDRV".

- (4) **Host computer communication port setting:** Open the Waveform Editor software, click "Communications" in the menu bar, select "Ports-Settings", in the setting dialog box, select the communication port as "USB". After the connection is successful, the connection status prompt in the lower right corner of the software interface turns green.

Reading waveform

- (1) Please visit our official website to obtain the installation package and decompress it.
- (2) Double click "Waveform Editor.exe" icon to run the software.

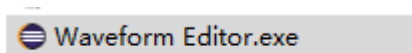

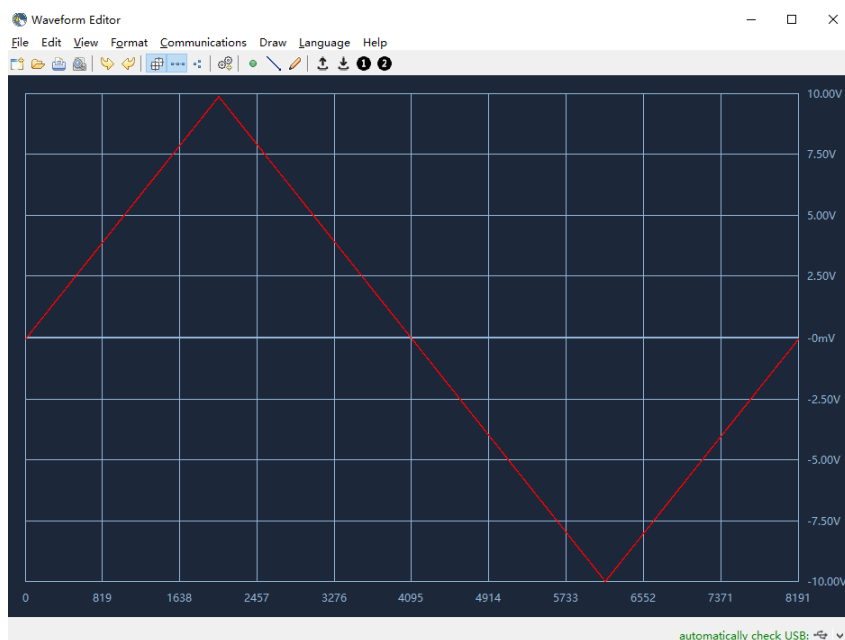

- (3) Enter the "Waveform Editor" interface.
- (4) Select the required waveform on the instrument.
- (5) Under Waveform Editor software interface, click "Read Waveform Icon"  " button, and the waveform will be read and displayed on the screen.



Write and Recall waveform

We can use the Line Draw, Hand Draw and Point Edit mode in the Waveform Editor to edit the required waveform, and save and display it on the instrument by writing.

- (1) Under Waveform Editor software interface, Click "Write waveform Icon  " button.
 - (2) After the writing is successful, the "File transfer completed" prompt box will be displayed in the waveform editor. Click "OK".
 - (3) On the instrument, the screen shows "Any wave has been updated to USERX(X is 0-15)".
 - (4) Press the  Arb Wave button ,then press the **NextPage** button to enter the nextpage menu.
 - (5) Press the **Store** soft key to enter the file system, and then press the **Enter** soft key to enter the file system. Select the file name "USERX" that has just written the waveform.
 - (6) Press the **Call out** soft key, the screen displays "File read successfully", then press the  arbitrary wave key, the written waveform can be viewed on the instrument.
- Note:** The file size is displayed on the right of the file. If 0B is displayed, the file is empty.

Utility Setting

Press the front panel **Utility** function key to enter the system options menu. The user can set the display parameters of the signal generator, CH1/2 parameters, interface parameters and system parameters. Press **Utility** again to exit the system options menu.

Utility system menu

Menu	Description
Display Setting	
Backlight	Set the parameter value of the screen brightness
Screen saver	Set the On/Off screen saver; If set to ON, the screen saver time range can be 1 to 999 minutes
Separator	Set the separator for the screen display data
CH1/2 Setting	
CH1 Load	It is convenient for the user to match the display voltage with the desired load. The range is from 1 Ω to 10 k Ω
CH2 Load	
Sync	Enable/disable sync output terminal to output sync signal
Align Phase	Set the phase of the output signals of the two channels to be consistent
System Setting	
Language	Only English supported.
Beeper	If On, it makes sounds when prompted
USB Device	Set the communication protocol type of the USB Device interface on the rear panel. PC: This is the internal communication protocol. Select this option when connecting to the Waveform Editor software running on computer via the USB Device interface. USBTMC: Select this when you need to use the USBTMC communication protocol standard.
Factory Set	Factory restoration
Upgrade	The instrument firmware can be updated using a USB storage device through the rear panel USB interface.
Counter Setting	
HF Rejection	Enable/disable high frequency rejection.

Counter

The frequency counter measures signals in the frequency range from 100 MHz to 200 MHz. The **[Counter]** connector on the rear panel is used by default to receive the frequency counter input signal. The frequency meter works from

the start.

- (1) Press the **Utility** function key ,then press the **Counter** to enter the frequency counter interface.
- (2) Connect the signal to be tested to the **[Counter]** connector on the rear panel.
- (3) Press the HFR softkey to toggle On or Off high frequency rejection. High-frequency rejection can be used to filter high-frequency factors when measuring low-frequency signals, improving measurement accuracy. When measuring low frequency signals with a frequency less than 1 kHz, turn on high frequency rejection to filter out high frequency noise interference; turn off high frequency rejection when measuring high frequency signals with frequencies greater than 1 kHz.
- (4) The frequency, period and duty cycle can be viewed on the frequency meter interface. Appendix

Appendix A: Accessories

- 1 × power cord that meets the standards of the country where you are located
- 1 × USB communication cable
- 1 × BNC/Q9 cable
- 1 × BNC to alligator cable
- 1 × extra fuse
- 1 × EN Quick Guide
- 1 × DE Quick Guide
- 1 × safety hintsheet
- 1 × CD ROM

Appendix B: General Care and Cleaning

General Maintenance

Do not store or leave the instrument where the liquid crystal display will be exposed to direct sunlight for long periods of time.

Caution: To avoid any damage to the instrument or probe, do not exposed it to any sprays, liquids, or solvents.

Cleaning

Inspect the instrument and probes as often as operating conditions require. To clean the instrument exterior, perform the following steps:

1. Wipe the dust from the instrument and probe surface with a soft cloth. Do not make any scuffing on the transparent LCD protection screen when clean the LCD screen.

4.Quick Start

2. Disconnect power before cleaning your instrument. Clean the instrument with a wet soft cloth not dripping water. It is recommended to scrub with soft detergent or fresh water. To avoid damage to the instrument or probe, do not use any corrosive chemical cleaning agent



Warning: Before power on again for operation, it is required to confirm that the instrument has already been dried completely, avoiding any electrical short circuit or bodily injury resulting from the moisture.

2022.12 V1.0.0

VOLTCRAFT

Dual-Channel Arbitrary Waveform Generator User Manual

- **Item No.: 2616564 FG-1302**
- **Item No.: 2616563 FG-1602**

Table of Contents

1.General Safety Requirement.....	1
2.Safety Terms and Symbols	1
3.General Inspection.....	1
4.Quick Start.....	2
Front Panel Overview	2
Rear Panel Overview	3
Power On.....	4
User Interface.....	4
5.Panel Operation	5
Channel Setting.....	5
Select the channel for configuration	5
To Display/Edit Both Channels.....	5
Turn on/off channel output	6
Waveform Setting.....	6
Output Sine Wave	6
Set the frequency/period	7
Set the amplitude.....	8
Set the offset	8
Set the high level	8
Set the low level.....	8
Set the Phase.....	9
Output Square Wave.....	9
Output Ramp Wave.....	9
Set the symmetry.....	10
Output Pulse Wave	11
Set the pulse width/duty cycle	11
Set the rising time.....	12
Set the falling time.....	12
Output Noise Wave	14
Output Arbitrary Wave.....	14
Select build-in wave (including DC).....	15
Store	20
Generate Sweep (Sweep)	22
Generate Burst (Burst)	23
Set N-Cycle Burst.....	24
Set Gated Burst.....	25
Output the Modulated Waves	26

AM (Amplitude Modulation).....	27
DSBAM (Double Sideband AM)	28
FM (Frequency Modulation).....	30
PM (Phase Modulation).....	31
PWM (Pulse Width Modulation)	32
ASK (Amplitude Shift Keying).....	34
PSK (Phase Shift Keying)	35
FSK (Frequency Shift Keying).....	36
3FSK (3 Frequency Shift Keying)	37
4FSK (4 Frequency Shift Keying)	39
BPSK (Binary Phase Shift Keying)	40
OSK (Oscillation Shift Keying).....	42
SUM (Sum Modulation)	43
Utility Function Setting	45
Display Settings.....	45
Brightness Control.....	45
Screen Saver	45
Separator	45
CH1/2 Settings.....	46
Load.....	46
Sync.....	46
System Settings.....	47
Language.....	47
Beeper	47
USB Device Type	48
Restore to the factory setting.....	48
Firmware Update	51
Counter	52
6.Communication with PC.....	53
7.Troubleshooting.....	53
8.Specification	54
Waveforms.....	54
Frequency Characteristics	54
Amplitude Characteristics	55
Signal Characteristics	55
Modulation Characteristics.....	56
Sweep Characteristics	59
Burst Characteristics.....	60
Counter Specifications.....	60
Input/Output Characteristics	60
General Specifications.....	60

9.Appendix	62
Appendix A: Accessories	62
Appendix B: General Care and Cleaning	62

1. General Safety Requirement

Before any operations, please read the following safety precautions to avoid any possible bodily injury and prevent this product or any other products connected from damage. In order to avoid any contingent danger, this product is only used within the range specified.

Only the qualified technicians can implement the maintenance.

To avoid Fire or Personal Injury:

Use Proper Power Cord. Use only the power cord supplied with the product and certified to use in your country.

Product Grounded. This instrument is grounded through the power cord grounding conductor. To avoid electric shock, the grounding conductor must be grounded. The product must be grounded properly before any connection with its input or output terminal.

Limit operation to the specified measurement category, voltage, or amperage ratings.

Check all Terminal Ratings. To avoid fire or shock hazard, check all ratings and markers on the instrument. Refer to the user's manual for more information about ratings before connecting the instrument. Do not exceed any of ratings defined in the following section.

Do not operate without covers. Do not operate the instrument with covers or panels removed.

Use Proper Fuse. Use only the specified type and rating fuse for this instrument.

Avoid exposed circuit. Do not touch exposed junctions and components when the instrument is powered.

Do not operate if in any doubt. If you suspect damage occurs to the instrument, have it inspected by qualified service personnel before further operations.

Use your instrument in a well-ventilated area. Inadequate ventilation may cause an increasing of temperature or damages to the instrument. Please keep the instrument well ventilated, and inspect the air outlet and the fan regularly.

Do not operate in wet conditions. To avoid short circuit inside the instrument or electric shock, never operate the instrument in a humid environment.

Do not operate in an explosive atmosphere.

Keep instrument surfaces clean and dry.

2. Safety Terms and Symbols

Safety Terms

Terms in this Manual. The following terms may appear in this manual:



Warning: Warning indicates the conditions or practices that could result in injury or loss of life.



Caution: Caution indicates the conditions or practices that could result in damage to this product or other property.

Terms on the Product. The following terms may appear on this product:

Danger: It indicates an injury or hazard may immediately happen.

Warning: It indicates an injury or hazard may be accessible potentially.

Caution: It indicates a potential damage to the instrument or other property might occur.

Safety Symbols

Symbols on the Product. The following symbol may appear on the product:



Hazardous Voltage



Refer to Manual



Protective Earth Terminal



Chassis Ground



Test Ground

3. General Inspection

After you get a new device, it is recommended that you should make a check on the instrument according to the following steps:

1. Check whether there is any damage caused by transportation.

If it is found that the packaging carton or the foamed plastic protection cushion has suffered serious damage, do not throw it away first till the complete device and its accessories succeed in the electrical and mechanical property tests.

2. Check the Accessories

The supplied accessories have been already described in *Appendix A: Accessories* of this manual. You can check whether there is any loss of accessories with reference to this description. If it is found that there is any accessory lost or damaged, please get in touch with our distributor responsible for this service or our local offices.

3. Check the Complete Instrument

If it is found that there is damage to the appearance of the instrument, or the instrument can not work normally, or fails in the performance test, please get in touch with our distributor responsible for this business or our local offices. If there is damage to the instrument caused by the transportation, please keep the package. With the transportation department or our distributor responsible for this business informed about it, a repairing or replacement of the instrument will be arranged by us.

4. Quick Start

Front Panel Overview

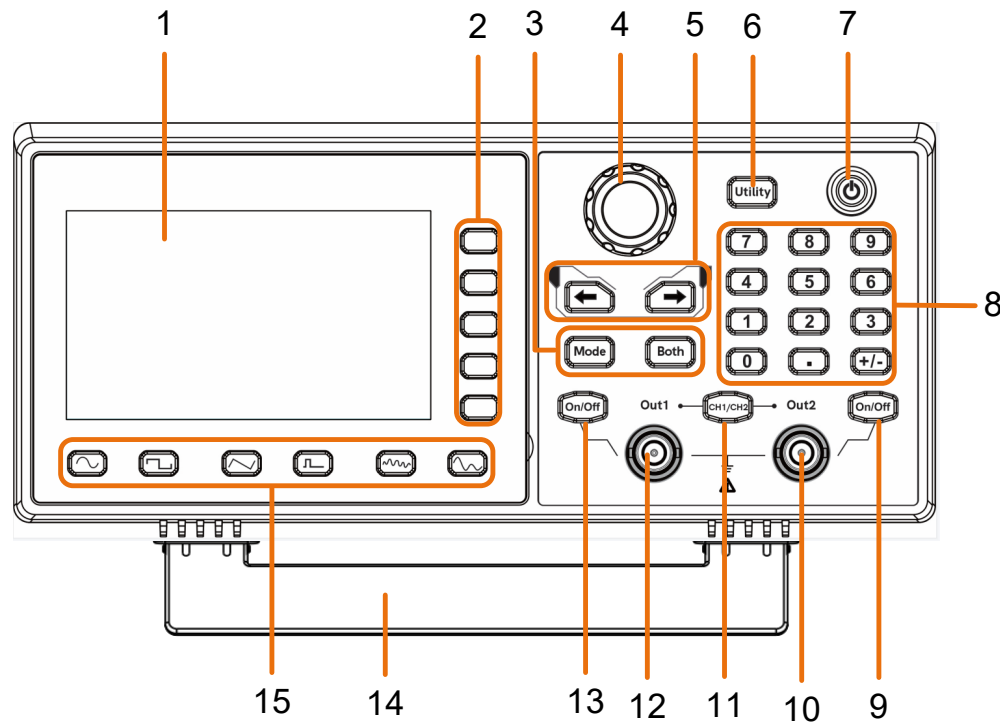







Figure 4-1: Front Panel overview

1	LCD	Display the user interface
2	Menu selection keys	Includes 5 keys to activate the corresponding menu
3	Operation keys	Mode: output the modulated waveform Both: Display the editable parameters of both channels.
4	Knob	Change the currently selected value, also used to select the arbitrary waveform types and arb data file name. When in the sweep or burst manual modes, press this knob to trigger manually.
5	Direction key	Move the cursor of the selected parameter
6	Operation key(Utility)	set the utility function
7	Power button	Turn on/off the waveform generator.
8	Number	Input the parameter

keypad	
9	On/Off button Turns the output of the CH2 channel on or off. When the output is turned on, the backlight of the button lights up.
10	Out 2 Output CH2 signal
11	CH1/CH2 Switch channel displayed on the screen between CH1 and CH2
12	Out 1 Output CH1 signal
13	On/Off button Turns the output of the CH1 channel on or off. When the output is turned on, the backlight of the button lights up
14	Foot Stool Tilt the signal generator for easy operation
15	Waveform Selection area Includes: Sine  , Square  , Ramp  , Pulse  , Noise  , Arb Wave  .

Rear Panel Overview

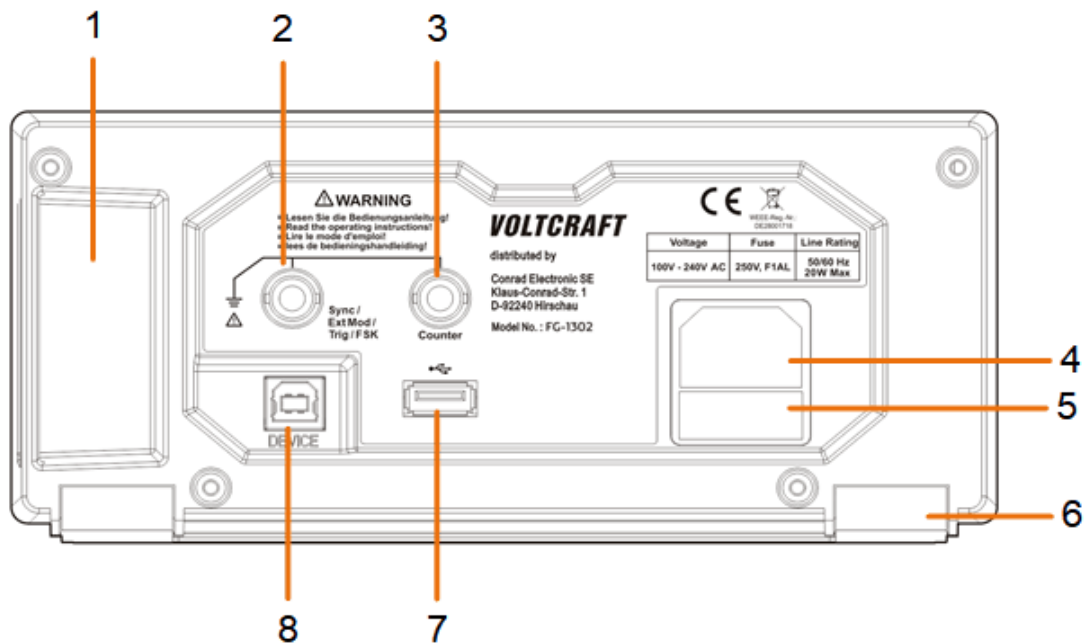

Figure 4-2: Rear Panel Overview

1	Handle	
2	Signal connector	Used to connect the input or output of a functional signal
3	Counter input	Used to receive the frequency meter input signal

4	AC input connector	AC input connector
5	Fuse Container	The place to install the fuse
6	Foot Pad	Tilt the signal generator for easy operation
7	USB interface	Connect with external USB devices, e.g. USB stick
8	USB Device interface	Used to connect a USB type B controller. Can be connected with PC, the signal generator can be controlled by the host computer software

Power On

- (1) Connect the instrument to an AC power source using the power cord supplied with the accessory.



Warning:

To prevent electric shock, make sure the instrument is properly grounded.

- (2) Press the **power button** on the front panel. The backlight of the power channel switch will light up, and the buzzer will sound.

User Interface

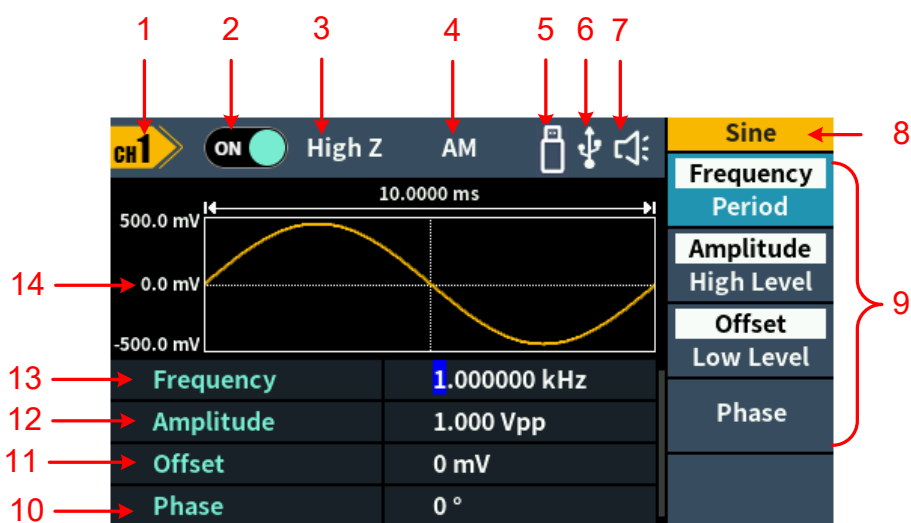

Figure 4-3: User Interface

- 1 Display channel name

2	Display channel switch status
3	Display load
4	Current mode
5	When the instrument detects the USB flash drive, it lights up
6	Lights up the indicator when connected to the USB Host via the USB DEVICE interface
7	Buzzer
8	Menu title
9	Current waveform or mode setting menu
10	Start phase
11	Offset / low level, depending on the right highlighted menu
12	Amplitude / high level, depending on the right highlighted menu item
13	Frequency/Period, depending on the highlighted menu item
14	Display current waveform

5. Panel Operation

Channel Setting

Select the channel for configuration

Before configuring waveform parameters, you must first select the channel you want to configure. Press **CH1 /CH2** to switch to the desired channel, and the user interface displays channel information.

To Display/Edit Both Channels

Press **Both** button to display the parameters of both channels.

To switch channel: Press **CH1/CH2** to switch the editable channel.

To select waveform: Press 、、、、、, to select waveform of current channel.

To select parameter: Press **Menu selection keys** to choose the **Parameter 1** to **Parameter 4** (**Corresponding keys 2-5**) ; Press it again to switch the current parameter such as Frequency/Period.

To edit parameter: Turn the **knob** to change the value of cursor position. Press **←/→** direction key to move the cursor. (The number keys can not be used to input.)

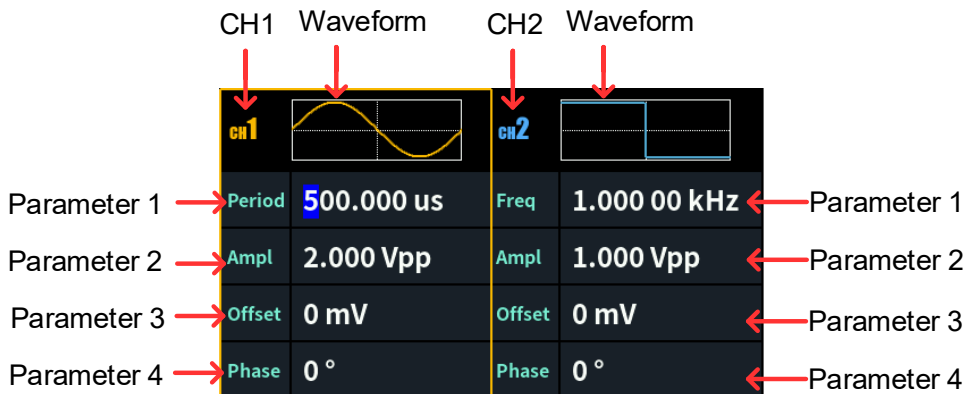







Figure 5-1: The User Interface of **(Both)** button

Turn on/off channel output

Press CH1 **On/Off** or CH2 **On/Off** on the front panel to turn on/off the corresponding channel output. The channel will light up when it is set to output.

Waveform Setting

Sine, square, ramp, pulse, noise or arbitrary waves can be set and output. Press the waveform selection button on the front panel: sine , square , ramp , pulse , noise , arbitrary wave , and enter the corresponding waveform setting interface. The waveform is different and the parameters that can be set are different.

Note: The following setting waveform uses CH1 channel as an example. If you need to set CH2 channel, please refer to CH1 channel specific operation.

Output Sine Wave

Press , the screen displays the user interface of the sine wave. The Sine waveform parameters can be set by operating the Sine setting menu on the right.

The sine wave menu includes: **Frequency/Period, Amplitude/High Level,**

Offset/Low Level and **Phase**. The menu can be operated by the menu selection button on the right.

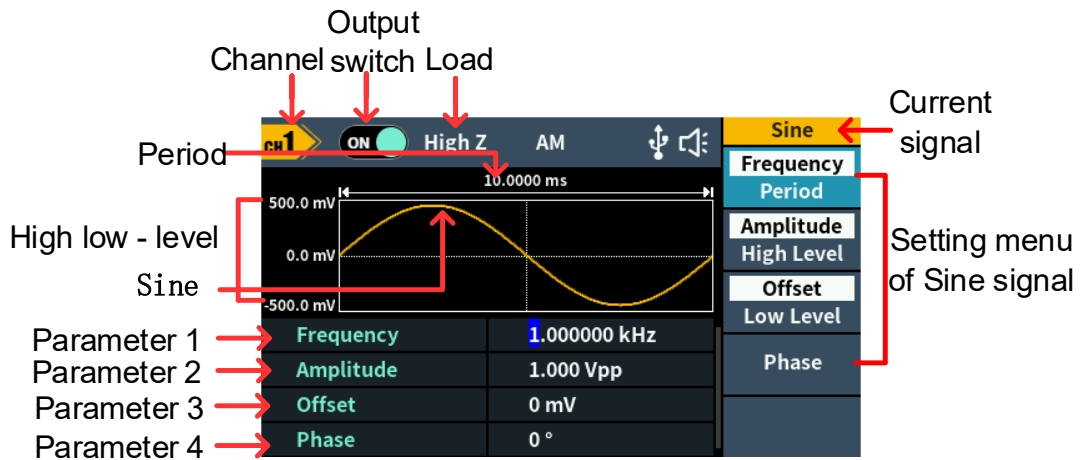

Figure 5-2: Sine wave user interface

Set the frequency/period

- Press **CH1/CH2**, Select Display **CH1** channel.
- Press the On/Off button on the CH1, enable channel CH1.
- Press the **Frequency/Period** softkey, the selected menu item is highlighted in white, and a cursor will display on the corresponding parameter item in **Parameter 1**. Press the **Frequency/Period** softkey to switch the frequency and period.

There are two ways to change the selected parameter value:

- Turn the **knob** to increase or decrease the value at the cursor. Press the **←/→** arrow key to move the cursor left or right.
- Press a number key on the **numeric keypad** directly, the screen will pop out the data input box, input the desired value. Press the **MHz, kHz, Hz, mHz, uHz** softkeys to select the unit of the parameter, confirm numeric input. Press the **Back** softkey to cancel the current input parameter value.

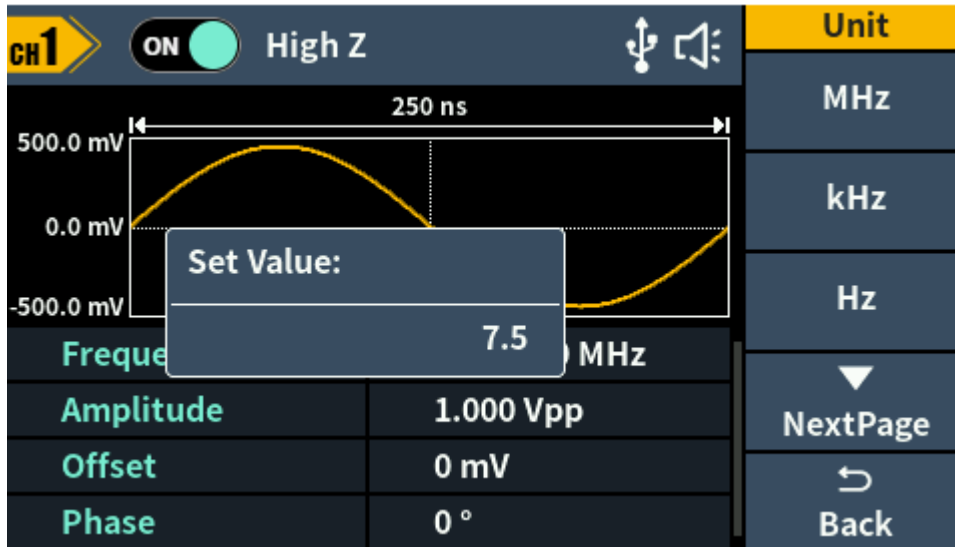

Figure 5-3: Use the numeric keypad to set the frequency

Set the amplitude

Press the **Amplitude/High Level** softkey to confirm whether the **Amplitude** menu item is highlighted; if not, press the **Amplitude/High Level** softkey to switch to **Amplitude**. In **Parameter 2** of Figure 5-2, a blinking cursor appears in the parameter value of amplitude. Turn the **knob** to change the value directly, or use the **numeric keypad** to input the desired value and choose the unit.

Set the offset

Press the **Offset/Low Level** softkey to confirm whether the **Offset** menu item is highlighted; if not, press the **Offset/Low Level** softkey to switch to **Offset**. In **Parameter 3** of Figure 5-2, a blinking cursor appears in the parameter value of offset. Turn the **knob** to change the value directly, or use the **numeric keypad** to input the desired value and choose the unit.

Set the high level

Press the **Amplitude/High Level** softkey to confirm whether the **High Level** menu item is highlighted; if not, press the **Amplitude/High Level** softkey to switch to **High Level**. In **Parameter 2** of Figure 5-2, a blinking cursor appears in the parameter value of high level. Turn the **knob** to change the value directly, or use the **numeric keypad** to input the desired value and choose the unit.

Set the low level

Press the **Offset/Low Level** softkey to confirm whether the **Low Level** menu item is highlighted; if not, press the **Offset/Low Level** softkey to switch to **Low Level**. In **Parameter 3** of Figure 5-2, a blinking cursor appears in the

parameter value of low level. Turn the **knob** to change the value directly, or use the **numeric keypad** to input the desired value and choose the unit.

Set the Phase

Press the **Phase** softkey, the **Phase** menu item is highlighted. In **Parameter 4** of Figure 5-2, a blinking cursor appears in the parameter value of Phase. Turn the **knob** to change the value directly, or use the **numeric keypad** to input the desired value and choose the unit.

Output Square Wave

Press , the screen displays the user interface of the square wave. The Square waveform parameters can be set by operating the Square setting menu on the right.

The square wave menu includes: **Frequency/Period**, **Amplitude/High Level**, **Offset/Low Level**, and **Phase**.

To set the Frequency/Period, Amplitude/High Level, Offset/Low Level, Phase, please refer to *Output Sine Wave* on page 6.

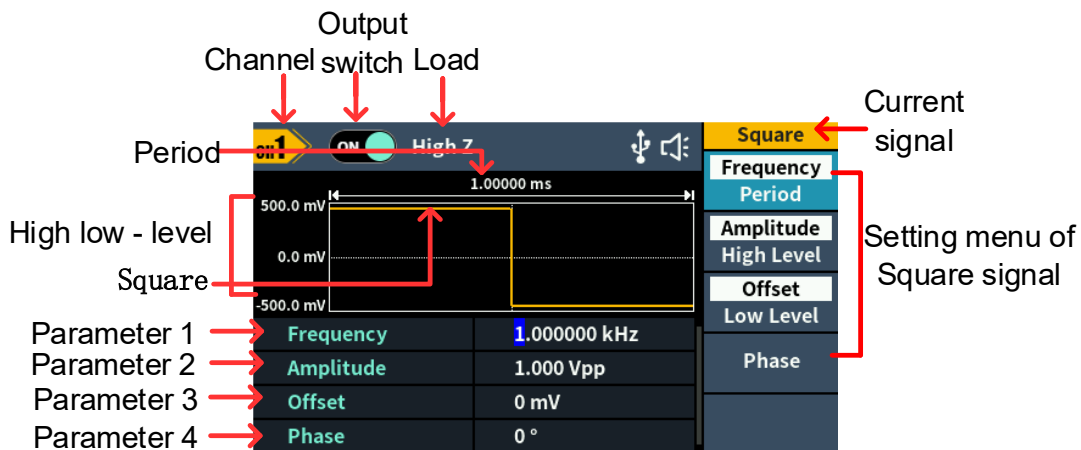



Figure 5-4: Square wave user interface

Output Ramp Wave

Press , the screen displays the user interface of the ramp wave. The Ramp waveform parameters can be set by operating the Ramp setting menu on the right.

The ramp menu includes: **Frequency/Period**, **Amplitude/High Level**, **Offset/Low Level**, **Phase**, and **Symmetry**.

To set the Frequency/Period, Amplitude/High Level, Offset/Low Level, Phase, please refer to *Output Sine Wave* on page 6.

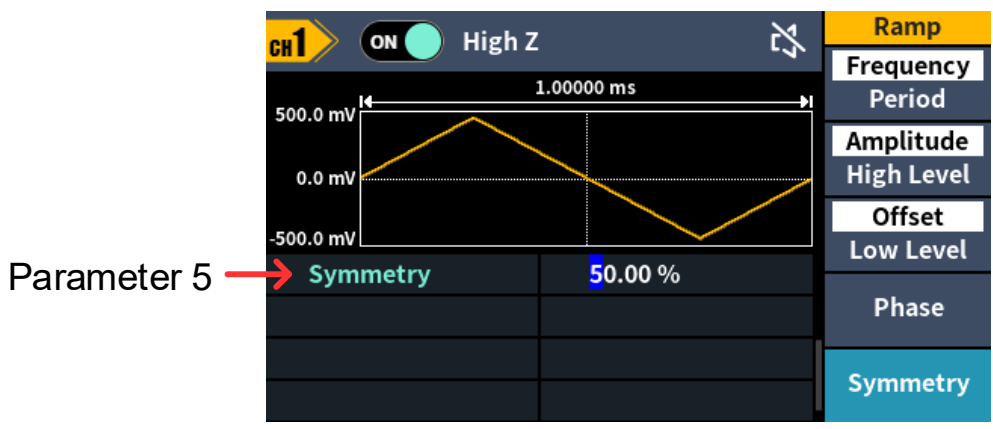
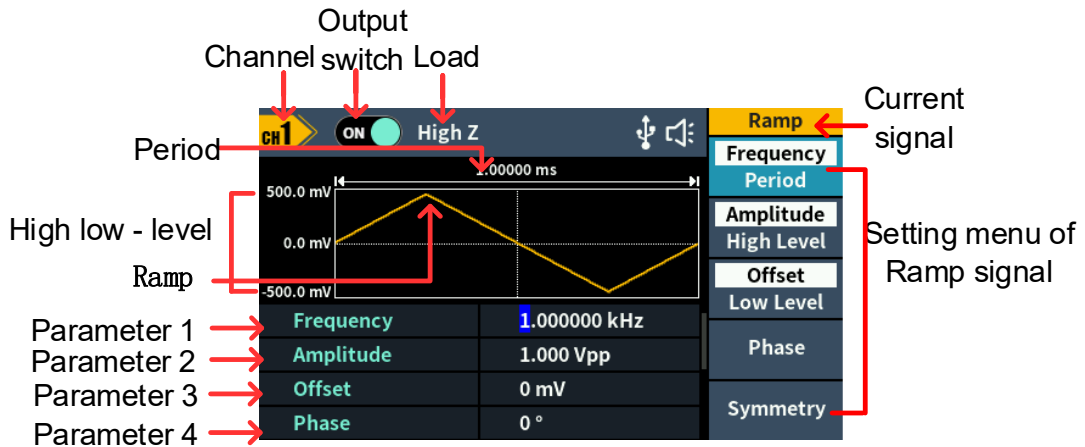

Figure 5-5: Ramp wave user interface

Set the symmetry

Press the **Symmetry** softkey, the **Symmetry** menu item is highlighted. In **Parameter 5** of Figure 5-5, a blinking cursor appears in the parameter value of symmetry. Turn the **knob** to change the value directly, or use the **numeric keypad** to input the desired value and choose the unit.



Figure 5-6: Set the symmetry of ramp wave

Glossary

Symmetry: Sets the percentage of the period during which the ramp waveform is rising.

Output Pulse Wave

Press , the screen displays the user interface of the pulse wave. The Pulse waveform parameters can be set by operating the Pulse setting menu on the right.

The pulse wave menu includes: **Frequency/Period, Amplitude/High Level, Offset/Low Level, Phase, Width/Duty, and Rise/Fall.**

To set the Frequency/Period, Amplitude/High Level, Offset/Low Level, Phase, please refer to *Output Sine Wave* on page 6.

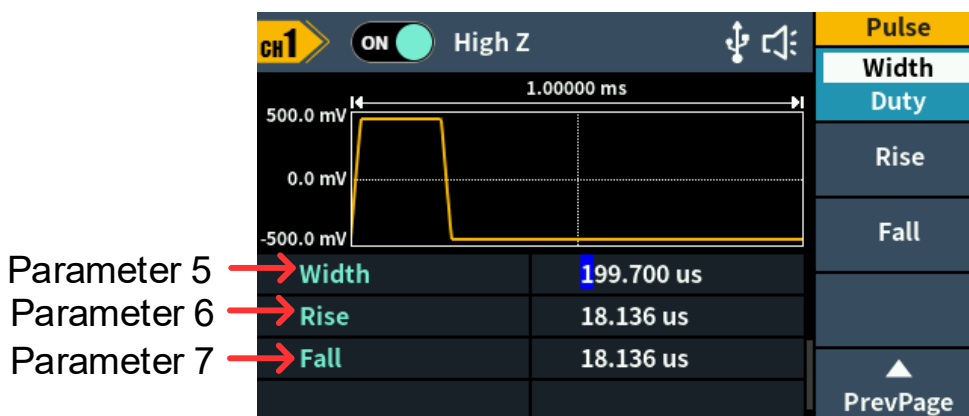
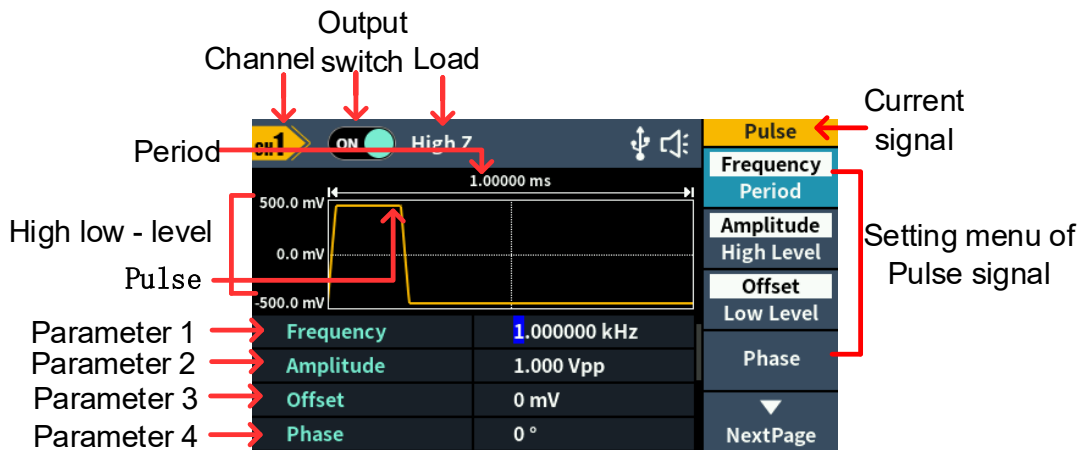

Figure 5-7: Pulse wave user interface

Set the pulse width/duty cycle

Press the **Width/Duty** softkey, the chosen menu item is highlighted. Press the **Width/Duty** softkey to switch between Pulse Width and Duty Cycle. In

Parameter 5 of Figure 5-7, a blinking cursor appears in the parameter value. Turn the **knob** to change the value directly, or use the **numeric keypad** to input the desired value and choose the unit.

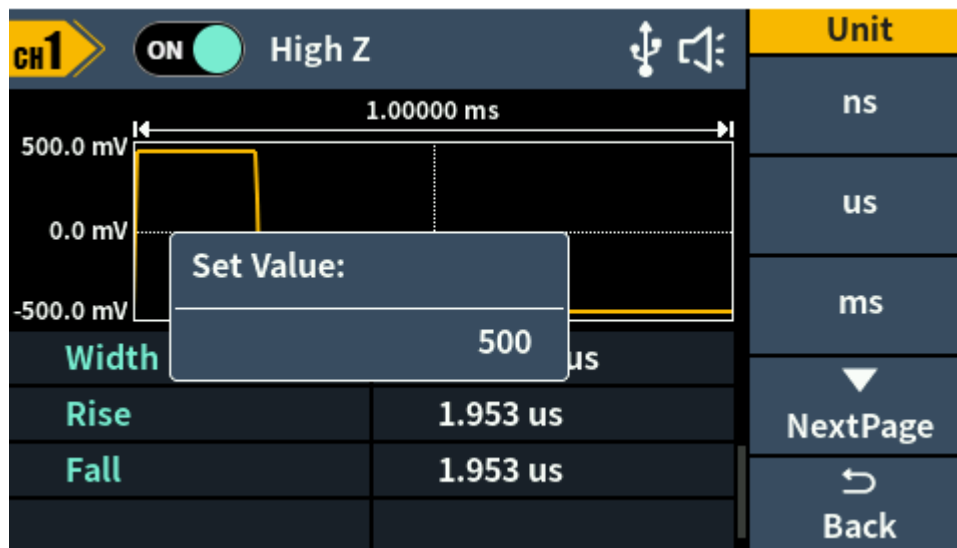

Figure 5-8: Set the pulse width

Set the rising time

Press the **Rise** softkey, the chosen menu item is highlighted. Press the **Rise** softkey to switch between Rising Time and Falling Time. In **Parameter 6** of Figure 5-7, a blinking cursor appears in the parameter value. Turn the **knob** to change the value directly, or use the **numeric keypad** to input the desired value and choose the unit.

Set the falling time

Press the **Fall** softkey, the chosen menu item is highlighted. Press the **Fall** softkey to switch between Rising Time and Falling Time. In **Parameter 7** of Figure 5-7, a blinking cursor appears in the parameter value. Turn the **knob** to change the value directly, or use the **numeric keypad** to input the desired value and choose the unit.

Glossary

Pulse Width

PW is an abbreviation for pulse width and is divided into positive pulse width and negative pulse width.

The positive pulse width is the time interval from 50% of the rising edge to 50% of the adjacent falling edge.

The negative pulse width is the time interval from 50% of the falling edge to 50% of the adjacent rising edge.

The pulse width is determined by the period and duty cycle of the signal. The calculation formula is pulse width = period * duty cycle.

The settable range of pulse width is limited by the "minimum pulse width" and "pulse period"

$$\text{Pulse width} \geq \text{minimum pulse width}$$

$$\text{Pulse width} \leq \text{pulse period} - \text{minimum pulse width}$$

Duty Cycle

In a series of ideal pulse sequences (such as a square wave), the ratio of the duration of the positive pulse to the total pulse period.

The pulse duty cycle is associated with the pulse width, and modifying one of the parameters will automatically modify the other parameter. The pulse duty cycle is limited by the "minimum pulse width" and "pulse period".

$$\text{Pulse duty cycle} \geq \text{minimum pulse width} \div \text{pulse period} \times 100\%$$

$$\text{Pulse duty cycle} \leq (1 - 2 \times \text{minimum pulse width} \div \text{pulse period}) \times 100\%$$

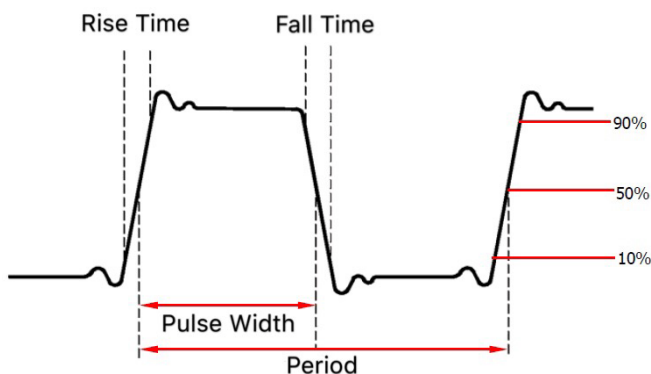

Rise time / Fall time

The rise time is defined as the time required for the pulse amplitude to rise from 10% threshold to 90% threshold;

The fall time is defined as the time required for the pulse amplitude to fall from 90% threshold to 10% threshold as shown in the figure above.

Output Noise Wave

The noise wave which the generator output is white noise. Press , the screen displays the user interface of the noise wave. The Noise waveform parameters can be set by operating the Noise setting menu on the right.

The noise wave has no frequency and periodic parameters.

The noise wave menu includes: **Amplitude/High Level, Offset/Low Level.**

To set the Amplitude/High Level, Offset/Low Level, please refer to *Output Sine Wave* on page 6.

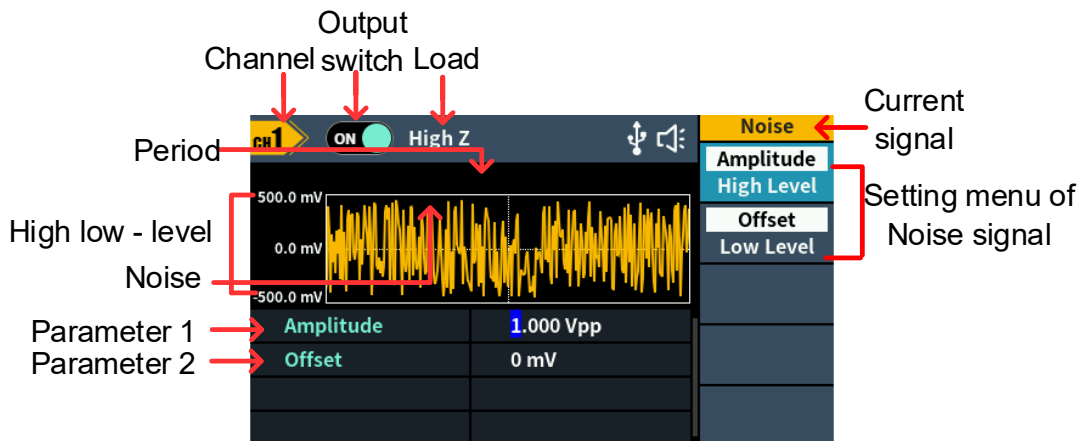



Figure 5-9: Noise wave user interface

Output Arbitrary Wave

Press , the screen displays the user interface of the arbitrary wave. The Arbitrary waveform parameters can be set by operating the Arbitrary setting menu on the right.

The arbitrary wave menu includes: **Frequency/Period, Amplitude/High Level, Offset/Low Level, Phase, Built-in Waveform** and **Store**.

To set the Frequency/Period, Amplitude/High Level, Offset/Low Level, Phase, please refer to *Output Sine Wave* on page 6.

The Arbitrary signal consists of two types: the system built-in waveform and the customized waveform loaded from PC software which is edited by users.

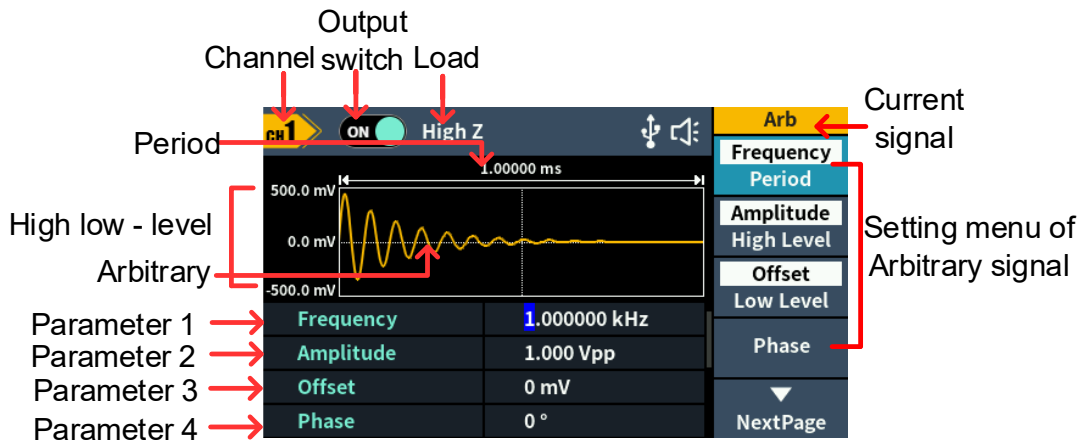

Figure 5-10: Arbitrary wave user interface

Select build-in wave (including DC)

There are 167 types of waveforms built in the generator, the number of waveform points is 8192 points, and the highest upper limit frequency is 10MHz. To select a built-in waveform, the steps are as follows:

(1) Press the **Arb** wave button, then press the **NextPage** button to enter the NextPage menu.

(2) Press the **Built-in** softkey to enter the built-in wave menu.

(3) Press **Common**, **Medical Treatment**, **Standard** softkeys to select the built-in wave type.

Press **NextPage** softkey to enter the next page, select the built-in wave type: **Maths**, **Trigonometric**, **Window Function**.

Press **NextPage** softkey to enter the next page, select the built-in wave type: **Engineering**, **Seg Mod** (Segmentation Modulation) and **Fan test**.

For example, select **Common** to enter the interface shown below.

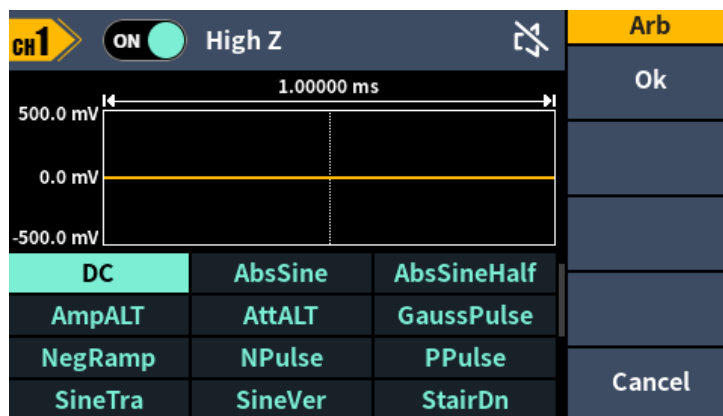

(4) Turn the **knob** to select the desired waveform, for example, select **DC**. Press the **OK** softkey to enter the Arbitrary function.

Note: DC is a type of built-in waveform, located in the **Common** type, named "DC".

Built-in wave list

5.Panel Operation

Name	Description
Common	
DC	Direct current
AbsSine	Absolute sine
AbsSineHalf	Absolute half-sine
AmpALT	Gain oscillation curve
AttALT	Attenuation oscillation curve
GaussPulse	Gauss pulse
NegRamp	Negative ramp
NPulse	Negative pluse
PPulse	Positive pluse
SineTra	Sine-Tra wave
SineVer	Sine-Ver wave
StairDn	Stair downward
StairUD	Stair upward/downward
StairUp	Stair upward
Trapezia	Trapezia
Medical treatment	
Heart	Heart
Cardiac	Cardiac
LFPulse	Low frequency pulse electrotherapy waveform
Tens1	Neuroelectric stimulation therapy waveform 1
Tens2	Neuroelectric stimulation therapy waveform 2
Tens3	Neuroelectric stimulation therapy waveform 3
EOG	Electrooculogram
EEG	electroencephalogram
Pulseilogram	Ordinary pulse curve
ResSpeed	Ordinary expiratory flow rate curve
Standard	
Ignition	Automobile internal combustion engine ignition waveform
TP2A	Automotive transients due to inductance in the wiring
SP	Automobile starting profile with oscillation
VR	Working voltage profile of the car when resetting
TP1	Automotive transients due to power cuts
TP2B	Car transients due to startup switching off
TP4	Car working profile during start-up
TP5A	Car transients due to the power cut of battery
TP5B	Car transients due to the power cut of battery
SCR	Sintering temperature release map
Surge	Surge signal
Maths	
Airy	Airy function
Besselj	Type I Bessel function

5.Panel Operation

Bessely	Type II Bessel function
Cauchy	Cauchy distribution
X^3	Cubic function
Erf	Error function
Erfc	Remnant error function
ErfcInv	Anti-complement error function
ErfInv	Inverse error function
Dirichlet	Dirichlet function
ExpFall	Exponential decline function
ExpRise	Exponential rise function
Laguerre	Four Laguerre polynomials
Laplace	Laplace distribution
Legend	Five Legendre polynomials
Gauss	Gaussian distribution, also known as the normal distribution
HaverSine	Semi-positive function
Log	Base 10 logarithmic function
LogNormal	Lognormal distribution
Lorentz	Lorentz function
Maxwell	Maxwell distribution
Rayleigh	Rayleigh distribution
Versiera	Tongue line
Weibull	Weber distribution
Ln(x)	Natural logarithmic waveform
X^2	Square function
Round	Round wave
Chirp	Linear frequency modulation
Rhombus	Diamond wave
Trigonometric metric	
CosH	Hyperbolic cosine
Cot	Cotangent function
CotH	Hyperbolic cotangent
CotHCon	Concave hyperbolic cotangent
CotHPro	Raised hyperbolic cotangent
CscCon	Recessed cosecant
Csc	Cosecant
CscPro	Raised cosecant
Csch	Hyperbolic cosecant
CschCon	Depressed hyperbolic cosecant
CschPro	Raised hyperbolic cosecant
RecipCon	Reciprocal of the depression
RecipPro	Raised countdown
SecCon	Depression secant
SecPro	Raised secant

5.Panel Operation

SecH	Hyperbolic secant
Sinc	Sinc function
SinH	Hyperbolic sine
Sqrt	Square root function
Tan	Tangent function
TanH	Hyperbolic tangent
ACos	Inverse cosine function
ACosH	Inverse hyperbolic cosine function
ACot	Anti-cotangent function
ACotCon	Inverse cotangent function
ACotPro	Raised inverse cotangent function
ACotH	Inverse hyperbolic cotangent function
ACotHCon	Inverse hyperbolic cotangent function
ACotHPro	Raised inverse hyperbolic cotangent function
Acsc	Anti-cosecting function
ACscCon	Concave inverse cosecting function
ACscPro	Raised anti-cosecting function
AcscH	Anti-hyperbolic cosecant
ACscHCon	Inverse hyperbolic cotangent function
ACscHPro	Raised inverse hyperbolic cosecant function
Asec	Inverse cut function
ASecCon	Inverse tangent function
ASecPro	Raised arctangent function
ASecH	Inverse hyperbolic secant function
ASin	Inverse sine function
ASinH	Inverse hyperbolic sine function
ATan	Arc tangent function
ATanH	Inverse hyperbolic tangent function
Window function	
Bartlett	Bartlett window
BarthannWin	Modified Bartlett window
Blackman	Blackman window
BlackmanH	BlackmanH window
BohmanWin	BohmanWin window
Boxcar	Rectangular window
ChebWin	Chebyshev window
FlatopWin	Flat top window
Hamming	Hamming window
Hanning	Hanning window
Kaiser	Kaiser window
NuttakkWub	The smallest four Blackman-Harris windows
ParzenWin	Parzen window
TaylorWin	Taylaor window

5. Panel Operation

Triang	Triangle window, also call Fejer window
TukeyWin	Tukey window
Engineering Window	
Butterworth	Butterworth filter
Combin	Combined function
CPulse	C-Pulse signal
CWPulse	CW pulse signal
RoundHalf	Half-round wave
BandLimited	Band limited signal
BlaseiWave	Blasting vibration "time-vibration speed" curve
Chebyshev1	Type I Chebyshev filter
Chebyshev2	Type II Chebyshev filter
DampedOsc	Damped oscillation "time-displacement" curve
DualTone	Dual audio signal
Gamma	Gamma signal
GateVibar	Gate self-vibration signal
LFMPulse	Chirp signal
MCNoise	Mechanical construction noise
Discharge	NiMH battery discharge curve
Quake	Seismic wave
Radar	Radar signal
Ripple	Ripple
RoundsPM	RoundsPM wave
StepResp	Step response signal
SwingOsc	Swing oscillation kinetic energy-time curve
TV	TV signal
Voice	Voice signal
Segement Modulation	
AM	Sinusoidal segmented AM wave
FM	Sinusoidal segmented FM wave
PM	Sinusoidal segmented PM wave
PWM	Pulse width segmented PWM wave
Fan test	
64n/1024	Order adjustment (n is an integer, the range is 0 - 16)

Store

Users can Load customized waveform to the device by PC software. Install PC software first. (You may follow P53 "Communication with PC").

Press  , press **NextPage** then Store button to enter File system.

Reading waveform

- (1) Please visit our official website to obtain the installation package and decompress it.
- (2) Double click " Waveform Editor " icon to run the software.

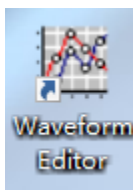

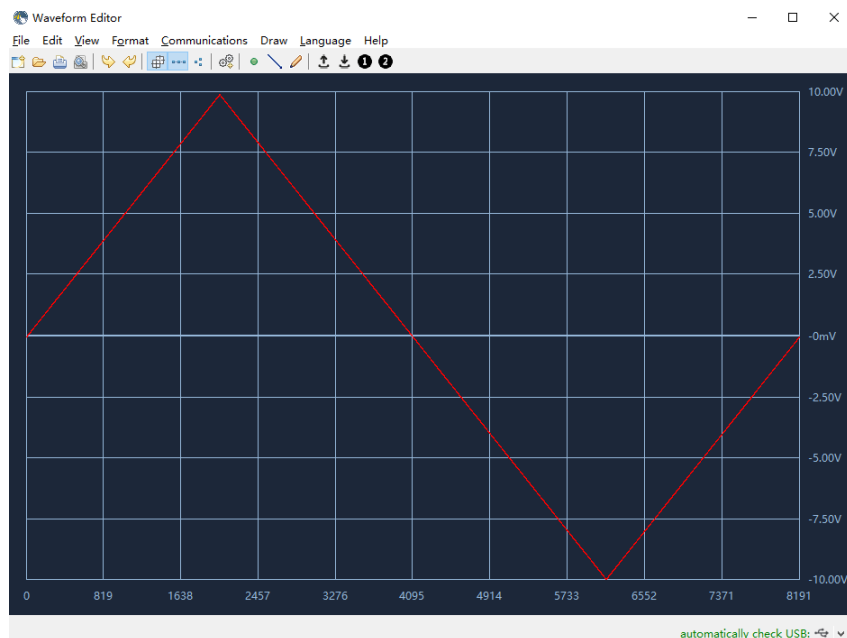

- (3) Enter the "Waveform Editor" interface.
- (4) Select the required waveform on the instrument.
- (5) Under Waveform Editor software interface, click "Read Waveform Icon  " button, and the waveform will be read and displayed on the screen.



Write and Recall waveform

We can use the Line Draw, Hand Draw and Point Edit mode in the Waveform Editor to edit the required waveform, and save and display it on the instrument by writing.

- (1) Under Waveform Editor software interface, Click "Write waveform Icon  " button.
 - (2) After the writing is successful, the "File transfer completed" prompt box will be displayed in the waveform editor. Click "OK".
 - (3) On the instrument, the screen shows "Any wave has been updated to USERX(X is 0-15)".
 - (4) Press the  Arb Wave button ,then press the **NextPage** button to enter the NextPage menu.
 - (5) Press the **Store** soft key to enter the file system, and then press the **Enter** soft key to enter the file system. Select the file name "USERX" that has just written the waveform.
 - (6) Press the **Call out** soft key, the screen displays "File read successfully", then press the  arbitrary wave key, the written waveform can be viewed on the instrument.
- Note:** The file size is displayed on the right of the file. If 0B is displayed, the file is empty.

Generate Sweep (Sweep)

In sweep mode, the generator varies its output from the start frequency to the stop frequency within the specified sweep time. Sweep can be generated by **Sine**, **Square**, **Ramp** or **Arbitrary** wave (except DC).

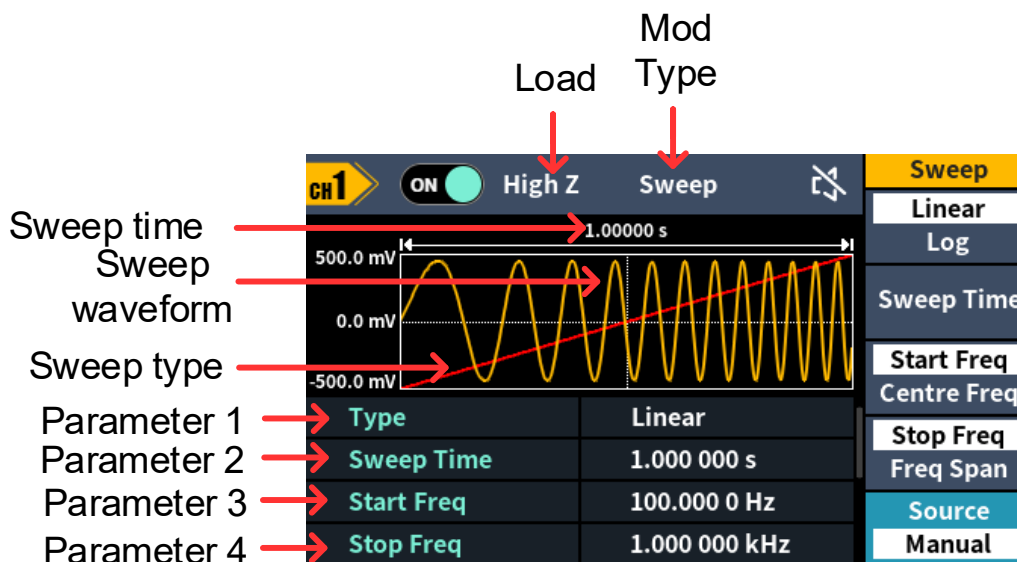







Figure 5-11: Sweep mode user interface

How to set the parameters of Sweep

- (1) When the output signal is **Sine**, **Square**, **Ramp** or **Arbitrary** wave (except DC), press the front panel **Mode** function key, then press the **Sweep** to enter the sweep mode.
- (2) Press , , , or  to select the sweep waveform. For example, when selecting a sine wave, press  to display the sweep waveform and parameters, and change the parameters. For details, please refer to *Output Sine Wave* on page 6. Press the  to return to the sweep mode interface or press the **Mode** to return to the modulation selection mode.
- (3) Press the **Sweep** softkey to switch the sweep type. When **Linear** is selected, the output frequency of the instrument varies linearly during the sweep. When **Log** is selected, the output frequency of the instrument varies in a logarithmic fashion during the sweep.
- (4) Press the **Sweep Time** softkey to set the sweep time, the time span of the sweep for which the frequency changes from the start frequency to stop frequency. The range is from 1ms to 500s.
- (5) Start frequency and stop frequency are the upper and lower limits of the

frequency for frequency sweep. The generator sweeps from the start frequency to the stop frequency and then returns back to the start frequency. Press the **Start Freq/Centre Freq** softkey to highlight **Start Freq**, note that **Stop Freq** in **Stop Freq/Freq Span** is also highlighted, input the desired frequencies.

You can also set the frequency boundaries of frequency sweep through center frequency and frequency span.

$$\text{Center Frequency} = (\text{Start Frequency} + \text{Stop Frequency}) / 2$$

$$\text{Frequency Span} = \text{Stop Frequency} - \text{Start Frequency}$$

Press the **Start Freq/ Centre Freq** softkey to highlight **Centre Freq**, note that **Freq Span** in **Stop Freq/Freq Span** is also highlighted, input the desired frequencies.

For different instrument models and different waveforms, the setting ranges of frequency are different. For detailed information, please refer to **Sweep characteristics** in *Specification* on page 54.

- (6) Press the **source** softkey to select the trigger source.

Internal means using the internal trigger source.

External means using the **Mod/FSK/Trig Sync/Ext Mod/Trig/FSK** connector at the rear panel to input the external trigger signal. A sweep will be generated once the connector gets a TTL pulse with specified polarity.

Manual means using manual trigger. In sweep interface, each time you press the **knob** under the current channel on the front panel, a sweep will be generated.

Generate Burst (Burst)

Press the **Mode** key on the front panel, then press the **Burst** to generate versatile waveforms in burst. Burst can last for certain times of waveform cycle (N-Cycle Burst), or to be controlled by external gated signals (Gated Burst). Burst can apply to **Sine**, **Square**, **Ramp**, **Pulse** and **Arbitrary** waveforms (except DC).

Glossary

Burst:

The set of pulses transmitted together is called a "burst". The various signal generators are commonly referred to as the BURST function.

N cycle burst:

Contains a specific number of waveform cycles, each of which is initiated by a trigger event.

Gated burst:

Use external department signals to control when waveform burst waveforms are active

Set N-Cycle Burst

In N Cycle mode, the generator will output waveform with specified number of cycles after receiving trigger signal.

The waveform of the cyclic pulse train refers to the waveform of the specified number of cycles output after the signal generator receives the trigger signal

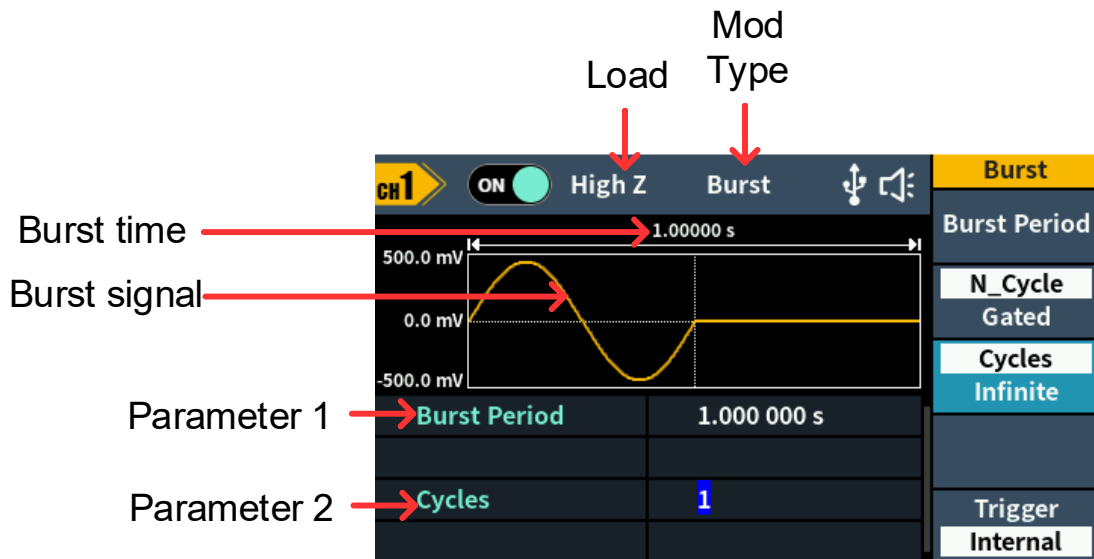









Figure 5-12: N-Cycle burst user interface

- (1) When the output signal is **Sine, Square, Ramp, Pulse** or **Arbitrary** wave (except DC), press the front panel **Mode** function key, then press the **Burst** to enter the burst mode.
- (2) Press , , , , or  to select the burst waveform. For example, when selecting a sine wave, press  to display the burst waveform and parameters, and change the parameters. For details, please refer to *Output Sine Wave* on page 6. Press the  to return to the burst mode interface or press the **Mode** to return to the modulation selection mode.

Note: Before configuring the waveform parameters, you must first select

the channel you want to configure. You can press the **CH1/CH2** key to switch the channel user interface.

- (3) Press the **N_Cycle/Gated** softkey to highlight **N_Cycle**.
- (4) Press the **Cycles/Infinite** softkey to highlight **Cycles**, input the number of cycles, which is the number of waveform cycles to be output for each N-cycle pulse train. The range is from 1 to 60 000.
When **Infinite** is selected, the cycle number of the waveform is set as an infinite value. The generator outputs a continuous waveform after receiving trigger signal.

Note:

- If needed, Burst Period will increase to cater to the specific number of cycles.
 - For an infinite-cycle Burst, **External** or **Manual** Trigger is needed to activate burst.
-

- (5) Burst trigger source could be internal, external or manual. The generator will generate a burst output when a trigger signal is received and then wait for the next trigger. Press the **Trigger** to select the source.

Internal means using the internal trigger source. The generator can only output N-cycle burst and the burst frequency is determined by the burst period. Burst period is only available when **Cycles** and **Internal** trigger is highlighted. Press the **Burst Period** softkey to set the burst period, which is the time from the start of a burst to the start of the next burst. The range is from 20 ns to 500 s (Min = Cycles * Period).

External means using the **Sync/Ext Mod/Trig/FSK** connector at the rear panel to input the external trigger signal. A burst will be generated once the connector gets a TTL pulse with specified polarity.

Manual means using manual trigger. In N-cycle burst interface, each time you press the **Knob** under the current channel on the front panel, a burst will be generated.

Set Gated Burst

In gated burst mode, the generator controls the waveform output according to the external signal level from the **Sync/Ext Mod/Trig/FSK** connector at the rear panel. Gated burst could only be triggered by external trigger source. Waveform functions which support gated burst are **Sine**, **Square**, **Ramp**, **Pulse** and **Arbitrary** waveforms (except DC).

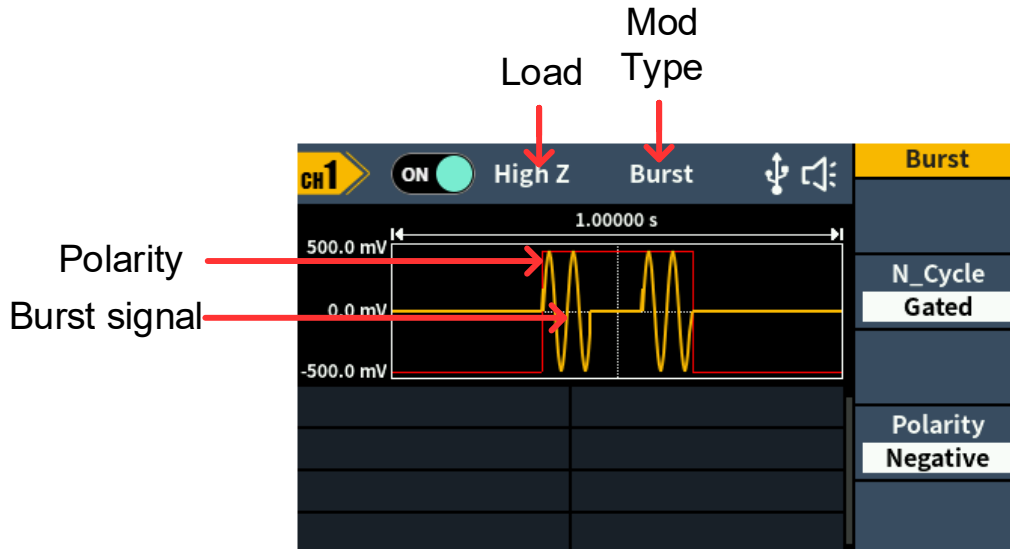









Figure 5-13: Gated burst user interface

(1) When the output signal is **Sine**, **Square**, **Ramp**, **Pulse** or **Arbitrary** wave (except DC), press the front panel **Mode** function key ,then press the **Burst** to enter the burst mode.

(2) Press , , ,  or  to select the burst waveform. For example, when selecting a sine wave, press  to display the burst waveform and parameters, and change the parameters. For details, please refer to *Output Sine Wave* on page 6. Press the  to return to the burst mode interface or press the **Mode** to return to the modulation selection mode.

Note: Before configuring the waveform parameters, you must first select the channel you want to configure. You can press the **CH1/CH2** key to switch the channel user interface.

(3) Press the **N_Cycle/Gated** softkey to highlight **Gated**.

(4) Press the **Polarity** softkey to set the gated polarity as Positive (or Negative). The generator outputs burst waveform only when the gated signal is positive (or negative). When the gated signal is true, the generator outputs a continuous waveform; when the gated signal is false, the generator completes the current period, and then stops and holds on the voltage level corresponding to the initial burst phase of the selected waveform.

Output the Modulated Waves

Supported modulation types include: AM (Amplitude Modulation), FM (Frequency Modulation), PM (Phase Modulation), PWM (Pulse Width Modulation), ASK (Amplitude Shift Keying), PSK (Phase Shift Keying), FSK

(Frequency Shift Keying), 3FSK (Ternary Frequency Shift Keying), 4FSK (Quadrature Frequency Shift Keying), BPSK (Biphase Phase Shift Keying), QPSK (Quadrature Phase Shift Keying), OSK (Oscillating Keying), SUM (Sum Modulation), DSBAM (Double-Sideband Amplitude Modulation).

Press the **Mode** function key, select the modulation type, to enter the setup menu. To turn off the modulation, press the **Mode** function button again.

Note: The following output modulation waveform uses CH1 as an example. If you need to set CH2, please refer to CH1 operation.

AM (Amplitude Modulation)

The modulated waveform consists of the carrier wave and the modulating wave. For AM, the amplitude of the carrier wave varies with the instantaneous voltage of the modulating wave. The AM user interface is shown below.

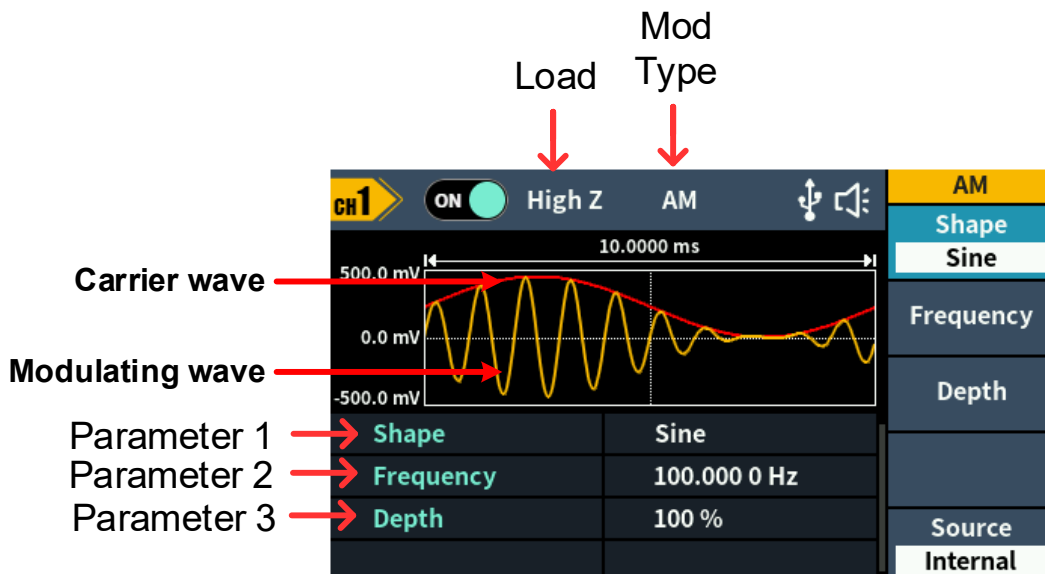





Figure 5-14: AM user interface

How to set the parameters of AM

- (1) Press the **Mode** function key, then press the **AM** softkey to enter AM user interface.
- (2) **Select carrier wave shape:**
The carrier wave can be **Sine**, **Square**, **Ramp**, or **Arbitrary** wave (except DC). Press , , , or  to select a desired carrier wave shape.
- (3) **Set carrier wave parameters:**
Press the **wave shape key** of the selected carrier wave to display the waveform and parameters of the carrier wave. You can change the parameters of the carrier wave. Press the corresponding carrier waveform

key to return to the modulation mode interface or press the **Mode** key to return to select the modulation selection mode.

(4) Select modulating wave source:

Press the **Source** softkey to select the modulating wave source.

If you select **External**, use the **Sync/Ext Mod/Trig/FSK** connector at the rear panel to input the external modulating signal, the AM setting is completed.

If you select **Internal**, continue with the following steps.

(5) Select modulating wave shape:

Press the **Shape** softkey, then press the **Sine**, **Square**, **Ramp** or **Noise** softkey to select the modulating wave.

(6) Set modulating wave frequency:

Press the **Frequency** softkey to set the modulating wave frequency. The range is 2 mHz – 100kHz (for internal source only).

(7) Set modulation depth:

Press the **Depth** softkey to set the modulation depth. The range is 0% - 100%.

Glossary

AM frequency

The frequency of the modulating waveform.

Modulation Depth

The amplitude range of modulating waveform. In 0% modulation, the output amplitude is half of the specified value. In 100% modulation, the output amplitude is equal to the specified value. For an external source, the depth of AM is controlled by the voltage level of the signal connected to the **Sync/Ext Mod/Trig/FSK** connector at the rear panel. +1 V corresponds to the currently set depth 100%.

DSBAM (Double Sideband AM)

The generator supports two kinds of amplitude modulation: normal AM and Double Sideband AM. In normal AM, the modulated waveform contains carrier components. As the carrier components do not carry information, the modulation efficiency is low. To improve the modulation efficiency, you can suppress the carrier components on the basis of the normal AM. At this point, all the modulated waveform components carry information. This mode is called DSBAM (Double Sideband suppressed carrier modulation). The DSBAM user interface is shown below.

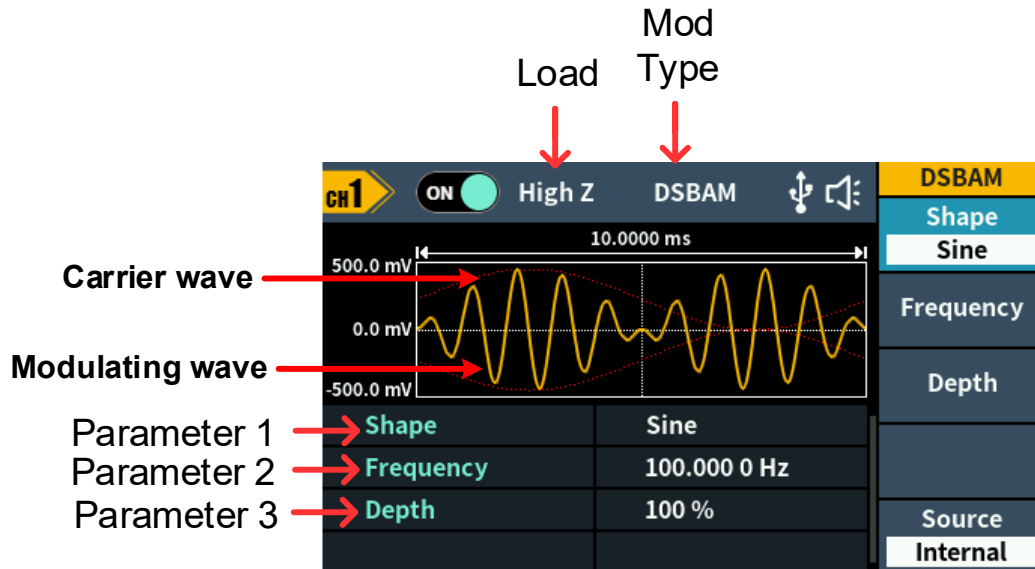





Figure 5-15: DSBAM user interface

How to set the parameters of DSBAM

- (1) Press the **Mode** function key, then press the **DSBAM** softkey to enter DSBAM user interface.
- (2) **Select carrier wave shape:**
The carrier wave can be **Sine**, **Square**, or **Ramp**. Press , , or  to select a desired carrier wave shape.
- (3) **Set carrier wave parameters:**
Press the **wave shape key** of the selected carrier wave to display the waveform and parameters of the carrier wave. You can change the parameters of the carrier wave. Press the corresponding carrier waveform key to return to the modulation mode interface or press the **Mode** key to return to select the modulation selection mode.
- (4) **Select modulating wave source:**
Press the **Source** softkey to select the modulating wave source.
If you select **External**, use the **Sync/Ext Mod/Trig/FSK** connector at the rear panel to input the external modulating signal, the DSBAM setting is completed.
If you select **Internal**, continue with the following steps.
- (5) **Select modulating wave shape:**
Press the **Shape** softkey, then press the **Sine**, **Square**, or **Ramp** softkey to select the modulating wave.
- (6) **Set modulating wave frequency:**
Press the **AM Frequency** softkey to set the modulating wave frequency. The range is 2 mHz – 100kHz (for internal source only).
- (7) **Set modulation depth:**
Press the **Depth** softkey to set the modulation depth. The range is 0% -

100%

FM (Frequency Modulation)

The modulated waveform consists of the carrier wave and the modulating wave. For FM, the frequency of the carrier wave varies with the instantaneous voltage of the modulating wave. The FM user interface is shown below.

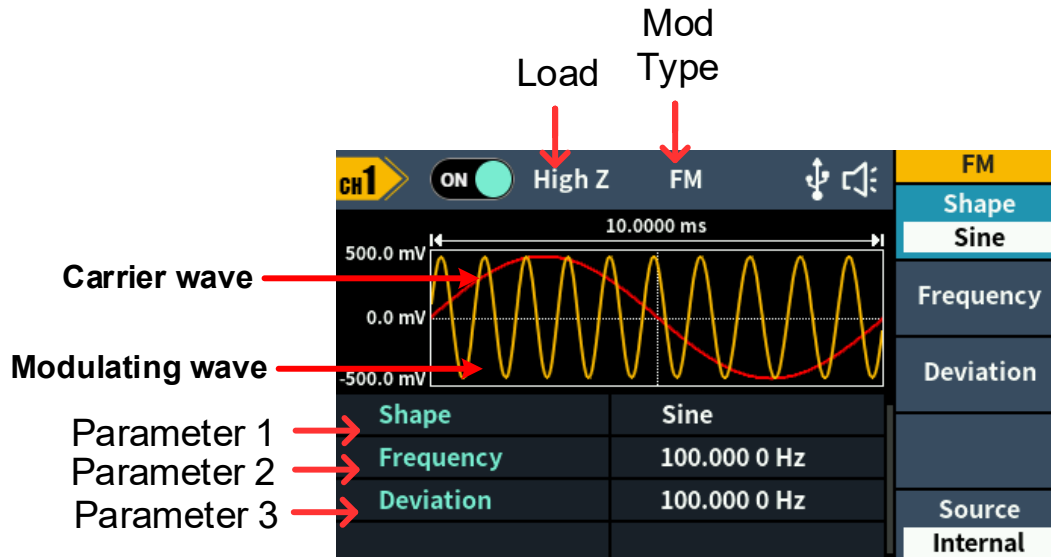





Figure 5-16: FM user interface

How to set the parameters of FM

- Press the **Mode** function key, then press the **FM** softkey to enter FM user interface.
- Select carrier wave shape:**
The carrier wave can be **Sine**, **Square**, **Ramp**, or **Arbitrary** wave (except DC). Press , , , or  to select a desired carrier wave shape.
- Set carrier wave parameters:**
Press **the wave shape key** of the selected carrier wave to display the waveform and parameters of the carrier wave. You can change the parameters of the carrier wave. Press the corresponding carrier waveform key to return to the modulation mode interface or press the **Mode** key to return to select the modulation selection mode.
- Select modulating wave source:**
Press the **Source** softkey to select the modulating wave source.
If you select **External**, use the **Sync/Ext Mod/Trig/FSK** connector at the rear panel to input the external modulating signal, then skip ahead to **step (7)**.
If you select **Internal**, continue with the following steps.

(5) **Select modulating wave shape:**

Press the **Shape** softkey, then press the **Sine**, **Square**, **Ramp**, **Noise** softkey to select the modulating wave.

(6) **Set modulating wave frequency:**

Press the **Frequency** softkey to set the modulating wave frequency. The range is 2 mHz – 100kHz (for internal source only).

(7) **Set frequency deviation:**

Frequency deviation is the deviation of the modulating wave frequency relative to the carrier wave frequency. Press the **Deviation** softkey to set the FM frequency deviation. Frequency deviation range: $1 \mu\text{Hz} \leq \text{deviation} < \text{upper limit}$ (upper limit is **carrier frequency** or **carrier maximum frequency minus carrier frequency**, the smaller of the two).

PM (Phase Modulation)

The modulated waveform consists of the carrier wave and the modulating wave. For PM, the phase of the carrier wave varies with the instantaneous voltage of the modulating wave. The PM user interface is shown below.

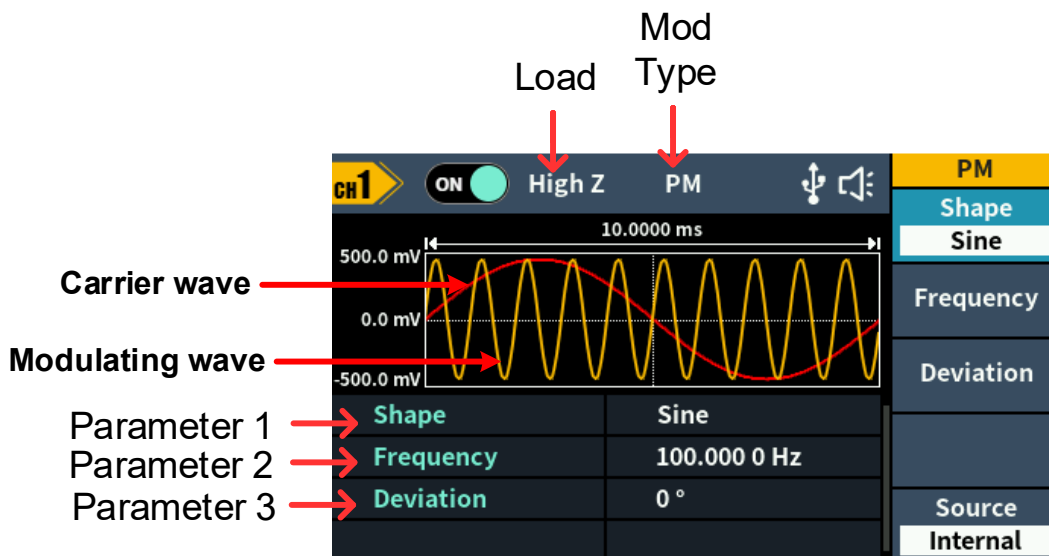

Figure 5-17: PM user interface

How to set the parameters of PM

(1) Press the **Mode** function key, press the **NextPage** softkey, then press the **PM** softkey to enter PM user interface.

(2) **Select carrier wave shape:**

The carrier wave can be **Sine**, **Square**, **Ramp**, or **Arbitrary** wave (except DC). Press , , , or  to select a desired carrier wave

shape.

(3) Set carrier wave parameters:

Press **the wave shape key** of the selected carrier wave to display the waveform and parameters of the carrier wave. You can change the parameters of the carrier wave. Press the corresponding carrier waveform key to return to the modulation mode interface or press the **Mode** key to return to the modulation selection mode.

(4) Select modulating wave source:

Press the **Source** softkey to select the modulating wave source.

If you select **External**, use the **Sync/Ext Mod/Trig/FSK** connector at the rear panel to input the external modulating signal, then skip ahead to **step (7)**.

If you select **Internal**, continue with the following steps.

(5) Select modulating wave shape:

Press the **Shape** softkey, then press the **Sine, Square, Ramp** or **Noise** softkey to select the modulating wave.

(6) Set modulating wave frequency:

Press the **Frequency** softkey to set the modulating wave frequency. The range is 2 mHz – 100kHz (for internal source only).

(7) Set phase deviation:

Phase deviation is the deviation of the modulating wave phase relative to the carrier wave phase. Press the **Deviation** softkey to set the PM phase deviation. The range of phase deviation is from 0° to 180°.

PWM (Pulse Width Modulation)

The modulated waveform consists of the carrier wave and the modulating wave. For PWM, the pulse width of the carrier Pulse wave varies with the instantaneous voltage of the modulating wave. The PWM user interface is shown below.

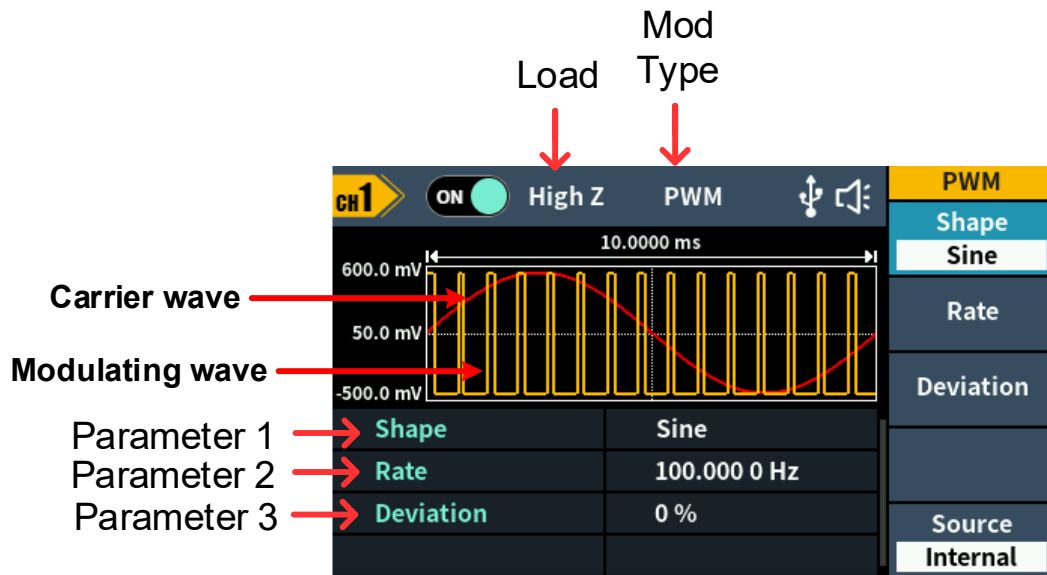



Figure 5-18: PWM user interface

How to set the parameters of PWM

(1) Set carrier wave shape:

PWM can only be used to modulate pulse, so the carrier wave must be **Pulse**.

Press  to set the carrier wave shape.

(2) Press the **Mode** function key, press the **NextPage** softkey, then press the **PWM** softkey to enter PWM user interface.

Note: If **Pulse** wave has not been selected, **PWM** in the menu is unavailable.

(3) Set carrier wave parameters:

Press  to display the waveform and parameters of the carrier wave. You can change the parameters of the carrier wave. Press the corresponding carrier waveform key to return to the modulation mode interface or press the **Mode** key to return to the modulation selection mode.

(4) Select modulating wave source:

Press the **Source** softkey to select the modulating wave source.

If you select **External**, use the **Sync/Ext Mod/Trig/FSK** connector at the rear panel to input the external modulating signal, then skip ahead to **step (7)**.

If you select **Internal**, continue with the following steps.

(5) Select modulating wave shape:

Press the **Shape** softkey, then press the **Sine**, **Square**, **Ramp** or **Noise** softkey to select the modulating wave.

(6) Set modulating wave frequency:

Press the PWM **Rate** softkey to set the modulating wave frequency. The range is 2 mHz – 1 MHz (for internal source only).

(7) Set duty cycle deviation:

Duty cycle deviation is the deviation (in %) of the modulating wave duty cycle relative to the original pulse duty cycle. Press the **Deviation** softkey to set the PWM duty cycle deviation.

Duty cycle deviation range: $0\% \leq \text{deviation} < \text{upper limit}$ (upper limit is **carrier duty cycle** or **100% minus carrier duty cycle**, the smaller of the two).

ASK (Amplitude Shift Keying)

Amplitude Shift Keying modulation is a modulation technique that shifts the output signal amplitude between two amplitudes: the carrier amplitude and modulating amplitude. Carrier wave amplitude shifts to the modulating amplitude with the specified ASK rate, and then returns to the original amplitude. The ASK user interface is shown below.

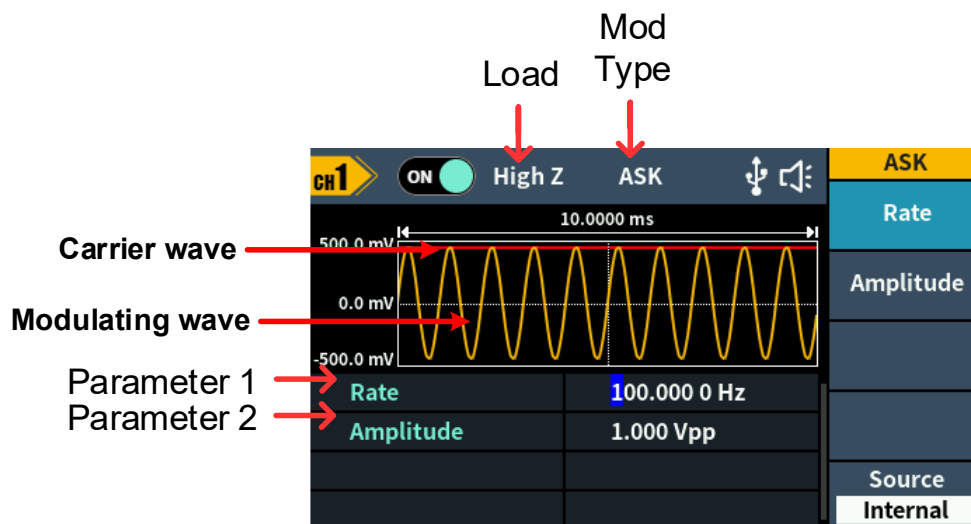





Figure 5-19: ASK user interface

How to set the parameters of ASK

(1) Press the **Mode** function key, press the **NextPage** softkey, then press the **ASK** softkey to enter ASK user interface.

(2) Select carrier wave shape:

The carrier wave can be **Sine**, **Square**, **Ramp**, or **Arbitrary** wave (except DC). Press , , , or  to select a desired carrier wave shape.

(3) Set carrier wave parameters:

Press **the wave shape key** of the selected carrier wave to display the waveform and parameters of the carrier wave. You can change the parameters of the carrier wave. Press the corresponding carrier waveform

key to return to the modulation mode interface or press the **Mode** key to return to the modulation selection mode.

(4) Select modulating wave source:

Press the **Source** softkey to select **Internal** or **External** as the modulating wave source.

If you select **Internal**, the modulating wave is set as a Square with 50% duty cycle. Press the **ASK Rate** softkey to set the ASK rate. The rate at which the output amplitude shifts between the carrier amplitude and the modulating amplitude is determined by ASK rate (for internal source only). The range is 2 mHz – 1 MHz.

If you select **External**, use the **Sync/Ext Mod/Trig/FSK** connector at the rear panel to input the external modulating signal.

(5) Set modulating amplitude:

Press the **Amplitude** softkey to set the modulating amplitude.

PSK (Phase Shift Keying)

Phase Shift Keying modulation is a modulation technique that shifts the output signal phase between two phases: the carrier phase and modulating phase. Carrier wave phase shifts to the modulating phase with the specified PSK rate, and then returns to the original phase. The PSK user interface is shown below.

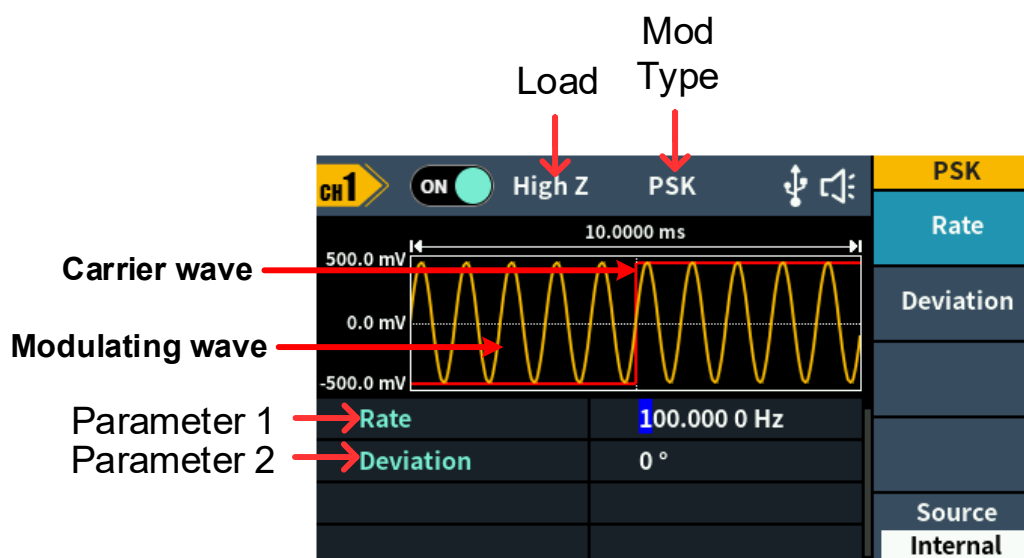





Figure 5-20: PSK user interface

How to set the parameters of PSK

- (1) Press the **Mode** function key, press the **NextPage** softkey twice more, then press the **PSK** softkey to enter PSK user interface.

(2) Select carrier wave shape:

The carrier wave can be **Sine**, **Square**, **Ramp**, or **Arbitrary** wave (except DC). Press , , , or  to select a desired carrier wave shape.

(3) Set carrier wave parameters:

Press the **wave shape key** of the selected carrier wave to display the waveform and parameters of the carrier wave. You can change the parameters of the carrier wave. Press the corresponding carrier waveform key to return to the modulation mode interface or press the **Mode** key to return to the modulation selection mode.

(4) Select modulating wave source:

Press the **Source** softkey to select **Internal** or **External** as the modulating wave source.

If you select **Internal**, the modulating wave is set as a Square with 50% duty cycle. Press the **Rate** softkey to set the PSK rate. The rate at which the output phase shifts between the carrier phase and the modulating phase is determined by PSK rate (for internal source only). The range is 2 mHz – 1 MHz.

If you select **External**, use the **Sync/Ext Mod/Trig/FSK** connector at the rear panel to input the external modulating signal.

(5) Set PSK phase deviation:

Press the **Deviation** softkey to set the modulating phase deviation.

FSK (Frequency Shift Keying)

Frequency Shift Keying modulation is a modulation technique that shifts the output signal frequency between two frequencies: the carrier frequency and hop frequency. The shift frequency (FSK rate) is determined by the internal signal level. The FSK user interface is shown below.

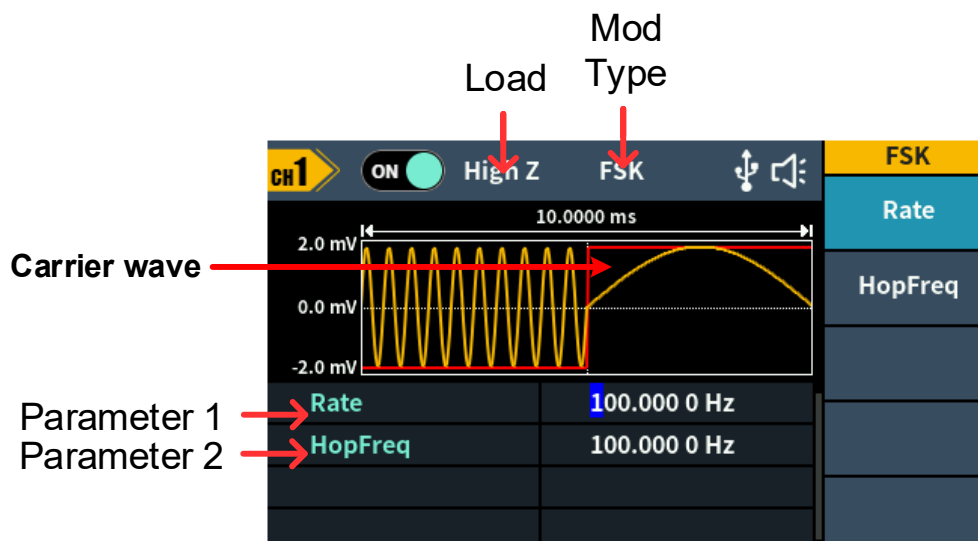





Figure 5-21: FSK user interface

How to set the parameters of FSK

- (1) Press the **Mode** function key, press the **NextPage** softkey, then press the **FSK** softkey to enter FSK user interface.
- (2) **Select carrier wave shape:**
The carrier wave can be **Sine**, **Square**, **Ramp**, or **Arbitrary** wave (except DC). Press , , , or  to select a desired carrier wave shape.
- (3) **Set carrier wave parameters:**
Press **the wave shape key** of the selected carrier wave to display the waveform and parameters of the carrier wave. You can change the parameters of the carrier wave. Press the corresponding carrier waveform key to return to the modulation mode interface or press the **Mode** key to return to the modulation selection mode.
- (4) **Press the Rate** softkey to set the FSK rate. The rate at which the output frequency shifts between the carrier frequency and the hop frequency is determined by FSK rate. The range is 2 mHz – 1 MHz.
- (5) **Set hop frequency:**
Press the **Hop Freq** softkey to set the hop frequency. The carrier wave frequency shifts to the hop frequency with the specified FSK rate, and then returns to the original frequency.

3FSK (3 Frequency Shift Keying)

3 Frequency Shift Keying modulation is a modulation technique that shifts the output signal frequency among three preset frequencies: the carrier frequency

and two hop frequencies. The shift frequency (3FSK rate) is determined by the internal signal level of the instrument. The 3FSK user interface is shown below.

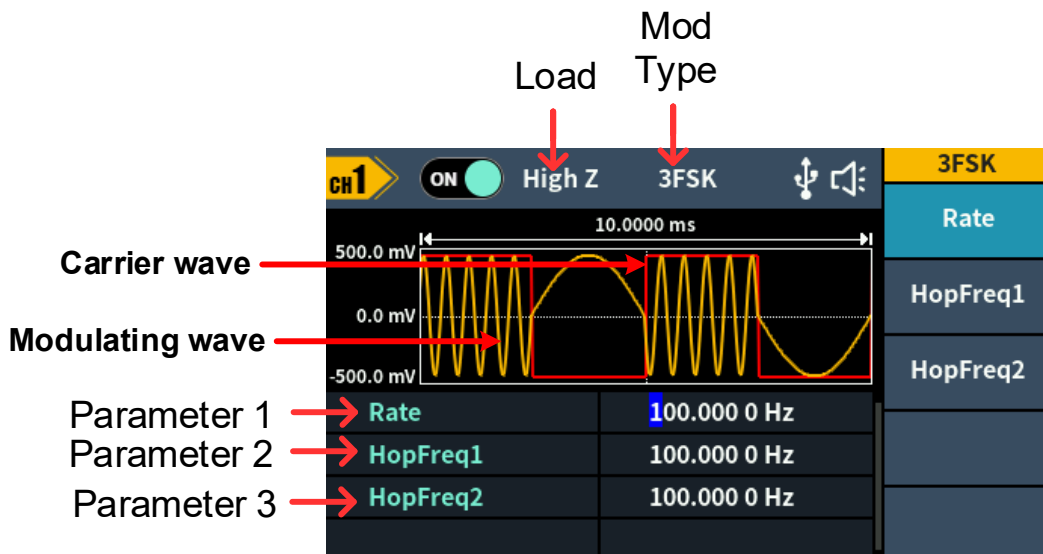





Figure 5-22: 3FSK user interface

How to set the parameters of 3FSK

- (1) Press the **Mode** function key, press the **NextPage** softkey twice more, then press the **3FSK** softkey to enter 3FSK user interface.
- (2) **Select carrier wave shape:**
The carrier wave can be **Sine**, **Square**, **Ramp**, or **Arbitrary** wave (except DC). Press , , , or  to select a desired carrier wave shape.
- (3) **Set carrier wave parameters:**
Press **the wave shape key** of the selected carrier wave to display the waveform and parameters of the carrier wave. You can change the parameters of the carrier wave. Press the corresponding carrier waveform key to return to the modulation mode interface or press the **Mode** key to return to the modulation selection mode.
- (4) **Modulating wave source:**
3FSK uses internal modulation source, and the modulating wave is set as a Square with 50% duty cycle.
- (5) **Set 3FSK rate:**
Press the **Rate** softkey to set the 3FSK rate. The rate at which the output frequency shifts between the carrier frequency and the two hop frequencies is determined by 3FSK rate (for internal source). The range is 2 mHz – 1 MHz.

(6) Set hop frequencies:

Press the **HopFreq1** and **HopFreq2** softkey to set the two hop frequencies.

4FSK (4 Frequency Shift Keying)

4 Frequency Shift Keying modulation is a modulation technique that shifts the output signal frequency among four preset frequencies: the carrier frequency and three hop frequencies. The shift frequency (4FSK rate) is determined by the internal signal level of the instrument. The 4FSK user interface is shown below.

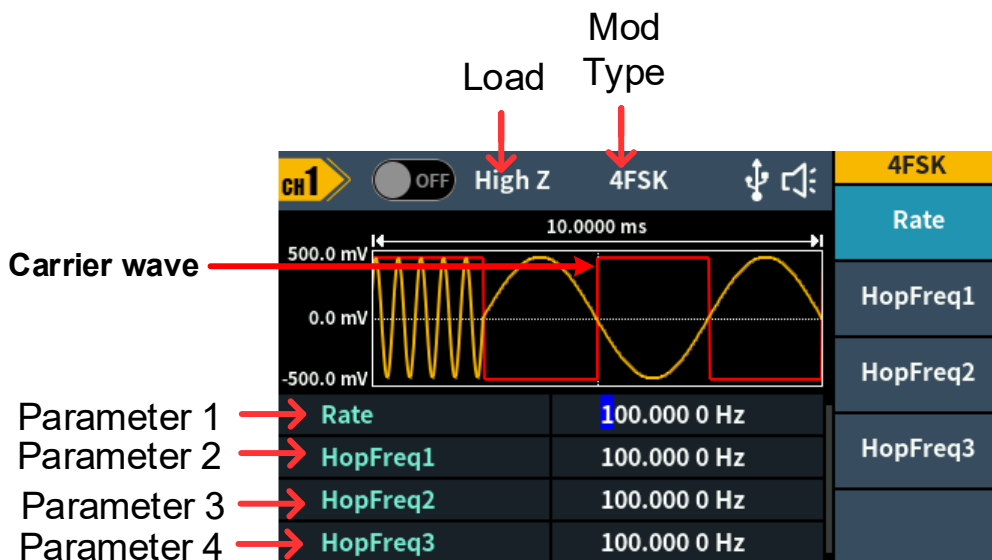





Figure 5-23: 4FSK user interface

How to set the parameters of 4FSK

- (1) Press the **Mode** function key, press the **NextPage** softkey twice more, then press the **4FSK** softkey to enter 4FSK user interface.
- (2) **Select carrier wave shape:**
The carrier wave can be **Sine**, **Square**, **Ramp**, or **Arbitrary** wave (except DC). Press , , , or  to select a desired carrier wave shape.
- (3) **Set carrier wave parameters:**
Press the **wave shape key** of the selected carrier wave to display the waveform and parameters of the carrier wave. You can change the parameters of the carrier wave. Press the corresponding carrier waveform key to return to the modulation mode interface or press the **Mode** key to return to the modulation selection mode.
- (4) **Modulating wave source:**

4FSK uses internal modulation source, and the modulating wave is set as a Square with 50% duty cycle.

(5) Set 4FSK rate:

Press the **Rate** softkey to set the 4FSK rate. The rate at which the output frequency shifts between the carrier frequency and the three hop frequencies is determined by 4FSK rate (for internal source). The range is 2 mHz – 1 MHz.

(6) Set hop frequencies:

Press the **HopFreq1**, **HopFreq2** and **HopFreq3** softkey to set the three hop frequencies.

BPSK (Binary Phase Shift Keying)

Binary Phase Shift Keying modulation is a modulation technique that shifts the output signal phase between two phases: the carrier phase and modulating phase. Carrier wave phase shifts to the modulating phase with the specified BPSK rate, and then returns to the original phase. The BPSK user interface is shown below.

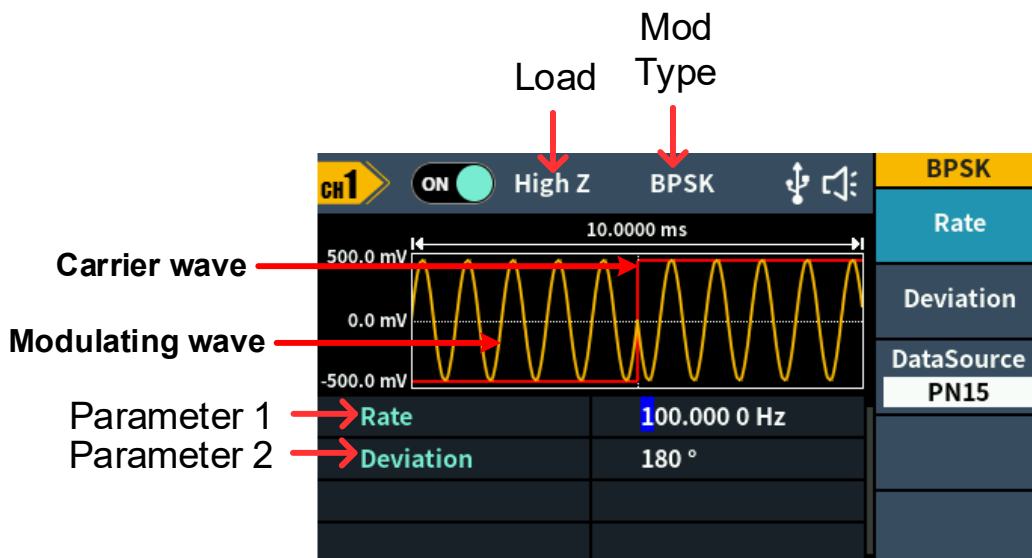





Figure 5-24: BPSK user interface

How to set the parameters of BPSK

(1) Press the **Mode** function key, press the **NextPage** softkey three more times, then press the **BPSK** softkey to enter BPSK user interface.

(2) Select carrier wave shape:

The carrier wave can be **Sine**, **Square**, **Ramp**, or **Arbitrary** wave (except DC). Press , , , or  to select a desired carrier wave shape.

(3) Set carrier wave parameters:

Press **the wave shape key** of the selected carrier wave to display the waveform and parameters of the carrier wave. You can change the parameters of the carrier wave. Press the corresponding carrier waveform key to return to the modulation mode interface or press the **Mode** key to return to the modulation selection mode.

(4) Set BPSK rate:

Press the **Rate** softkey to set the BPSK rate. The rate at which the output phase shifts between the carrier phase and the modulating phase is determined by BPSK rate (for internal source). The range is 2 mHz – 1 MHz.

(5) Set BPSK phase deviation:

Press the **Deviation** softkey to set the modulating phase deviation.

Select modulating wave source:

BPSK uses internal modulation source. Press the **DataSource** softkey to select PN15, PN21, 01 Patt, or 10 Patt as the modulating wave source.

QPSK (Quadrature Phase Shift Keying)

Quadrature Phase Shift Keying modulation is a modulation technique that shifts the output signal phase among four preset phases: the carrier phase and three modulating phases. The shift frequency (QPSK rate) is determined by the internal signal level of the instrument. The QPSK user interface is shown below.

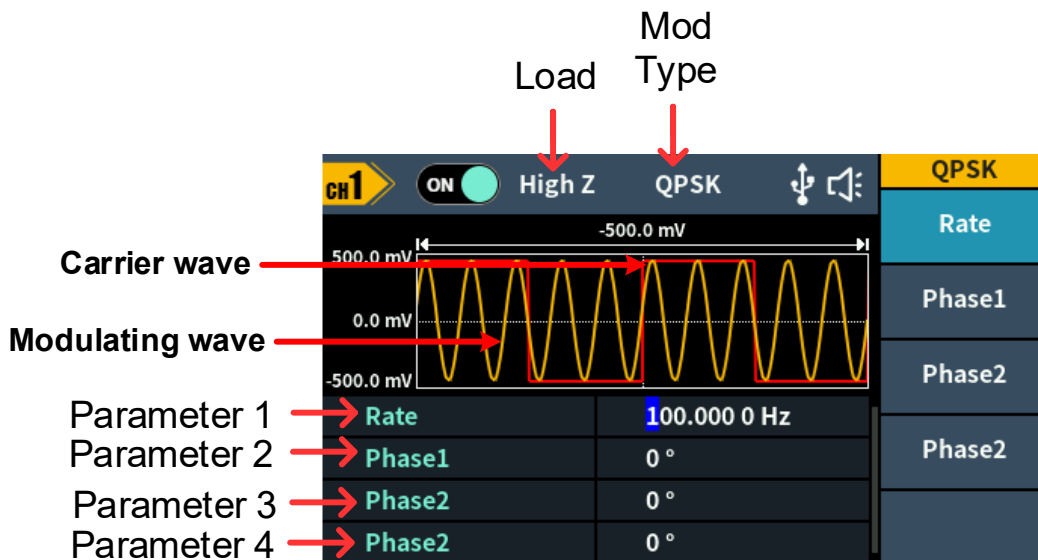

Figure 5-25: QPSK user interface

How to set the parameters of QPSK

- (1) Press the **Mode** function key, press the **NextPage** softkey three more times, then press the **QPSK** softkey to enter QPSK user interface.

(2) Select carrier wave shape:

The carrier wave can be **Sine**, **Square**, **Ramp**, or **Arbitrary** wave (except DC). Press , , , or  to select a desired carrier wave shape.

(3) Set carrier wave parameters:

Press the **wave shape key** of the selected carrier wave to display the waveform and parameters of the carrier wave. You can change the parameters of the carrier wave. Press the corresponding carrier waveform key to return to the modulation mode interface or press the **Mode** key to return to the modulation selection mode.

(4) Set QPSK rate:

Press the **Rate** softkey to set the QPSK rate. The rate at which the output phase shifts between the carrier phase and the modulating phase is determined by QPSK rate (for internal source). The range is 2 mHz – 100 kHz.

(5) Set the modulating phases:

Press the **Phase1**, **Phase2** and **Phase3** softkey to set the modulating phases respectively. The range is 0° to 360°.

OSK (Oscillation Shift Keying)

Oscillation Shift Keying modulation is a modulation technique that the generator to output a sine signal with intermittent oscillation. The start-oscillation and stop-oscillation of the internal crystal oscillator are controlled by the internal signal level of the instrument. When the internal crystal oscillator starts to oscillate, the instrument starts to output the carrier waveform and when the internal crystal stops oscillating, the output stops. The OSK user interface is shown below.

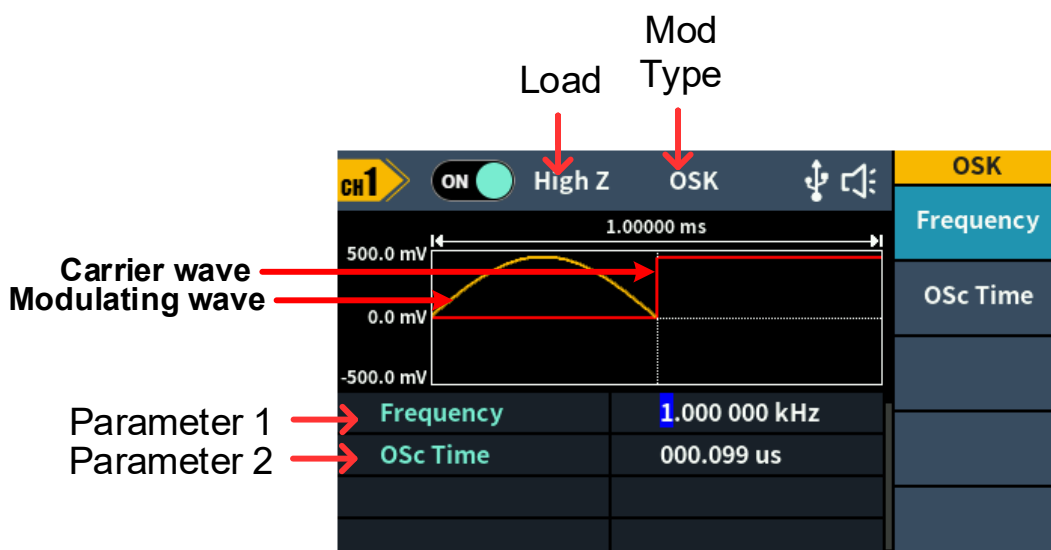



Figure 5-26: OSK user interface

How to set the parameters of OSK

(1) Set carrier wave shape:

OSK carrier wave can only be sine wave. Press  to set the carrier wave shape.

(2) Press the **Mode function key, press the **NextPage** softkey three more times, then press the **OSK** softkey to enter OSK user interface.**

Note: If **Sine** wave has not been selected, **OSK** in the menu is unavailable.

(3) Set carrier wave parameters:

Press  to display the waveform and parameters of the carrier wave. You can change the parameters of the carrier wave. Press the corresponding carrier waveform key to return to the modulation mode interface or press the **Mode** key to return to the modulation selection mode.

(4) Select modulating wave source:

OSK uses internal modulation source, and the modulating wave is set as a Square with 50% duty cycle.

(5) Set OSK rate:

Press the **Frequency** softkey to set the OSK rate. The intermittence time and oscillate time of the output signal is determined by OSK rate (for internal source). The range is 2 mHz – 100 kHz.

(6) Set oscillate time:

Oscillate time is the oscillation period of internal crystal oscillator. The settable range of the oscillate period is related to the OSK rate currently selected. Press the **Osc Time** softkey to set the oscillate time. The range is 8ns - 250s.

SUM (Sum Modulation)

The modulated waveform consists of the carrier wave and the modulating wave. For SUM, the amplitude of the carrier wave varies with the instantaneous voltage of the modulating wave. The SUM user interface is shown below.

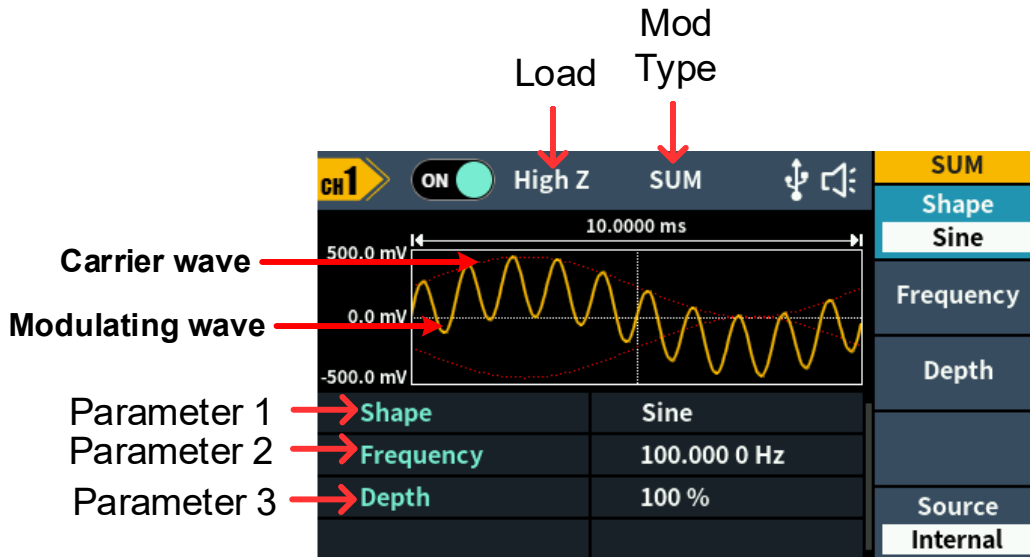





Figure 5-27: SUM user interface

How to set the parameters of SUM

- (1) Press the **Mode** function key, press the **NextPage** softkey three more times, then press the **SUM** softkey to enter SUM user interface.
- (2) **Select carrier wave shape:**
The carrier wave can be **Sine**, **Square**, or **Ramp**. Press , , or  to select a desired carrier wave shape.
- (3) **Set carrier wave parameters:**
Press the **wave shape key** of the selected carrier wave to display the waveform and parameters of the carrier wave. You can change the parameters of the carrier wave. Press the corresponding carrier waveform key to return to the modulation mode interface or press the **Mode** key to return to the modulation selection mode.
- (4) **Select modulating wave source:**
Press the **Source** softkey to select the modulating wave source.
If you select **External**, use the **Sync/Ext Mod/Trig/FSK** connector at the rear panel to input the external modulating signal, the SUM setting is completed.
If you select **Internal**, continue with the following steps.
- (5) **Select modulating wave shape:**
Press the **Shape** softkey, then press the **Sine**, **Square**, **Ramp** softkey to select the modulating wave.
- (6) **Set modulating wave frequency:**
Press the **Frequency** softkey to set the modulating wave frequency. The range is 2 mHz – 100kHz (for internal source only).

(7) Set modulation depth:

Press the **Depth** softkey to set the modulation depth. The range is 0% - 100%.

Utility Function Setting

Press the front panel **Utility** function key to enter the utility menu. You can set the parameters of the generator such as: display settings, CH1/2 settings, and system settings. Press **Utility** again to exit the utility menu.

Display Settings

Brightness Control

- (1) Press the front panel **Utility** function key, press the **Display** softkey.
- (2) Press the **Backlight** softkey to select **Backlight**.
- (3) Turn the **knob** to adjust the value on the current cursor, use the **←/→** direction key to move cursor left or right, or use the **numeric keypad** to enter the parameter and then select % as unit. The range is from 0% to 100%.

Screen Saver

If there is no operation within the set screen saver time, the screen enters the protection mode (minimize screen brightness to protect the screen and save energy). Press any key (except the power button) to restore the brightness before entering the screen saver.

- (1) Press the front panel **Utility** function key, press the **Display** softkey.
- (2) Press the **ScrSaver** softkey to select **On** or **Off**.
- (3) At **On** status, you can set the screen saver time. Turn the **knob** to adjust the value on the current cursor, use the **←/→** direction key to move cursor left or right, or use the **numeric keypad** to enter the parameter and then select Minute as unit. The screen saver time range is 1 to 999 minutes.

Separator

The user can set the separator of the screen display data.

- (1) Press the front panel **Utility** function key, press the **Display** softkey.
- (2) Press the **Separator** softkey to toggle between **Comma**, **Space**, and **Nothing**.

Taking the frequency parameter as an example:

Comma	1.000,000,000
Space	1.000 000 000
Nothing	1.000000000

CH1/2 Settings

Load

For either of **Out1** and **Out2** connector at the front panel, the generator has a 50Ω fixed serial output impedance. If the actual load does not match the specified value, the voltage level displayed would not match the voltage level of the component under test. This function is used to match the displayed voltage with the expected one.

The step to set the CH1 or CH2 load value is as follows:

- (1) Press the **Utility** function key, press the **CH1/2 Set** softkey.
- (2) Press the **CH1 Load** or **CH2 Load** softkey, press it again to select **High Z** or * **ohm** ("*" represents a value, the default is 50Ω).
- (3) To change the load value, after selecting * **ohm**, turn the **knob** to adjust the value on the current cursor, use the **←/→** direction key to move cursor left or right, or use the **numeric keypad** to enter the parameter and then select unit. The load range is 1Ω to 10k Ω.

Warning: Setup the correct load for right application.

Sync

The generator can output the sync signals of basic waveforms (except noise), arbitrary waveforms (except DC), sweep signal, burst signal, and modulated signal from a single channel or two channels at the same time.

The steps to enable or disable sync signal at the **Sync/Ext Mod/Trig/FSK** connector:

- (1) Press the **Utility** function key, press the **CH1/2 Set** softkey.
- (2) Press the **Sync** softkey, press the softkey to select **CH1,CH2** and **Off**.
When the sync signal select **Ch1** or **CH2**, which sends the sync signal to the **Sync** connector. When the sync signal is **Off**, the output level at the **Sync** connector is logic low(The sync signal default is **Off**) .

Sync signals of various waveforms

- For sine, square, ramp and pulse waves, the sync signal is a square wave with a 50% duty cycle. When the waveform output is positive, the sync signal is TTL high with respect to the 0V voltage (or DC offset

value). When the waveform output is negative, the sync signal is TTL low relative to the 0V voltage (or DC offset value).

- For arbitrary waveform, the sync signal is a square wave with a variable duty cycle. When the output waveform amplitude reaches a certain value, the sync signal is TTL high.
- For AM, FM, PM, and PWM, for internal modulation, the sync signal is referenced to the modulation frequency, and the sync signal is a square wave with a 50% duty cycle. In the first half of the modulation waveform, the sync signal is TTL high. When external modulation is performed, there is no sync signal output.
- For ASK, FSK, PSK, BPSK, QPSK, 3FSK, 4FSK, the synchronization signal is referenced to the keying frequency, and the synchronization signal is a square wave with a duty cycle of 50%. There is no sync signal output during external modulation.
- For OSK, the sync signal is referenced to the keyed frequency and the sync signal is a square wave with a 50% duty cycle. When the internal crystal oscillator starts, the sync signal is TTL high.
- For N-cycle bursts, the sync signal is TTL high at the beginning of the burst. At the end of the specified number of cycles, the sync signal is TTL low (if the waveform has an associated Phase, it may not be a zero crossing). For an infinite count pulse train, the sync signal is the same as the sync signal of the continuous waveform.
- For external gated bursts, the sync signal follows its gate signal. Note: This signal does not become TTL low until the end of the last cycle (if the waveform has an associated starting phase, it may not be a zero crossing).

Align Phase : Select **Align Phase** in the bottom menu to align the initial phase of two channel signals.

System Settings

Language

Only English supported.

Beeper

When the beeper is turned on, the beeper sounds when users operate the front panel or when an error occurs.

- (1) Press the front panel **Utility** function key, press the **System** softkey.
- (2) Press the **Beeper** softkey to toggle between **On** or **Off**.

USB Device Type

The user can set the communication protocol type of the USB Device interface at the rear panel.

- (1) Press the front panel **Utility** function key.
- (2) Press the **USB Dev** softkey to toggle between **PC** and **USBTMC**.
 - **PC**: This is the internal communication protocol. Select this option when connecting to the Waveform Editor software via the USB Device interface.
 - **USBTMC**: Select this option when you need to use the USBTMC communication protocol standard.

Restore to the factory setting

- (1) Press the front panel **Utility** function key, select **System** softkey, then press the **NextPage** softkey.
- (2) Press the **Factory Set** softkey, and then press the **OK** softkey to restore the generator to the factory default settings.

Table 5-1: The factory default settings

Output Configuration	Factory Setting
CH1 signal output switch	Off
CH2 signal output switch	Off
Function	Sine
Frequency	1 kHz
Amplitude/Offset	1 Vpp / 0 mV
Basic Waveform	Factory Setting
Frequency	1 kHz
Period	1 ms
Amplitude	1 Vpp
Offset	0 V
High Level	500 mV
Low Level	-500 mV
Phase	0°
Ramp Wave Symmetry	50%
Pulse Width	200 us
Pulse Duty Cycle	20%

5. Panel Operation

Pulse Rising Time	1.953 us
Pulse Falling Time	1.953 us
Build-in Wave	X ²
Modulation Waveform	Factory Setting
Modulation type	AM
AM	
Modulating Waveform	Sine
AM Frequency	100 Hz
Modulation Depth	100%
Modulation Source	Internal
FM	
Modulating Waveform	Sine
FM Frequency	100 Hz
Frequency Deviation	100 Hz
Modulation Source	Internal
PM	
Modulating Waveform	Sine
PM Frequency	100 Hz
Phase Deviation	0°
Modulation Source	Internal
PWM	
Modulating Waveform	Sine
PWM Frequency	100 Hz
Duty Cycle Deviation	0%
Modulation Source	Internal
ASK	
ASK Rate	100 Hz
Modulating Amplitude	1 V _{pp}
Modulation Source	Internal
PSK	
PSK Rate	100 Hz
PSK Phase Deviation	0°
Modulation Source	Internal
FSK	

5. Panel Operation

FSK Rate	100 Hz
Hop Frequency	100 Hz
Modulation Source	Internal
3FSK	
FSK Rate	100 Hz
Hop Frequency 1	100 Hz
Hop Frequency 2	100 Hz
4FSK	
FSK Rate	100 Hz
Hop Frequency 1	100 Hz
Hop Frequency 2	100 Hz
Hop Frequency 3	100 Hz
BPSK	
Bit Rate	100 Hz
BPSK Phase Deviation	180°
Data Source	PN15
QPSK	
Rate	100 Hz
OSK	
OSK Rate	1 kHz
Oscillate Time	100 us
Sweep	Factory Setting
Sweep Time	1 s
Sweep Type	Linear
Start Frequency	100 Hz
Stop Frequency	1 kHz
Center Frequency	550 Hz
Frequency Span	900 Hz
Trigger Source	Internal
Burst	Factory Setting
Burst Period	1 s
Burst Mode	N_Cycle
Number of Cycles	1
Trigger Source	Internal

Slope	Positive
Counter	Factory Setting
High Frequency Reject	On
Utility	Factory Setting
Backlight	50%
Screen Saver	On
Screen Saver Time	30 min
Thousand Separator	Space
CH1 load	High Z
CH2 load	High Z
synchronization	Off
USB device	PC
Language	Factory Delivery Setting
Beeper	On

Firmware Update

Use the rear-panel USB port to update your instrument firmware using a USB memory device.

Caution: Updating your instrument firmware is a sensitive operation, to prevent damage to the instrument, do not power off the instrument or remove the USB memory device during the update process.

To update your instrument firmware, do the following:

1. Push the **Utility** button, press the **System** softkey, press **NextPage** to next page, press **Upgrade**, the instrument will have a prompt message.
2. Push the **OK** button, the external disk icon is displayed on the PC .
3. Visit the company's website on the PC and select the required instrument firmware upgrade package for the corresponding model. Download the " AG. upp " file in the firmware upgrade package to the PC, and copy the firmware to the external disk that is displayed.
4. Restart the device. After the device is powered on, the upgrade status is displayed.
5. After the upgrade, the instrument will shut down automatically.
6. Press the  button to power on the instrument. (Press **Utility** to check whether the version is the desired target version)

Counter

The frequency counter measures signals in the frequency range from 100 mHz to 200 MHz. The **Counter** connector on the rear panel is used by default to receive the frequency counter input signal. The frequency meter works from the start, unless the connector is set to an external clock input or clock output.

- (1) Press the front panel **Counter** function key to enter the frequency counter interface.
- (2) Connect the signal to be tested to the **Counter** connector on the rear panel.
- (3) Press the **HF Rejection** softkey to toggle On or Off high frequency rejection. High-frequency rejection can be used to filter high-frequency factors when measuring low-frequency signals, improving measurement accuracy. When measuring low frequency signals with a frequency less than 1 kHz, turn on high frequency rejection to filter out high frequency noise interference; turn off high frequency rejection when measuring high frequency signals with frequencies greater than 1 kHz.
- (4) The frequency, period and duty cycle can be viewed on the frequency meter interface.

6. Communication with PC

Supports communication with a computer via a USB port. Using the Waveform Editor software installed on the computer, the signal generator can be operated on the computer to control the output and write of the signal generator.

The instrument settings can be saved as files in internal memory. Up to 16 instrument settings can be saved in the instrument internal memory.

Note: Please go to our official website to obtain the Waveform Editor communication software and install it.

Set the USB device protocol type of the signal generator: Press **Utility** → **System** → **USB Dev**, switch to PC.

Connection: Connect the USB Device interface on the rear panel of the signal generator to the USB interface of the computer with a USB cable.

Install the driver: Run Waveform Editor software on the computer. Follow the instructions to install the driver. The path of the driver is the USBDRV folder in the directory where the Waveform Editor communication software is located, such as "C:\Program Files (x86)\DS_Wave\Waveform Editor\Driver".

Host computer communication port setting: Open the Waveform Editor software, click "Communications" in the menu bar, select "Ports-Settings", in the setting dialog box, select the communication port as "USB". After the connection is successful, the connection status prompt in the lower right corner of the software interface turns green.

7. Troubleshooting

1. The screen is still black and there is no display after you press the power switch, please follow the steps below:

- Check whether the power is connected correctly.
- Check whether the fuse below the power connector meets the specified type and rating and in good condition (the cover can be pried open with a flat-blade screwdriver).
- Restart the instrument after completing the above inspections.
- If the problem still exists, please contact us for our service.

2. The measured value of the output signal amplitude does not match the displayed value:

Check whether the actual load value of the signal is consistent with the load value set in the instrument. Please refer to CH1/2 Settings on page 46.

If you encounter other problems, please try to restart the instrument. If it still can not work properly, please contact us for our service.

8. Specification

All technical specifications are guaranteed when the following conditions are met, unless otherwise stated.

- The signal generator must be operated continuously for more than 30 minutes at the specified operating temperature (20°C to 30°C) to meet these specifications;
- The signal generator is in the calibration internal and has performed a self-calibration.

In addition to the specifications marked with the word "Typical", the specifications used are guaranteed.

Waveforms

Waveforms		
Bandwidth	FG-1302	30 MHz
	FG-1602	60 MHz
Sample Rate	FG-1302	125MSa/s
	FG-1602	300MSa/s
Vertical Resolution	14 bits	
Channel	2	
Standard Waveforms	Sine wave, square wave, ramp wave, pulse wave, noise	
Arbitrary Waveforms	Sinc, exponential rise, exponential decline, electrocardiogram, Gaussian, semi-positive, Lorentz, dual audio, DC voltage totaling more than 160 kinds	

Frequency Characteristics

Frequency Characteristics (Frequency resolution to 1 μ Hz)		
Sine wave	FG-1302	1 μ Hz ~ 30MHz
	FG-1602	1 μ Hz ~ 60MHz
Square wave	FG-1302	1 μ Hz ~ 15MHz
	FG-1602	1 μ Hz ~ 20MHz
Pulse wave	FG-1302	1 μ Hz ~ 15MHz
	FG-1602	1 μ Hz ~ 20MHz
Ramp wave	FG-1302	1 μ Hz ~ 1 MHz
	FG-1602	1 μ Hz ~ 2 MHz
Noise wave (-3 dB)	20 MHz BW (AWGN)	
Arbitrary wave	1 μ Hz - 10 MHz	
Frequency resolution	1 μ Hz or 7 significant figures	

7.Specification

Frequency stability	±30 ppm at 0±40°C
Frequency aging rate	±30 ppm per year

Amplitude Characteristics

Amplitude Characteristics (not specifically labeled, the load defaults to 50Ω)		
Output amplitude	FG-1302	2mVpp ~ 20Vpp (≤ 10MHz) High Z 2mVpp ~ 10Vpp (≤ 30MHz) High Z 1mVpp ~ 10Vpp (≤ 10MHz) 50 Ω 1mVpp ~ 5Vpp (≤ 30MHz) 50 Ω
	FG-1602	2mVpp ~ 20Vpp (≤ 10MHz) High Z 2mVpp ~ 10Vpp (≤ 60MHz) High Z 1mVpp ~ 10Vpp (≤ 10MHz) 50 Ω 1mVpp ~ 5Vpp (≤ 60MHz) 50 Ω
Amplitude accuracy	± (1% of setting + 1 mVpp) (Typical 1kHz sine, 0V offset)	
Amplitude resolution	1mVpp or 4 digits	
DC offset range (AC +DC)	FG-1302	±(10 Vpk–Amplitude Vpp/2) High Z (≤ 10MHz) ±(5Vpk - Amplitude Vpp/2) High Z (≤ 30MHz) ±(5 Vpk – Amplitude Vpp/2) 50Ω (≤ 10MHz) ±(2.5 Vpk – Amplitude Vpp/2) 50Ω (≤ 30MHz)
	FG-1602	±(10Vpk – Amplitude Vpp/2) High Z (≤ 10MHz) ±(5Vpk–Amplitude Vpp/2) High Z (≤ 60MHz) ±(5 Vpk - Amplitude Vpp/2) 50Ω (≤ 10MHz) ±(2.5 Vpk– Amplitude Vpp/2) 50Ω (≤ 60MHz)
	Note: Offset > 2.5Vpp, amplitude ≥10mV (High Z) Offset > 1.25Vpp, amplitude ≥5mV (50Ω)	
DC offset accuracy	± (1 % of setting + 1 mV + amplitude Vpp * 0.5%)	
Offset resolution	1 mVpp or 4 digits	
Output Impedance	50Ω (Typical)	

Signal Characteristics

Signal Characteristics		
Sine		
Bandwidth flatness (relative to 1 kHz Sine wave, 1 Vpp)	FG-1302	≤10MHz: ±0.3dB ≤30MHz: ±0.5dB
	FG-1602	≤10MHz: ±0.3dB ≤35MHz: ±0.5dB ≤60MHz: ±1dB
Harmonic distortion	FG-1302	Typical (0dBm) DC to 1MHz: <-65dBc 1MHz to 30MHz: <-60dBc

7.Specification

	FG-1602	Typical (0dBm) DC to 1MHz: <-65dBc 1MHz to 35MHz: <-60dBc 35MHz to 60MHz: <-50dBc
Total harmonic distortion	< 0.2 %, 10 Hz to 20 kHz, 1 Vpp	
Non-harmonic distortion	Typical (0dBm) ≤10MHz: <-70dBc >10MHz: <-70dBc + 6dB/ sound interval	
Phase noise	Typical (0dBm, 10kHz offset) 10MHz: ≤ -110dBc/Hz	
Square		
Rise/fall time	< 20ns	
Jitter (rms), typical (1Vpp, 50Ω)	200ps + 30ppm	
Overshoot	< 5%	
Ramp		
Linearity	< 1% of peak output (typical 1 kHz, 1 Vpp, symmetry 50%)	
Symmetry	0% to 100%	
Pulse		
Period	FG-1302	67 ns to 1 Ms
	FG-1602	50 ns to 1 Ms
Pulse Width	≥ 24ns	
Rise and fall time	≥ 15ns	
Overshoot	< 5%	
Jitter (rms), typical (1Vpp, 50Ω)	200ps + 30ppm	
Noise		
Types	Gaussian white noise	
Bandwidth (-3dB)	20 M	
Arbitrary wave		
Bandwidth	10M	
Waveform length	2 to 100K points	
Sampling rate	FG-1302	125Ma/s
	FG-1602	300Ma/s
Amplitude accuracy	14 bits	

Modulation Characteristics

Modulation Characteristics	
Modulation Type	AM, DSBAM, FM, PM, ASK, FSK, PSK, BPSK, QPSK, 3FSK, 4FSK, OSK, PWM, SUM

7.Specification

AM	
Carrier	Sine wave, square wave, ramp wave, arbitrary wave (except DC)
Modulated signal source	Internal or external
Internal modulation waveform	Sine wave, square wave, ramp wave, white noise
Internal amplitude modulation frequency	2 mHz to 100 kHz
Depth	0% to 100%
DSBAM	
Carrier	Sine wave, square wave, ramp wave, arbitrary wave (except DC)
Modulated signal source	Internal or external
Internal modulation waveform	Sine wave, square wave, ramp wave
Internal amplitude modulation frequency	2 mHz to 100 kHz
Depth	0% to 100%
FM	
Carrier	Sine wave, square wave, ramp wave, arbitrary wave (except DC)
Modulated signal source	Internal or external
Internal modulation waveform	Sine wave, square wave, ramp wave, white noise
Internal modulation frequency	2 mHz to 100 kHz
Frequency offset	1 μ Hz to carrier frequency
PM	
Carrier	Sine wave, square wave, ramp wave, arbitrary wave (except DC)
Modulated signal source	Internal or external
Internal modulation waveform	Sine wave, square wave, ramp wave, white noise
Internal phase modulation frequency	2 mHz to 100 kHz
Phase deviation range	0° to 180°
PWM	
Carrier	Pulse wave
Modulated signal source	Internal or external
Internal modulation waveform	Sine wave, square wave, ramp wave, white noise

7.Specification

Internal phase modulation frequency	2 mHz to 1 MHz
Offset	0% to Carrier pulse duty cycle
ASK	
Carrier	Sine wave, square wave, ramp wave, arbitrary wave (except DC)
Modulated signal source	Internal or external
Internal modulation waveform	50% square wave
Internal modulation amplitude	0m Vpp to carrier amplitude
ASK frequency	2 mHz to 1MHz
PSK	
Carrier	Sine wave, square wave, ramp wave, arbitrary wave (except DC)
Modulated signal source	Internal or external
Internal modulation waveform	50% square wave
PSK frequency	2 mHz to 1MHz
Phase deviation range	0°to 360°
FSK	
Carrier	Sine wave, square wave, ramp wave, arbitrary wave (except DC)
Modulated signal source	Internal or external
Internal modulation waveform	50% square wave
FSK rate	2 mHz to 1MHz
FSK hopfreq	2 mHz to maximum frequency of corresponding carrier
3FSK	
Carrier	Sine wave, square wave, ramp wave, arbitrary wave (except DC)
Modulated signal source	Internal
Internal modulation waveform	50% square wave
FSK rate	2 mHz to 1MHz
4FSK	
Carrier	Sine wave, square wave, ramp wave, arbitrary wave (except DC)
Modulated signal source	Internal
Internal modulation waveform	50% square wave
FSK rate	2 mHz to 1MHz

7.Specification

BPSK	
Carrier	Sine wave, square wave, ramp wave, arbitrary wave (except DC)
Modulated signal source	Internal
Internal modulation waveform	50% square wave
BPSK rate	2 mHz to 1MHz
Phase deviation range	0°~360°
Data source	01patt, 10 patt, PN15, PN21
QPSK	
Carrier	Sine wave, square wave, ramp wave, arbitrary wave (except DC)
Modulated signal source	Internal
QPSK frequency	2 mHz to 1MHz
OSK	
Carrier	Sine wave
Modulated signal source	Internal
Internal modulation waveform	50% square wave
Oscillation time	8ns to 250s
OSK frequency	2 mHz to 100kHz
SUM	
Carrier	Sine wave, square wave, ramp wave, arbitrary wave (except DC)
Modulated signal source	Internal or external
Internal amplitude modulation frequency	2 mHz to 100kHz
Depth	0% to 100%

Sweep Characteristics

Sweep Characteristics	
Carrier	Sine, square wave, ramp wave, arbitrary wave (Except DC)
Minimum/maximum starting frequency	1 μHz (minimum) / maximum frequency of corresponding carrier
Minimum/maximum termination frequency	1 μHz (minimum) / maximum frequency of corresponding carrier
Types	Linear, logarithmic
Sweep time	1 ms to 500 s ± 0.1%
Trigger source	Internal, external, manual

Burst Characteristics

Burst Characteristics		
Waveform	Sine wave, square wave, ramp wave, pulse wave and arbitrary wave (Except DC)	
Types	N-cycle,Gated	
N-cycle trigger source	Internal, external, manual	
Carrier frequency	1 μ Hz to Maximum frequency of corresponding carrier /2	
N-cycle trigger cycle	FG-1302	67 ns ~ 1 Ms (Min = Cycles * Period)
	FG-1602	34 ns ~ 1 Ms (Min = Cycles * Period)
periodicity	1 ~ 60000 (Max =Burst Period / Period) /infinite	
Gated source	External trigger	

Counter Specifications

Counter Specifications	
Measurement function	Frequency, period
Frequency Range	Single channel :100 mHz - 200 MHz
Frequency resolution	6 digits
Input resistance	1 M Ω

Input/Output Characteristics

Input/Output Characteristics	
Communication Interface	USB Host, USB Device
External modulation input	
Input frequency range	DC - 20 kHz
Input level range	\pm 1V full scale
Input impedance	10 k Ω (typical)
External trigger input	
Level	TTL-compatible
Slope	Rising or falling (selectable)
Pulse Width	>100ns
Sync Output	
Level	TTL-compatible
Maximum frequency	1MHz

General Specifications

Display	
Display type	3.6-inch color LCD display
Display resolution	480 Horizontal \times 272 Vertical pixels

7.Specification

Display color	65536 colors, 16 bits, TFT
Power	
Voltage	100- 240 VAC, 50/60 Hz, CAT II
Power consumption	Less than 20W
Fuse	250V, F1AL
Environment	
Temperature	Working temperature: 0 °C to 40 °C
	Storage temperature: -20 °C to 60 °C
Relative humidity	Less than 35°C: ≤ 90% relative humidity 35°C to 40°C: ≤ 60% relative humidity
Height	Operating 3,000 meters Non-operation 12,000 meters
Mechanical Specification	
Dimension	200mm (Length) × 92.1 mm (Height) × 147.5mm (Width)
Weight	Approx. 0.8 kg
Others	
Adjustment interval	The recommended calibration interval is one year

9. Appendix

Appendix A: Accessories

- 1 × power cord that meets the standards of the country where you are located
- 1 × USB communication cable
- 1 × BNC/Q9 cable
- 1 × BNC to alligator cable
- 1 × extra fuse
- 1 × EN Quick Guide
- 1 × DE Quick Guide
- 1 × safety hintsheet
- 1 × CD ROM

Appendix B: General Care and Cleaning

General Maintenance

Do not store or leave the instrument where the liquid crystal display will be exposed to direct sunlight for long periods of time.

Caution: To avoid any damage to the instrument or probe, do not exposed it to any sprays, liquids, or solvents.

Cleaning

Inspect the instrument and probes as often as operating conditions require. To clean the instrument exterior, perform the following steps:

1. Wipe the dust from the instrument and probe surface with a soft cloth. Do not make any scuffing on the transparent LCD protection screen when clean the LCD screen.
2. Disconnect power before cleaning your instrument. Clean the instrument with a wet soft cloth not dripping water. It is recommended to scrub with soft detergent or fresh water. To avoid damage to the instrument or probe, do not use any corrosive chemical cleaning agent.



Warning: Before power on again for operation, it is required to confirm that the instrument has already been dried completely, avoiding any electrical short circuit or bodily injury resulting from the moisture.
