



Main

Accessory / separate part category	Cabling accessory
Accessory / separate part type	Pre-wired connectors
Series name	General purpose

Complementary

Electrical connection	M12, 5 pins (included earth pin) elbowed female connector
Cable connector fixing	Screw-on
Collar material	Metal
Status LED	Without
Cable length	5 m
Cable outer diameter	5.9 mm
Cable composition	5 x 0.34 mm ²
Wire insulation material	PUR
[Ue] rated operational voltage	60 V AC 75 V DC
[In] rated current	4 A
Contact resistance	5000 µOhm
Insulating resistance	1 GΩ
Product weight	0.27 kg

Environment

IP degree of protection	IP69K IP67 IP65
Product certifications	CULus
Ambient air temperature for operation	-40...80 °C (static) -5...80 °C (flexing)
Ambient air temperature for storage	-40...80 °C

Offer Sustainability

Sustainable offer status	Green Premium product
RoHS (date code: YYWW)	Compliant - since 0649 - Schneider Electric declaration of conformity Schneider Electric declaration of conformity
REACH	Reference not containing SVHC above the threshold
Product environmental profile	Available Product Environmental
Product end of life instructions	Available End Of Life Manual

Contractual warranty

Warranty period	18 months
-----------------	-----------

Dimensions

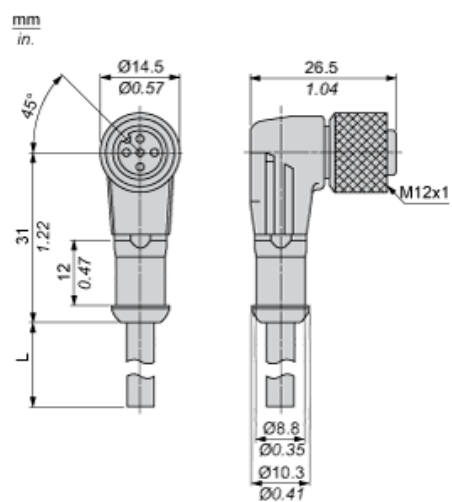

L : Length of cable

Connections and Schemes

Connectors

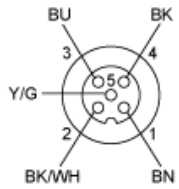

BU : Blue
BN : Brown
BK : Black
Y/G : Yellow / Green
BK/ Black / White
WH :