

RE17RMMW

time delay relay 10 functions - 1 s..100 h - 12..240 V
AC/DC - 1 OC



Main

| | |
|---------------------------|---|
| Range of product | Zelio Time |
| Product or component type | Modular timing relay |
| Discrete output type | Relay |
| Width | 17.5 mm |
| Device short name | RE17R |
| Time delay type | A Ac At B Bw C D Di H Ht |
| Time delay range | 0.1...1 s 1...10 h 1...10 min 1...10 s 10...100 h 6...60 min 6...60 s |
| Nominal output current | 8 A |

Complementary

| | |
|--------------------------------|--|
| Contacts type and composition | 1 C/O |
| Contacts material | Cadmium free |
| Control type | Selector switch on front panel |
| [Us] rated supply voltage | 12...240 V AC/DC at 50/60 Hz |
| Voltage range | 0.85...1.1 Us |
| Supply frequency | 50...60 Hz (+/- 5%) |
| Input voltage | 5 V |
| Connections - terminals | Screw terminals, clamping capacity: 1 x 0.5...1 x 3.3 mm ² AWG 20...AWG 12 (solid) without cable end Screw terminals, clamping capacity: 2 x 0.5...2 x 2.5 mm ² AWG 20...AWG 14 (solid) without cable end Screw terminals, clamping capacity: 1 x 0.2...1 x 2.5 mm ² AWG 24...AWG 14 (flexible) with cable end Screw terminals, clamping capacity: 2 x 0.2...2 x 1.5 mm ² AWG 24...AWG 16 (flexible) with cable end |
| Tightening torque | 0.6...1 N.m conforming to IEC 60947-1 |
| Housing material | Self-extinguishing |
| Repeat accuracy | +/- 0.5 % conforming to IEC 61812-1 |
| Temperature drift | +/- 0.05 %/°C |
| Voltage drift | +/- 0.2 %/V |
| Setting accuracy of time delay | +/- 10 % of full scale at 25 °C conforming to IEC 61812-1 |
| Impulse duration | 100 ms with load in parallel typical 30 ms typical |
| Insulation resistance | 100 MOhm at 500 V DC conforming to IEC 60664-1 |
| Reset time | 120 ms on de-energisation typical |
| On-load factor | 100 % |
| Power consumption in VA | 0...3 VA at 240 V AC |

The information provided in this documentation contains general descriptions and/or technical characteristics of the products contained herein. This documentation is not intended as a substitute for and is not to be used for determining suitability or reliability of these products for specific user applications. It is the duty of any such user or integrator to perform the appropriate and complete risk analysis, evaluation and testing of the products with respect to the relevant specific application or use thereof. Neither Schneider Electric Industries SAS nor any of its affiliates or subsidiaries shall be responsible or liable for misuse of the information contained herein.

| | |
|--|---|
| Power consumption in W | <= 1.5 W at 240 V DC |
| Minimum switching current | 10 mA at 5 V DC |
| Maximum switching current | 8 A AC/DC |
| Maximum switching voltage | 250 V AC |
| Breaking capacity | <= 2000 VA |
| Operating rate in Hz | 10 Hz |
| Electrical durability | 100000 cycles for resistive load (8 A at 250 V AC maximum) |
| Mechanical durability | 10000000 cycles |
| Dielectric strength | 2.5 kV 1 mA/1 minute 50 Hz conforming to IEC 61812-1 |
| [Uimp] rated impulse withstand voltage | 5 kV (1.2/50 µs) |
| Delay response | < 100 ms |
| Marking | CE |
| Creepage distance | 4 kV/3 conforming to IEC 60664-1 |
| Safety reliability data | MTTFd = 296.8 years B10d = 270000 |
| Mounting position | Any position in relation to normal vertical mounting plane |
| Mounting support | 35 mm DIN rail conforming to EN/IEC 60715 |
| Local signalling | LED indicator on steady: relay energised, no timing in progress LED indicator flashing: timing in progress (80 % ON and 20 % OFF) LED indicator pulsing: relay de-energised, no timing in progress (except function Di-D, Li-L) (5 % ON and 95 % OFF) |
| Product weight | 0.07 kg |

Environment

| | |
|---------------------------------------|--|
| immunity to microbreaks | <= 20 ms |
| standards | 2004/108/EC EN 61000-6-1 EN 61000-6-2 EN 61000-6-3 EN 61000-6-4 IEC 61812-1 2006/95/EC |
| product certifications | CSA CULus GL |
| ambient air temperature for storage | -30...60 °C |
| ambient air temperature for operation | -20...60 °C |
| IP degree of protection | IP20 (terminal block) conforming to IEC 60529 IP40 (housing) conforming to IEC 60529 IP50 (front panel) conforming to IEC 60529 |
| vibration resistance | 20 m/s ² (f = 10...150 Hz) conforming to IEC 60068-2-6 |
| shock resistance | 15 gn (duration = 11 ms) conforming to IEC 60068-2-27 |
| relative humidity | 93 % without condensation conforming to IEC 60068-2-30 |
| electromagnetic compatibility | Electrostatic discharge immunity test, in contact at 6 kV conforming to IEC 61000-4-2 level 3 Electrostatic discharge immunity test, in air at 8 kV conforming to IEC 61000-4-2 level 3 Susceptibility to electromagnetic fields, 80 MHz to 1 GHz at 10 V/m conforming to IEC 61000-4-3 level 3 Electrical fast transient/burst immunity test, capacitive connecting clip at 1 kV conforming to IEC 61000-4-4 level 3 Electrical fast transient/burst immunity test, direct at 2 kV conforming to IEC 61000-4-4 level 3 1.2/50 µs shock waves immunity test, differential mode at 1 kV conforming to IEC 61000-4-5 level 3 1.2/50 µs shock waves immunity test, common mode at 2 kV conforming to IEC 61000-4-5 level 3 Conducted RF disturbances, 0.15...80 MHz at 10 V conforming to IEC 61000-4-6 level 3 Voltage dips and interruptions immunity test, 1 cycle at 0 % conforming to IEC 61000-4-11 Voltage dips and interruptions immunity test, 25/30 cycles at 70 % conforming to IEC 61000-4-11 Conducted and radiated emissions conforming to EN 55022 class B |

Offer Sustainability

| | |
|----------------------------------|---|
| Sustainable offer status | Green Premium product |
| RoHS (date code: YYWW) | Compliant - since 1243 - Schneider Electric declaration of conformity |
| REACH | Reference not containing SVHC above the threshold |
| Product environmental profile | Available |
| Product end of life instructions | Available |

Width 17.5 mm

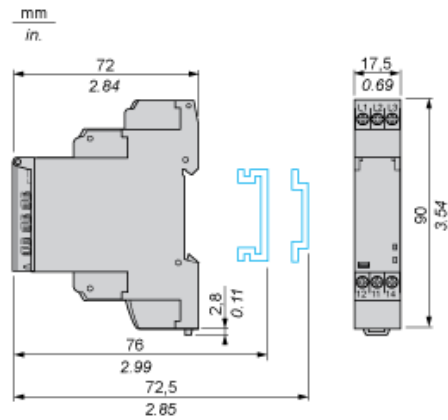

Internal Wiring Diagram

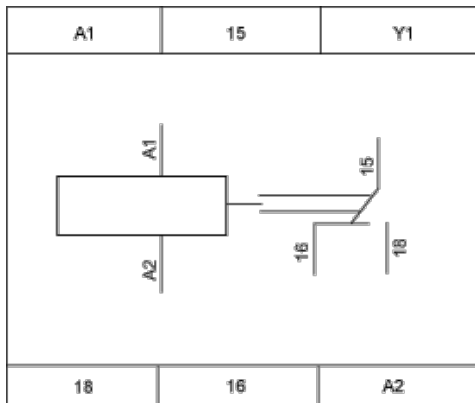

Wiring Diagram

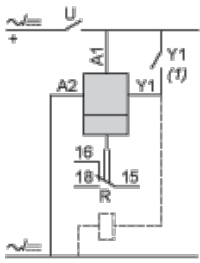

1) Contact Y1:

- | Control for functions B, C, Ac, Bw, Ad, Ah, N, O, W, T, Tt.
- | Partial stop for functions At, Ht and Pt.
- | Function D if Di selected.
- | Not used for functions A, H and P.

Function A : Power on Delay Relay

Description

The timing period T begins on energisation. After timing, the output(s) R close(s). The second output can be either timed or instantaneous.

Function: 1 Output



Function: 2 Outputs

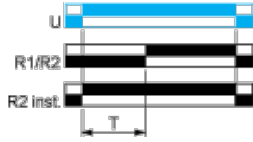

2 timed outputs (R1/R2) or 1 timed output (R1) and 1 instantaneous output (R2 inst.)

Function Ac : On- and Off-Delay Relay with Control Signal

Description

After power-up, closing of the control contact C causes the timing period T to start (timing can be interrupted by operating the Gate control contact G). At the end of this timing period, the relay closes.

When control contact C re-opens, the timing T starts.

At the end of this timing period T, the output reverts to its initial position (timing can be interrupted by operating the Gate control contact G).

The second output can be either timed or instantaneous.

Function: 1 Output

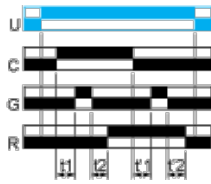

Function: 2 Outputs

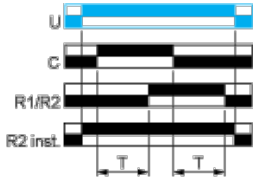

2 timed outputs (R1/R2) or 1 timed output (R1) and 1 instantaneous output (R2 inst.)

Function At : Power on Delay Relay (Summation) with Control Signal

Description

After power-up, the first opening of control contact C starts the timing. Timing can be interrupted each time control contact closes. When the cumulative total of time periods elapsed reaches the pre-set value T, the output relay closes.

Function: 1 Output

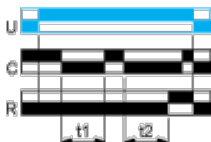

$T = t1 + t2 + \dots$

Function B : Interval Relay with Control Signal

Description

After power-up, pulsing or maintaining control contact C starts the timing T. The output R closes for the duration of the timing period T then reverts to its initial state.

Function: 1 Output



Function Bw : Double Interval Relay with Control Signal

Description

On closing and opening of control contact C, the output R closes for the duration of the timing period T.

Function: 1 Output



Function C : Off-Delay Relay with Control Signal

Description

After power-up and closing of the control contact C, the output R closes. When control contact C re-opens, timing T starts. At the end of the timing period, the output(s) R revert(s) to its/their initial state. The second output can be either timed or instantaneous.

Function: 1 Output

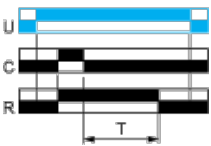

Function: 2 Outputs

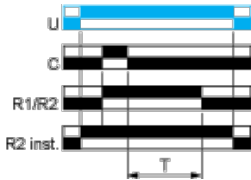

2 timed outputs (R1/R2) or 1 timed output (R1) and 1 instantaneous output (R2 inst.)

Function D : Symmetrical Flasher Relay (Starting Pulse Off)

Description

Repetitive cycle with two timing periods T of equal duration, with output(s) R changing state at the end of each timing period T. The second output can be either timed or instantaneous.

Function: 1 Output

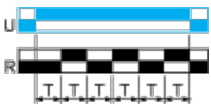

Function: 2 Outputs

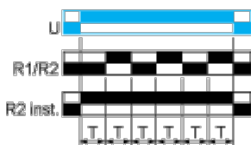

2 timed outputs (R1/R2) or 1 timed output (R1) and 1 instantaneous output (R2 inst.)

Function Di : Symmetrical Flasher Relay (Starting Pulse On)

Description

Repetitive cycle with two timing periods T of equal duration, with output(s) R changing state at the end of each timing period T. The second output can be either timed or instantaneous.

Function: 1 Output

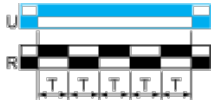

Function: 2 Outputs

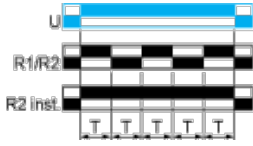

2 timed outputs (R1/R2) or 1 timed output (R1) and 1 instantaneous output (R2 inst.)

Function H : Interval Relay

Description

On energisation of the relay, timing period T starts and the output(s) R close(s). At the end of the timing period T, the output(s) R revert (s) to its/their initial state. The second output can be either timed or instantaneous.

Function: 1 Output



Function: 2 Outputs

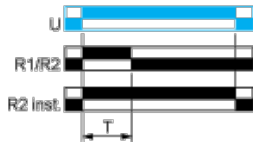

2 timed outputs (R1/R2) or 1 timed output (R1) and 1 instantaneous output (R2 inst.)

Function Ht : Interval Relay (Summation) with Control Signal

Description

On energisation, the output R closes for the duration of a timing period T then reverts to its initial state.

Pulsing or maintaining control contact C will again close the output R.

Timing T is only active when control contact C is released and so the output R will not revert to its initial state until after a time $t_1 + t_2 + \dots$

The relay memorises the total, cumulative opening time of control contact C and, once the set time T is reached, the output R reverts to its initial state.

Function: 1 Output



$T = t_1 + t_2 + \dots$

Legend

- Relay de-energised
- Relay energised
- Output open
- Output closed
- C** Control contact
- G** Gate

R Relay or solid state output

R1/R22 timed outputs

R2 The second output is instantaneous if the right position is selected
inst.

T Timing period

Ta - Adjustable On-delay

Tr - Adjustable Off-delay

U Supply