



DOBOT

User Guide

Dobot M1 User Guide

Issue: V1.2.1

Date: 2018-12-15

Shenzhen Yuejiang Technology Co.,

Copyright © ShenZhen Yuejiang Technology Co., Ltd 2018. All rights reserved.

No part of this document may be reproduced or transmitted in any form or by any means without prior written consent of Yuejiang Technology Co., Ltd

Disclaimer

To the maximum extent permitted by applicable law, the products described (including its hardware, software and firmware, etc.) in this document are provided **AS IS**, which may have flaws, errors or faults. Yuejiang makes no warranties of any kind, express or implied, including but not limited to, merchantability, satisfaction of quality, fitness for a particular purpose and non-infringement of third party rights. In no event will Yuejiang be liable for any special, incidental, consequential or indirect damages resulting from the use of our products and documents.

Before using our product, please thoroughly read and understand the contents of this document and related technical documents that are published online, to ensure that the robotic arm is used on the premise of fully understanding the robotic arm and related knowledge. Please use this document with technical guidance from professionals. Even if follow this document or any other related instructions, Damages or losses will be happen in the using process, Dobot shall not be considered as a guarantee regarding to all security information contained in this document.

The user has the responsibility to make sure following the relevant practical laws and regulations of the country, in order that there is no significant danger in the use of the robotic arm.

Certification specification

Dobot M1 has been certified as follows.



Shenzhen Yuejiang Technology Co., Ltd

Address: 3F, Building NO.3, Tongfuyu Industrial Town, Nanshan District, Shenzhen, China

Website: www.dobot.cc

Preface

Purpose

This Document describes the functions, technical specifications, installation guide and system commissioning of Dobot M1, making it easy for users to fully understand and use it.

Intended Audience

This document is intended for:



- Customer Engineer
- Sales Engineer
- Installation and Commissioning Engineer
- Technical Support Engineer



Change History

Date	Change Description
2018/12/15	The first release Add: <ul style="list-style-type: none"> • 6.8 Operating Collision Detection • 6.10.4 Example of TCP/IP Control • 6.10.5 Example of External Expansion I/O Control Modify <ul style="list-style-type: none"> • 4 Electrical Specifications: Modify the interface board appearance, CAN interface, external expansion board interface descriptions • 5 Installation and Commissioning: Modify the document structure, the installing procedure, and the way to connect PC to Dobot M1 • 6.9 Operating Web Management: Modify the GUI picture and the updating firmware procedure • 7.3.1 Encoder Battery Maintenance: Modify the related operations of Encoder battery • Modify the GUI picture in this document as the latest M1Studio Delete: 5.3.3 Setting IP address

Symbol Conventions

The symbols that may be founded in this document are defined as follows.

Symbol	Description
 DANGER	Indicates a hazard with a high level of risk which, if not avoided, could result in death or serious injury
 WARNING	Indicates a hazard with a medium level or low level of risk which, if not avoided, could result in minor or moderate injury, robotic arm damage

Symbol	Description
 NOTICE	Indicates a potentially hazardous situation which, if not avoided, can result in robotic arm damage, data loss, or unanticipated result
 NOTE	Provides additional information to emphasize or supplement important points in the main text

Contents

1. Security Precautions	1
1.1 General Security.....	1
1.2 Service Security	2
2. Introduction.....	4
2.1 Overview.....	4
2.2 Appearance and Constitute	4
2.3 Working Principle	5
2.3.1 Workspace	5
2.3.2 Coordinate System.....	5
2.3.3 Arm Orientation.....	7
2.3.4 Motion Function	8
2.4 Technical Specifications	12
2.4.1 Technical Parameters.....	12
2.4.2 Sizes.....	13
3. Hardware Installation	15
3.1 Environment Requirements	15
3.2 Installing the Base of Dobot M1	15
3.3 (Optional) Installing End Effector	16
3.3.1 Installing Laser Engraving Kit	16
3.3.2 Installing 3D Printing Kit	17
3.4 (Optional) Installing Air Pump	19
4. Electrical Specifications.....	22
4.1 Interface Board	22
4.2 LED Indicators.....	23
4.3 Interface Description.....	23
4.3.1 Power Adapter Interface	23
4.3.2 Body I/O Interface	24
4.3.3 External Expansion Interface.....	27
4.3.4 Communication Interface	31
5. Installation and Commissioning	32
5.1 Installing Software	32
5.1.1 Environment Requirements	32
5.1.2 Obtaining M1Studio Software Package.....	32
5.1.3 Installing M1Studio	32
5.1.4 Verifying Installation	34
5.1.5 Troubleshooting.....	34
5.2 Connecting Cables	34
5.2.1 Connecting Power Supply	34
5.2.2 Connecting Emergency Stop Switch	38
5.2.3 Connecting Serial Port.....	39
5.2.4 (Optional) Connecting Network Cable.....	41
5.3 System Commissioning	45

5.3.1	Debugging Dobot M1	45
5.3.2	Debugging the Power of Dobot M1	46
5.3.3	Debugging Emergency Stop Function.....	47
5.3.4	Debugging Disabling Function.....	48
5.3.5	Debugging Motion Function	49
5.3.6	Debugging Homing Function	51
6.	Operation	53
6.1	Instructions for M1Studio	53
6.1.1	Module Description	53
6.1.2	Alarms Description.....	53
6.1.3	Saving Point in ARC Mode	56
6.1.4	Saving point in JUMP Mode	58
6.2	Operating Teaching and Playback.....	58
6.2.1	Basic Operation	58
6.2.2	Other Function Description	62
6.3	Scripting.....	66
6.4	Operating Blockly	67
6.5	Operating Laser Engraving	69
6.6	Operating 3D Printing.....	72
6.7	Operating I/O Assistant.....	79
6.8	Operating Collision Detection	79
6.9	Operating Web Management.....	83
6.9.1	Managing Offline File	84
6.9.2	Upgrading Firmware	86
6.10	Example	90
6.10.1	Example of the Trajectory	90
6.10.2	Example of the External Drive	92
6.10.3	Example of Switching the Arm Orientation at the Same Point	93
6.10.4	Example of TCP/IP Control.....	94
6.10.5	Example of External Expansion I/O Control.....	101
7.	Maintenance	106
7.1	Routine Maintenance	106
7.1.1	Routine Inspection.....	106
7.1.2	Periodic Inspection	107
7.1.3	Cleaning Maintenance	108
7.2	Maintenance of Mechanical Parts.....	109
7.2.1	Greasing Screw Rod of Z-axis.....	109
7.2.2	Greasing Guide Rail of Z-axis.....	110
7.3	Maintenance of Electrical Parts	110
7.3.1	Encoder Battery Maintenance	111
7.3.2	Calibration	122

1. Security Precautions

This topic describes the security precautions that should be noticed when using this product. Please read this document carefully before using the robotic arm for the first time. This product need to be carried out in an environment meeting design specifications, you cannot remold the product without authorization, otherwise it could lead to product failure, and even personal injury, electric shock, fire, etc. People who use this product for system design and manufacture must be trained by our company, relevant institution, or must have the same professional skills. The installation personnel, operators, teaching personnel, programmers and system developers of the robotic arm must read this document carefully and use the robotic arm strictly according to the regulations of this document strictly.

1.1 General Security



Robotic arm is an electrical equipment. Non-professional technicians cannot modify the wire, otherwise it is vulnerable to injury the device or the person.

The following security rules should be followed when using the robotic arm for industrial design and manufacture.

- You should comply with local laws and regulations when operating the robotic arm. The security precautions in this document are only supplemental to local laws and regulations.
- The **DANGER**, **WARNING**, and **NOTICE** marks in this document are only supplemental to the security precautions.
- Please use the robotic arm in the specified environment scope. If not, exceeding the specifications and load conditions will shorten the service life of the product even damage the equipment.
- Please ensure that the robotic arm is operated under security conditions and there is no harmful object around the robotic arm.
- The hazardous area of the robotic arm is its workspace plus 100mm. In order to prevent people from entering the work area accidentally, it is necessary to build the safety barrier to prohibit people from entering the hazardous area.
- When the temperature is close to the freezing temperature, the other operations on the robotic arm will not be allowed until the robotic arm moves at the rate of 10% or less for more than ten minutes to make itself warm up.
- Highly corrosive cleaning is not suited to cleaning the robotic arm. The anodized components are not suitable for immersion cleaning.
- Please execute daily inspection and regular maintenance, replace the defective parts in time, in order to keep the equipment in working order.
- Please comply with the relevant laws to deal with the product which is scrapped, and protect the environment.

- People cannot repair and disassemble the robotic arm without professional training. If there is a problem with the robotic arm, please contact Dobot technical support engineer in time.
- Before operating and maintaining the robotic arm, the personnel responsible for the installation, operation and maintenance must be trained to understand the various security precautions and to master the correct methods of operation and maintenance.
- Only trained and trained personnel may commission and set up the robotic arm.
- Commissioning of the incomplete machine is prohibited until it has been installed in a machine and the whole machine complies with the provisions of the Machinery Directive (2006/42/EC).
- The robotic arm may only be operated with the associated standard equipment. Any other use of tools is deemed to be inaccurate use.
- Only authorized personnel who are instructed in work safety must work on the machine.
- Before the operation, please wear protective clothing, such as antistatic uniform, protective gloves and protective shoes.
- It is prohibited to modify or remove the nameplates, instructions, icons and marks on the robotic arm and the related equipment.

1.2 Service Security



It is necessary to shut off the power supply before installing the robotic arm, to prevent any electric shock or malfunction.

The following security rules should be followed when using the robotic arm for installing, teaching and programing.

- Be careful during the robotic arm carrying or installing. Please follow the instructions on the packing box to put down the robotic arm gently and place it correctly in direction of arrow.
- Before operating the robotic arm, please find and understand how to operate the emergency stop function, ensure that the robotic arm can be stopped in an emergency.
- You must connect the cables needed to the robotic arm first, and then power on the robotic arm.
- When operating the robotic arm over the PC, please do not reach out into the workspace of the robotic arm, otherwise it will be vulnerable to injury the device or the person.
- When the robotic arm is running, please do not plug in or out the power and communication cables at will.
- Before disconnecting the external equipment from the robotic arm, such as 3D mouse, please make sure that the robotic arm is completely powered off.
- When powering on robotic arm for the first time, please check Z-axis or J3 value from M1Studio. If the value is below 10mm, an alarm about limitation is generated and

meanwhile the red indicator on the base of robotic arm is on, which is a normal phenomenon. At that point, you need to click **J3+** under Joint coordinate system on the **M1Studio** page to jog robotic arm to the position where the J3 value is above 10mm, and then the alarm will be cleared.

- When powering on for the first time, please ensure that the emergency stop switch has been opened (The emergency stop button is bumped). Otherwise, the robotic arm will not work normally. If the emergency stop switch is not opened, please rotate the emergency stop button clockwise. The emergency stop button will be bumped when rotating to 45°.
- Please **DO NOT** connect power cable to Dobot M1 directly without power adapter. Otherwise, the machine will be damaged.

2. Introduction

2.1 Overview

Dobot Master 1st generation robotic arm (Dobot M1 for short) focuses on the light industrial market with great potential, and supports teaching, playback, script control, blockly graphic programming, laser engraving, 3D printing, vision identity and other functions, which is flexibly used in intelligent sorting, circuit board soldering and other automatic production lines, so that it can become the sword to solve practical problems for light industrial users, and can also become the platform to carry the imagination of the maker. Dobot M1 has the following characteristics.

- The integrated design of the driver and controller without external controller simplifies the process of the initial installation and deployment.
- The perfect calibration of servo motor, harmonic reducer and kinematic algorithm inside Dobot M1 bring out the best of strength and speed.
- The rated load is 1.5kg, and the repeatability is 0.02mm.
- Various I/O and communication interfaces are provided for secondary development.

2.2 Appearance and Constitute

Dobot M1 consists of base, Z axis, Rear Arm, Forearm and R axis. Figure 2.1 shows the appearance.



Figure 2.1 The appearance of Dobot M1

2.3 Working Principle

This topic describes the workspace, principle, size, and technical specifications of Dobot M1.

2.3.1 Workspace

Figure 2.2 shows the workspace.

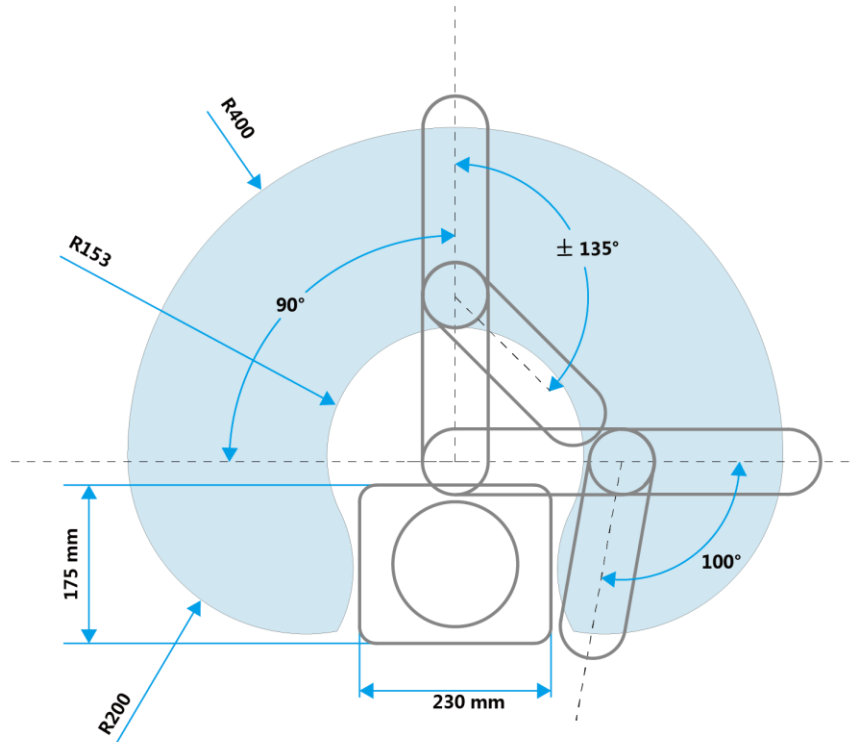

Figure 2.2 Workspace of Dobot M1

2.3.2 Coordinate System

Dobot M1 has two types of coordinate system, the joint one and the Cartesian one, as shown in Figure 2.3 and Figure 2.4 respectively.

 **NOTE**

The data shown in Figure 2.3 indicates the mechanical limitation.

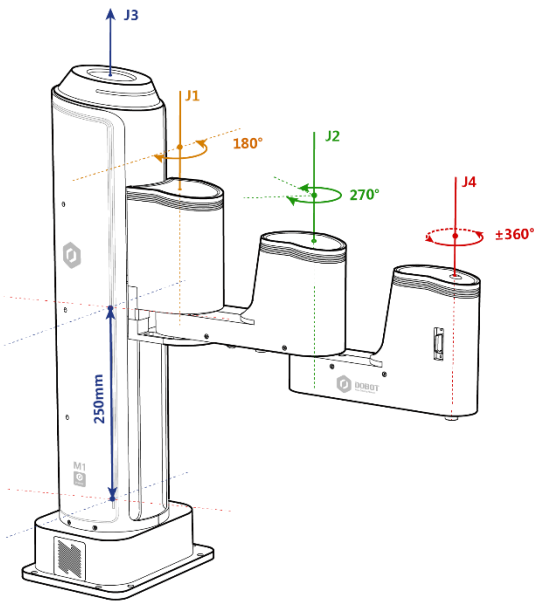

Figure 2.3 Joint coordinate system

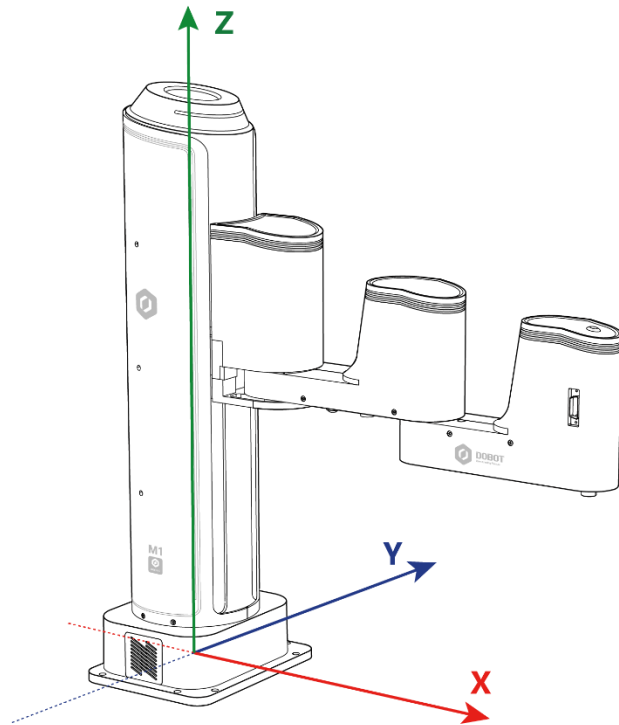

Figure 2.4 Cartesian coordinate system

- Joint coordinate system: The coordinates are determined by the motion joints.
Dobot M1 contains four joints.
 - J1, J2, and J4 are the rotating joints, which are located and oriented in the horizontal plane. And their axes are parallel to each other. The positive direction of these joints is counter-clockwise.
 - J3 is the moving joint, which is used for the movement of the end effector in the perpendicular plane. The positive direction of J3 is vertical upward.
- Cartesian coordinate system: The coordinates are determined by the base.
 - The origin is the axes center of the motor of Rear Arm where Rear Arm is dropped to the bottom of the Z-axis screw.
 - The direction of X-axis is perpendicular to the base forward.
 - The direction of Y-axis is perpendicular to the base leftward.
 - The direction of Z-axis is vertical upward, which is based on the right hand rule.
 - The R-axis is the attitude of the end center relative to the origin of the robotic arm, of which the positive direction is counter-clockwise. The R-coordinate is the sum of the coordinates of J1, J2 and J4.

2.3.3 Arm Orientation

With two types of arm orientation (lefty hand orientation and righty hand orientation), Dobot M1 can move to nearly any position and orientation within a given work envelope. You need to specify the arm orientation when Dobot M1 is moving. If you fail to do so, Dobot M1 may move following an unexpected path, resulting in interference with peripheral equipment. The arm orientations are shown as Figure 2.5 and Figure 2.6.

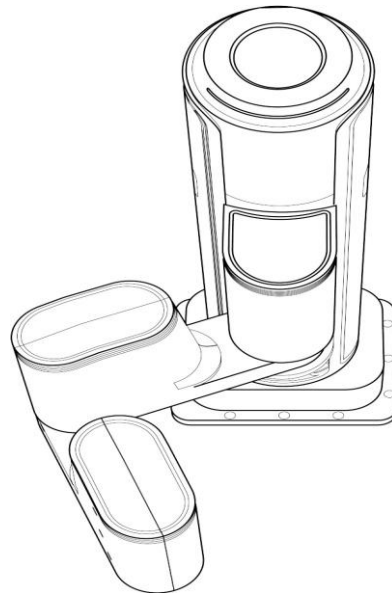

Figure 2.5 Righty hand orientation

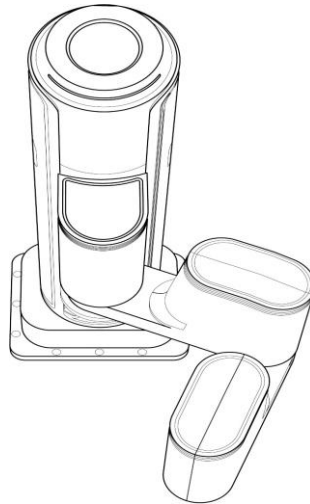

Figure 2.6 Lefty hand orientation

2.3.4 Motion Function

The motion modes of Dobot M1 include Jogging, Point to Point (PTP), ARC, and CIRCLE.

2.3.4.1 Jogging Mode

Jogging mode is the mode jogging Dobot M1 along the Cartesian coordinate system or Joint coordinate system when teaching.

NOTE

This topic describes jogging mode by the GUI operation of M1Studio.

- Cartesian coordinate system mode
 - Click **X+**, **X-** and Dobot M1 will move along X-axis in the negative or positive direction.
 - Click **Y+**, **Y-** and Dobot M1 will move along Y-axis in the negative or positive direction.
 - Click **Z+**, **Z-** and Dobot M1 will move along Z-axis in the negative or positive direction.
 - Click **R+**, **R-** and Dobot M1 will rotate along R-axis in the negative or positive direction.
- Joint coordinate system mode
 - Click **Joint1+**, **Joint1-** and control Rear Arm to rotate in the negative or positive direction.
 - Click **Joint2+**, **Joint2-** and control Forearm to rotate in the negative or positive direction.
 - Click **Joint3+**, **Joint3-** and control Z-axis to move in the negative or positive direction.
 - Click **Joint4+**, **Joint4-** and control R-axis to rotate in the negative or positive direction.

direction.

2.3.4.2 Point to Point Mode (PTP)

PTP mode supports MOVJ, MOVL, and JUMP, which means point to point movement. The trajectory of playback depends on the motion mode.

- **MOVJ**: Joint movement. From point A to point B, each joint will run from initial angle to its target angle, regardless of the trajectory, as shown in Figure 2.7.

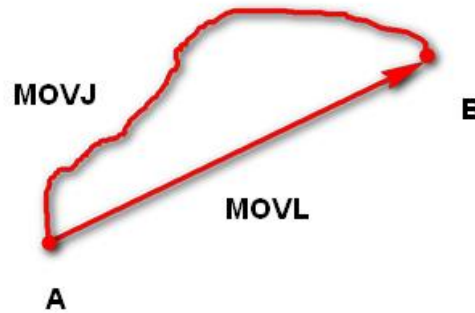

Figure 2.7 MOVL/MOVJ mode

- **MOVL**: Rectilinear movement. The joints will perform a straight line trajectory from point A to point B, as shown in Figure 2.7.
- **JUMP**: From point A to point B, The joints will move in MOVJ mode, of which the trajectory looks like a door, as shown in Figure 2.8.
 1. Move up to the lifting Height (**Height**) in MOVJ mode.
 2. Move up to the maximum lifting height (**Limit**).
 3. Move horizontally to a point that is above B by height.
 4. Move down to a point that is above B by height, which the height of the point is that of point B plus **Height**.
 5. Move down to Point B.

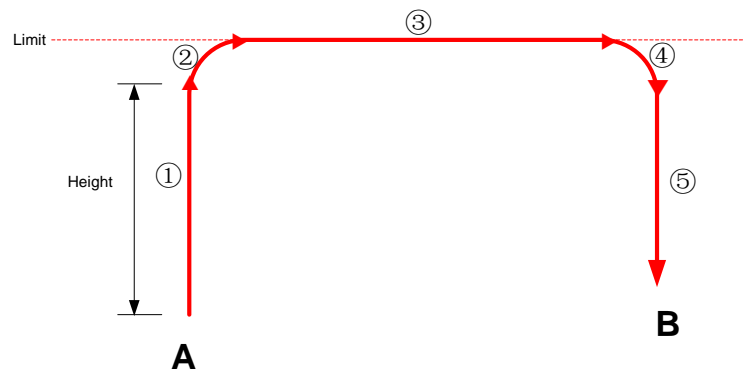
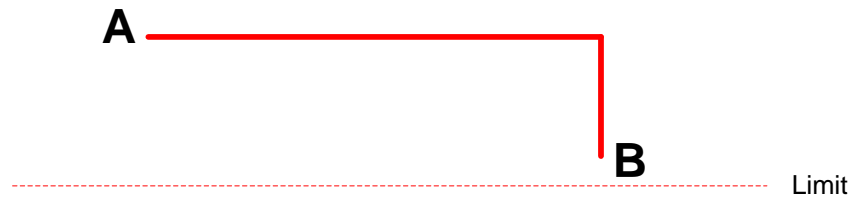

Figure 2.8 JUMP mode

In JUMP mode, if the starting point or the end point is higher than or equal to **Limit**, or the height that the end effector lifts upwards is higher than or equal to **Limit**, the trajectory is different to that of Figure 2.8. Assuming that point A is the starting point, point B is the end point, **Limit** is the maximum lifting height, and **Height** is the lifting height.

- Point A and point B are both higher than **Limit**, but point A is higher than point B.



- Point A and point B are both higher than **Limit**, but point B is higher than point A.



- Point A is higher than **Limit**, but point B is lower than **Limit**.

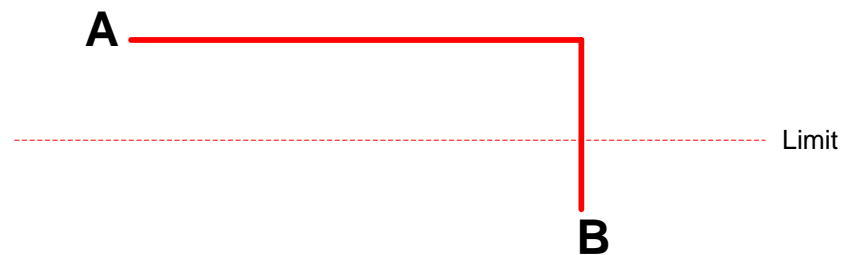

- The height of point A is the same as that of point B, but both are higher than **Limit**.

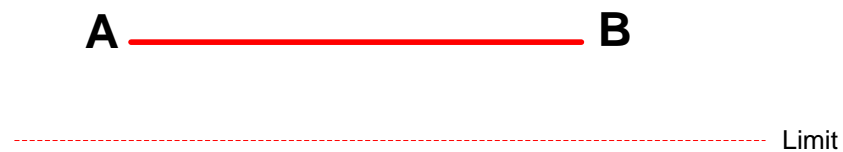

- Point A is lower than **Limit**, but point B is higher than **Limit**.

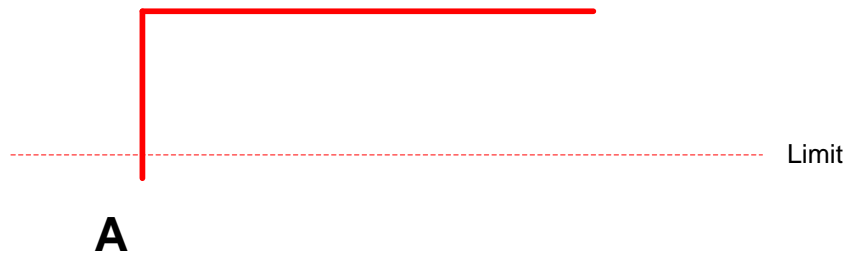

- The height of point A and point B are both the same as **Limit**.



- Point A and point B are both lower than **Limit**, but the height that the height of point A plus **Height** and that of point B plus **Height** is higher than **Limit**.



2.3.4.3 ARC Mode (ARC)

The trajectory of ARC mode is an arc, which is determined by three points (the current point, any point and the end point on the arc), as shown in Figure 2.9.

NOTICE

In ARC mode, it is necessary to confirm the three points with other motion modes, and the three points cannot be in a line.

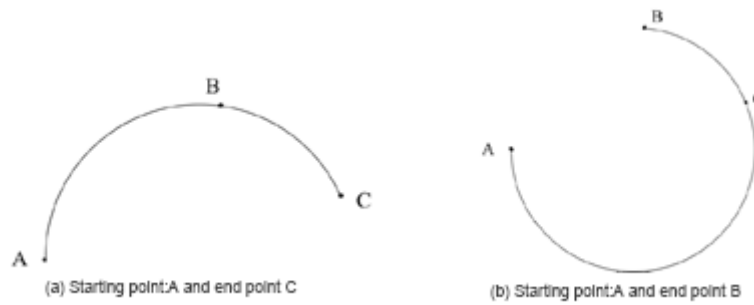

Figure 2.9 ARC mode

2.3.4.4 CIRCLE Mode (CIRCLE)

The CIRCLE mode is similar to ARC mode, of which the trajectory is a circle. In CIRCLE mode, it is necessary to confirm the three points with other motion modes.

2.3.4.5 Application Scenarios

The application scenario depends on the trajectory in motion mode, as shown in Table 2.1.

Table 2.1 Application scenario

Motion mode	Application scenario
MOVL	If the trajectory of playback is required as a straight line, you can choose MOVL
MOVJ	If the trajectory of playback is not required but high speed is required, you can choose MOVJ
JUMP	If the movement of two points is required to lift upwards by amount of height, such as sucking up, grabbing, you can choose JUMP
ARC	If the trajectory of playback is required as an arc, such as dispensing, you can choose ARC
CIRCLE	If the trajectory of playback is required as a circle you can choose CIRCLE

2.4 Technical Specifications

2.4.1 Technical Parameters

Name	Dobot M1		
Reach	400mm		
Rated payload	1.5kg		
Maximum	Type	Mechanical limitation	Software limitation

magnitude	Rear arm	-90 ° 90 °	-85 ° 85 °
	Forearm	-135 ° 135 °	-135 ° 135 °
	Z-axis screw	0mm- 250mm	10mm- 235mm
	End-effector rotation	-360 ° 360 °	-360 ° 60 °
Maximum speed	Joint speed of Forearm and Rear Arm	180 %s	
	Resultant speed of the Forearm and Rear Arm	2000mm/s	
	Speed of Z-axis	1000mm/s	
Repeatability	0.02mm		
Power	Power Adapter: 100V-240V AC,50/60Hz Dobot M1: 48V DC		
System	Linux		
Communication interface	Ethernet, RS-232C		
I/O	<ul style="list-style-type: none"> • 22 digital outputs • 24 digital inputs • 6 ADC inputs 		
Software	M1Studio		

NOTE

Mechanical Limitation: Limit the position of Dobot M1 by mechanical parts.

Software Limitation: For protection, limit the position of Dobot M1 by software.

2.4.2 Sizes

Figure 2.10 shows the size of Dobot M1.

NOTE

Z-axis Motion Range shown in Figure 2.10 indicates the mechanical limitation.

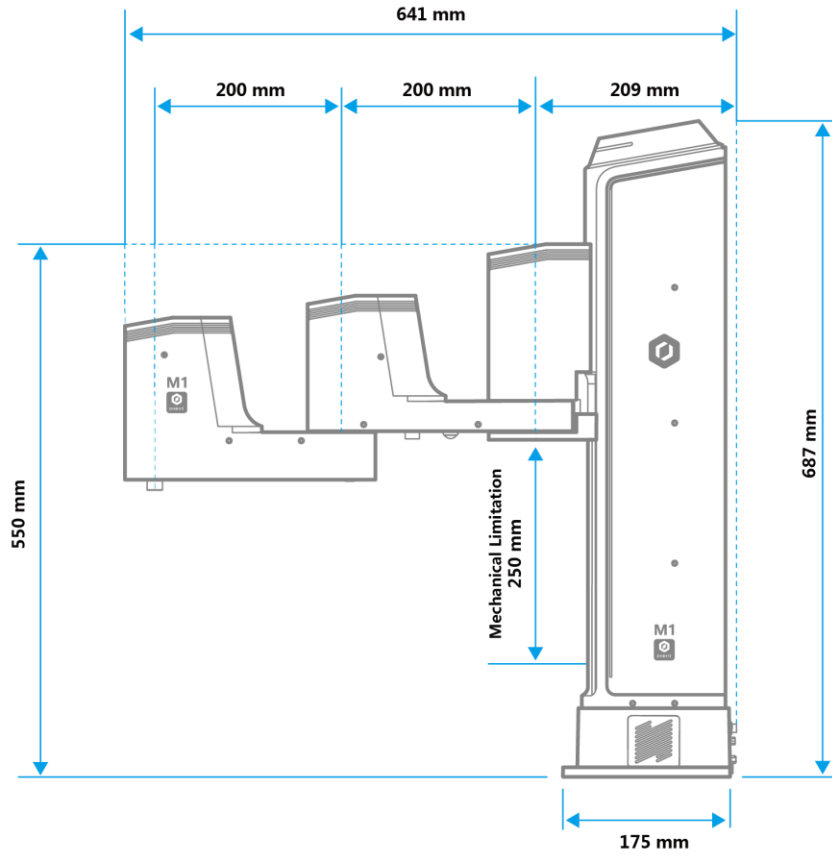

Figure 2.10 Size of Dobot M1

3. Hardware Installation

3.1 Environment Requirements

The operating temperature of Dobot M1 ranges from 5 °C to 40 °C. The operating humidity ranges from 45% to 75% (non-condensing).

3.2 Installing the Base of Dobot M1

The stability of Dobot M1 depends on the installation of the base of Dobot M1. You can design the platform according to the size of the hole of the base and the real environment for fixing Dobot M1. The platform must not only bear Dobot M1, but also bear the dynamic force by the maximum acceleration. Note the following before installing the platform.

- Design the platform according to the workspace of Dobot M1, and ensure that Dobot M1 moves without interference.
- Keep the platform level which is used to support Dobot M1.
- Do not put water or other drinks near or on the platform, in order to avoid potential safety hazard because of liquid leakage.

Procedure

Step 1 Check the packaging of Dobot M1, and confirm that the contents of the box are consistent with the packaging list.

Step 2 Open the holes on the work platform according to the size of the hole of the base.

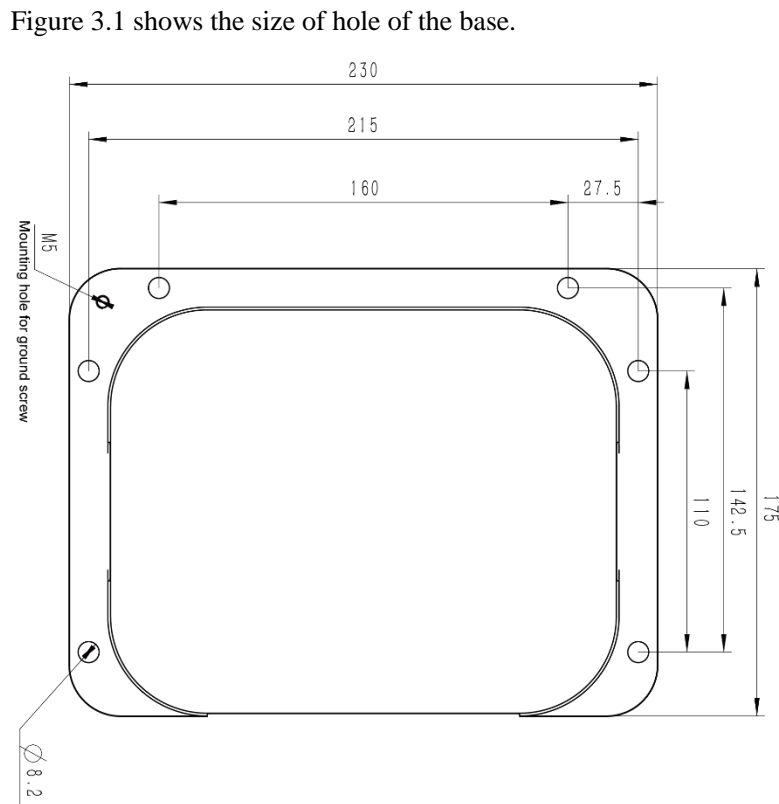

Figure 3.1 Size of the base

Step 3 Move Dobot M1 to the platform, align the base of Dobot M1 with the holes, and then use the hexagon wrench and six M6 bolts to fix Dobot M1.

3.3 (Optional) Installing End Effector

You can install the matching gripper, suction cup, or laser on the end effector of Dobot M1 for transporting, intelligent sorting and laser engraving. Figure 3.2 shows the size of the end effector of Dobot M1.

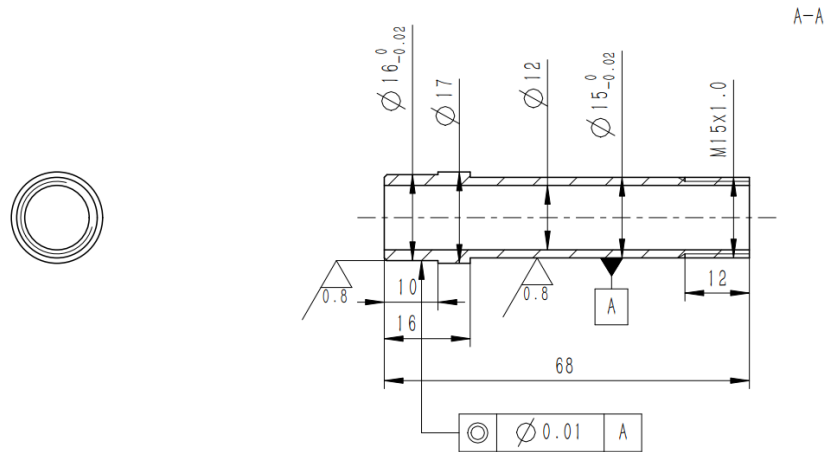

Figure 3.2 Size of the terminal

3.3.1 Installing Laser Engraving Kit

Figure 3.3 shows the laser kit.



Figure 3.3 Laser kit

Procedure

Step 1 Install the laser kit on the end effector and tighten the screws of the laser kit using

2.5# hexagon wrench.

- Step 2** Connect the connector of the laser kit to the Forearm I/O interface, as shown in Figure 3.4.



Figure 3.4 connect to Forearm I/O interface

3.3.2 Installing 3D Printing Kit

Figure 3.5 shows the 3D printing kit.

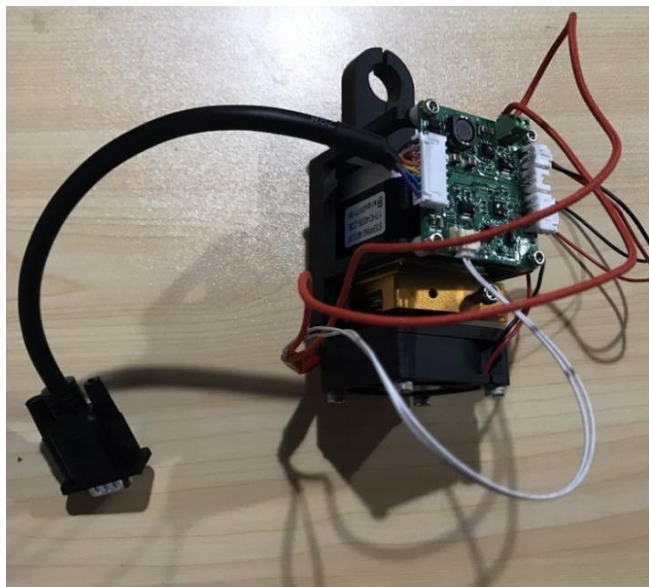

Figure 3.5 3D printing kit

Procedure

- Step 1** Install the 3D printing kit on the end effector to make the printing head and Forearm in a straight line and tighten the screws of the 3D printing kit using 2.5# hexagon wrench.
- Step 2** Connect the connector of the 3D printing kit to the Forearm I/O interface, as shown in Figure 3.6.

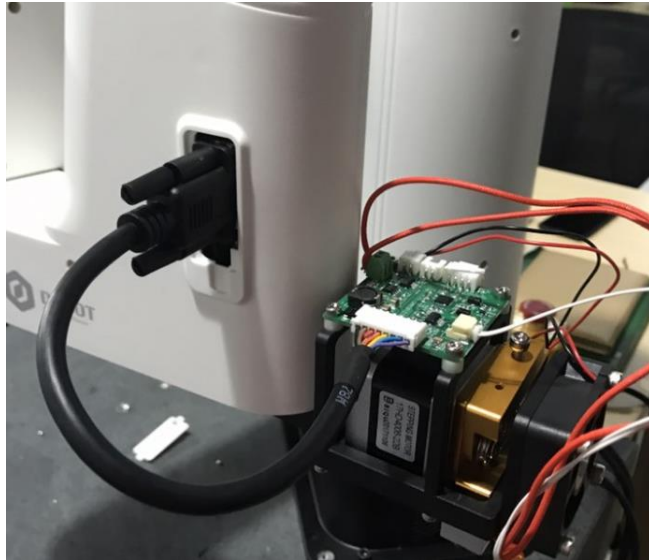

Figure 3.6 Connect to Forearm I/O interface

- Step 3** Install 3D printing filament. Please prepare the filament. Press down the lever on the extruder by hand, and push down the filament to the bottom via pulley, as shown in Figure 3.7 and Figure 3.8.

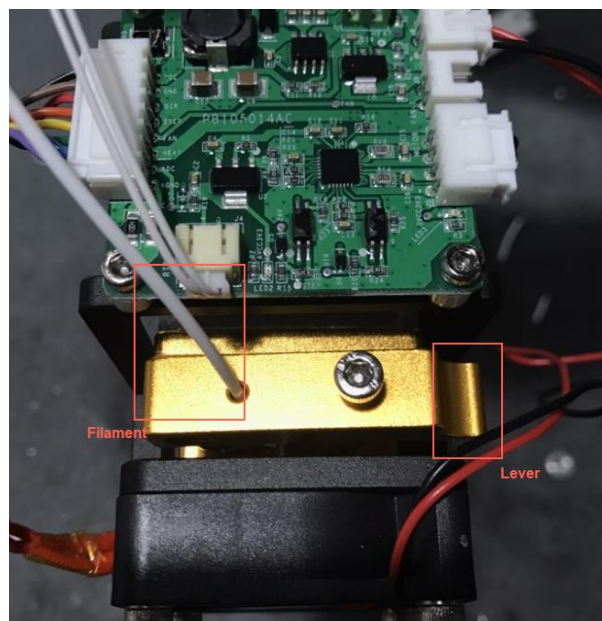

Figure 3.7 Push down the filament (1)

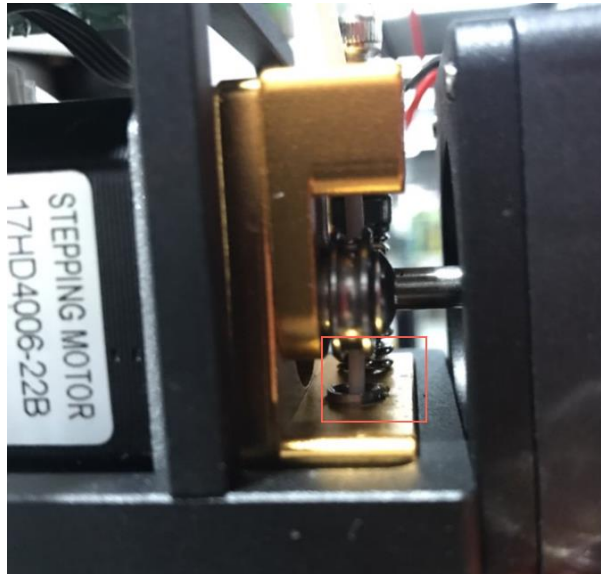

Figure 3.8 Push down the filament (2)

3.4 (Optional) Installing Air Pump

It is necessary to install the matching air pump when using the gripper or suction cup for grabbing objects. The air pump is controlled over the I/O interface. For details, please see 6.7 *Operating I/O Assistant*. The Air pump that we provided is used for debugging I/O interface. In real applications, please select a professional one.

Figure 3.9 shows the air pump. Table 3.1 lists the description of the cables that are shown in the yellow box of this figure.

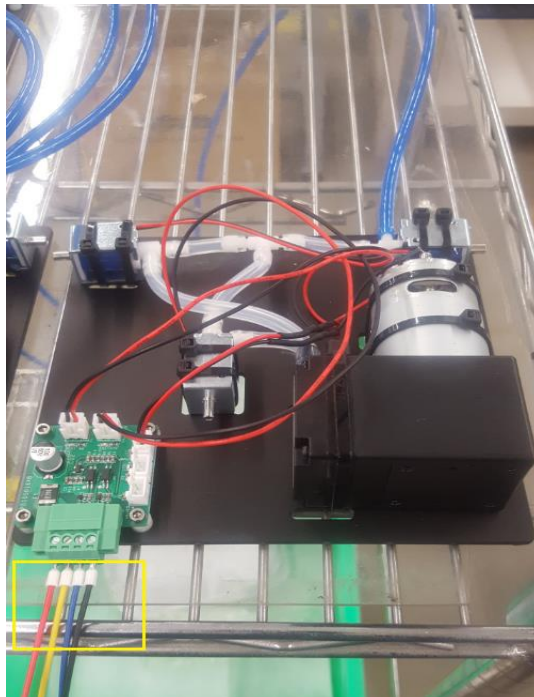

Figure 3.9 Air pump

The appearance of the air pump depends on the production batch of Dobot M1. However, the connection method remains unchanged.

Table 3.1 Cable Description

Color	Description
Red	VCC_24V
Black	PGND
Yellow	OUT1: Control the intake and outtake of the air pump
Blue	OUT2: Control the status of the air pump

If the air pump is connected to the base I/O interface. The yellow cable and the blue one are connected to the output pins (The corresponding outputs listed in 4.3.2.2 *Base I/O Interface* are DOUT17 and DOUT18) of the base I/O interface. The red one and the black one are connected to the VCC_24V pin on the base I/O interface and the PGND pin on the CAN bus interface respectively, as shown in Figure 3.10, and you need to tighten them with a straight screwdriver. The description in this topic is for reference only. Please choose the appropriate interface to connect the air pump. For details, please see 4.3 *Interface Description*.

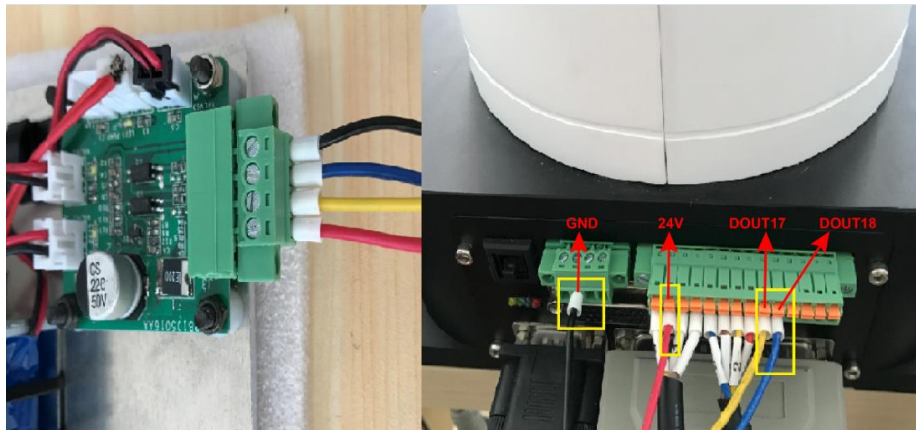

Figure 3.10 Air pump connection

When air pump is connected to I/O interface, the terminals of air pump cannot be exposed to the air, to avoid short circuit. For matching all I/O interfaces, terminals of air pump will be slightly longer. If that happens, you need to cut them to an appropriate length. Figure 3.11 and Figure 3.12 show the standard and non-standard connection of the terminals respectively.

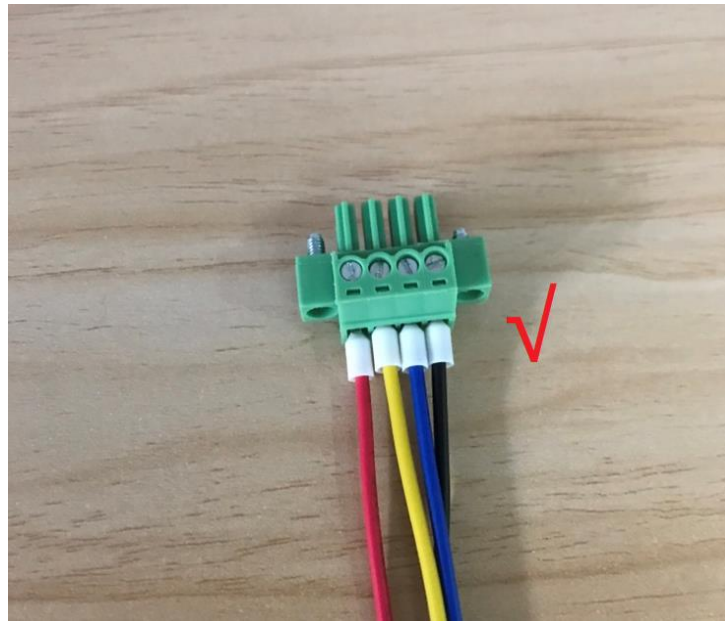

Figure 3.11 Standard connection

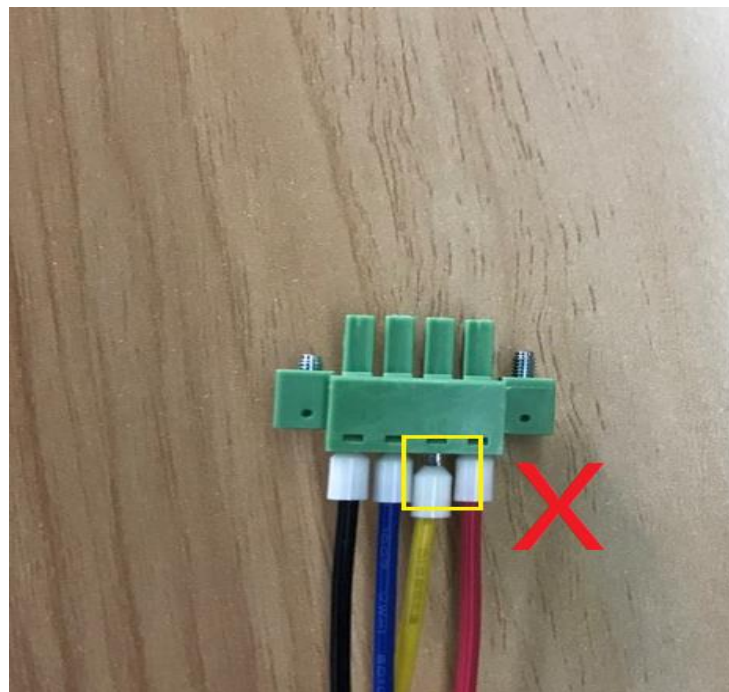

Figure 3.12 Non-standard connection

4. Electrical Specifications

The address of the I/O interfaces of Dobot M1 are unified.

4.1 Interface Board

The interface board of Dobot M1 is located on the back of the base. If the SN number of Dobot M1 is **DT211812xxx** and later numbers, the interface board is shown in Figure 4.1.

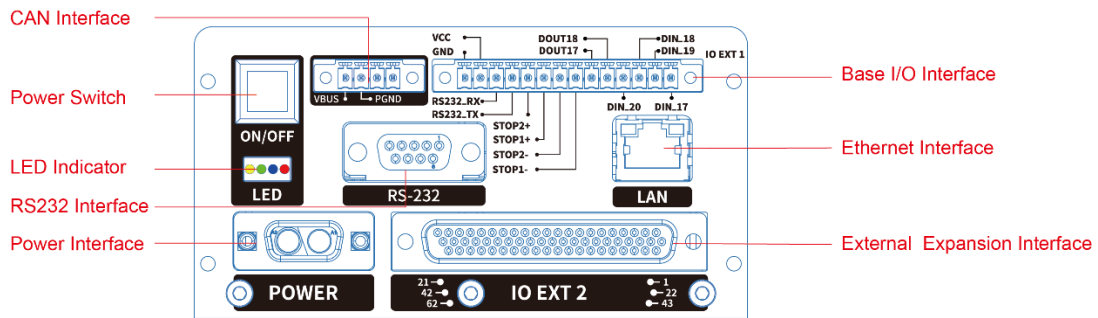

Figure 4.1 Base interface description

If the SN number of Dobot M1 is **DT211811xxx** and earlier numbers, as shown in Figure 4.2. Table 4.1 shows the function description.

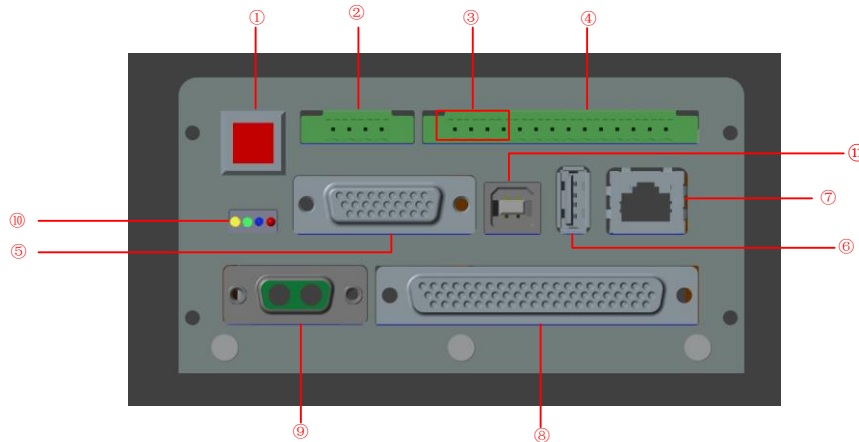

Figure 4.2 Interface board of Dobot M1

Table 4.1 Description of the interface board

No.	Description
1	Power switch of Dobot M1
2	CAN interface
3	RS-232C interface
4	Base I/O interface

5	Teaching device interface, reserved
6	USB HOST interface, reserved
7	Ethernet interface
8	External expansion interface
9	Power interface
10	LED indicators
11	Reserved interface

4.2 LED Indicators

Table 4.2 lists the status of the LED indicators on the interface board and the external power box

Table 4.2 Description of the LED indicators

Item	Description
External power box indicator	The LED indicator is steady on when the external power box is powered on.
System indicator	<ul style="list-style-type: none"> All the LED indicators are off when Dobot M1 is powered off Yellow LED indicator: when powering on, the yellow LED indicator in the base is steady on for about 15 seconds, and then blinks once. It is steady on again for about 5 seconds Green LED indicator: when powered on, the yellow LED indicator in the base is off, the green one is steady on for about 5 seconds, and then is blinking. That means, Dobot M1 is in service Blue LED indicator: The blue one is blinking, indicating that Dobot M1 is working in offline mode Red LED indicator: The red one is steady on, indicating that an alarm is generated when Dobot M1 is running

4.3 Interface Description



NOTICE

In this topic, PGND indicates the reference ground corresponding to 24V or 48V, AGND indicates the reference ground corresponding to analog signal, and GND indicates the reference ground corresponding to all signals.

4.3.1 Power Adapter Interface

4.3.1.1 AC Input Interface



Figure 4.3 shows the power adapter. For details on how to connect Dobot M1 to power adapter, please see *5.2.1 Connecting Power Supply*.



Figure 4.3 Power adapter

Table 4.3 The power adapter input interface description

No.	Name	Function	Voltage/Current
1	AC_L	L of the AC power	100V-240V AC/2.6A
2	AC_N	N of the AC power	100V-240V AC/2.6A
3	GND	GND	GND

4.3.1.2 DC output Interface

Table 4.4 The power adapter output interface description

No.	Name	Function	Voltage/Current
1	V+	Positive electrode of the DC power	48V DC/5A
2	V-	Negative electrode of the DC power	GND/5A

4.3.2 Body I/O Interface



The current of the digital output supports 2mA without additional power, whereas the maximum current of the digital output supports 3A with additional power.

4.3.2.1 Power Interface

Table 4.5 Description of the power interface

PIN	Name	Function	Voltage/Current
1	VIN	Positive electrode of the DC power	48V DC/5A
2	PGND	Negative electrode of the DC power	GND/5A

4.3.2.2 Base I/O Interface

Table 4.6 Description of the base I/O interface

PIN	Name	Function	Voltage/Current
1	GND	Negative electrode of the logic power	GND/2A
2	VCC	Positive electrode of the logic power	24V DC/2A
3	RS232_RX	RS232 acception	RS232 level
4	RS232_TX	RS232 transmission	RS232 level
5	STOP2+	Positive electrode of the safety input 2, used for connecting to emergency stop switch	0V,24V/<100mA
6	STOP1+	Positive electrode of the safety input 1, used for connecting to emergency stop switch	0V,24V/<100mA
7	STOP2-	Negative electrode of safety input 2, used for connecting to emergency stop switch	0V,24V/<100mA
8	STOP1-	Negative electrode of safety input 1, used for connecting to emergency stop switch	0V,24V/<100mA
9	DOUT17	Digital output	0V,24V/2mA
10	DOUT18	Digital output	0V,24/2mA
11	DIN_20	Digital input	0V,24V/<100mA
12	DIN_18	Digital input	0V,24V/<100mA
13	DIN_19	Digital input	0V,24V/<100mA
14	DIN_17	Digital input	0V,24V/<100mA

4.3.2.3 CAN Bus Interface

Table 4.7 The CAN bus interface description

PIN	Name	Function	Voltage/Current
1	VBUS	Positive of VBUS, reserved	48V/5A
2	PGND	Negative of VBUS	GND/5A
3	CAN1_H	CAN bus, reserved	CAN level
4	CAN1_L	CAN bus, reserved	CAN level

4.3.2.4 Forearm I/O Interface

Table 4.8 The Forearm I/O interface description

PIN	Name	Function	Voltage/Current
1	VCC	Positive electrode of the logic power	24V/2A
2	DOUT19	Digital output	0V,24V/2mA
3	DOUT20	Digital output	0V,24V/2mA
4	DOUT21	Digital output	0V,24V/2mA
5	DOUT22	Digital output	0V,24V/2mA
6	AIN5	Analog input	0V-12V/<100mA
7	AIN6	Analog input	0V-12V/<100mA
8	AGND	Negative electrode of the logic power	AGND/1A
9	RS485_A	RS485A bus	RS485 RS485 level
10	RS485_B	RS485B bus	RS485 RS485 level
11	DIN21	Digital input	0V,24V/<100mA
12	DIN22	Digital input	0V,24V/<100mA
13	DIN23	Digital input	0V,24V/<100mA
14	DIN24	Digital input	0V,24V/<100mA
15	GND	Negative electrode of the logic power	GND/2A

4.3.3 External Expansion Interface

Table 4.9 The external expansion interface description

PIN	Name	Function	Voltage/Current
1	A1-	Inversion signal input for A phase of external encoder1	RS422 level
2	A1+	Signal input for A phase of external encoder1	RS422 level
3	DIN1	Digital input	0V,24V/<100mA
4	DIN4	Digital input	0V,24V/<100mA
5	DIN3	Digital input	24V/<100mA
6	AOUT2	Analog output, reserved	0V~10V/10mA
7	CAN2_H	CAN bus	CAN CAN bus
8	DIN6	Digital input	0V,24V/<100mA
9	DIN5	Digital input	0V,24V/<100mA
10	AIN2	Analog input	0V-10V/<100mA
11	AIN3	Analog input	0V-10V/<100mA
12	DIN7	Digital input	0V,24V/<100mA
13	DIN10	Reset signal	0V,24V/<100mA
14	DIN9	Digital input	0V,24V/<100mA
15	DIN12	Continue signal	0V,24V/<100mA
16	FPGA_DOUT6 (DOUT16)	Digital output	0V,24V/2mA
17	FPGA_DOUT5 (DOUT15)	Digital output	0V,24V/2mA
18	DIN11	External I/O control signal. Namely, Dobot M1 activates external I/O control function	0V,24V/<100mA

PIN	Name	Function	Voltage/Current
19	DIN14	Stop signal After this signal is triggered, Dobot M1 will stop offline running while the external I/O control will remain in force. At this point, you can use M1Studio to control Dobot M1 in Dobot mode or trigger DIN 15 to make Dobot M1 run in offline mode again	0V,24V/<100mA
20	DIN13	Pause signal	0V,24V/<100mA
21	DIN15	Start signal, for running in offline mode Before triggering this signal, please trigger DIN 11 first	0V,24V/<100mA
22	B1+	Signal input for B phase of external encoder1	RS422 level
23	B1-	Inversion signal input for B phase of external encoder1	RS422 level
24	DOUT2	Digital output	0V,24V/2mA
25	DOUT1	Digital output	0V,24V/2mA
26	DIN2	Digital input	0V,24V/<100mA
27	DOUT4	Digital output	0V,24V/2mA
28	DOUT3	Digital output	0V,24V/2mA
29	CAN2_L	CAN bus	CAN level
30	DOUT5	Digital output	0V,24V/2mA
31	DOUT7	Digital output	0V,24V/2mA
32	DIN8	Digital input	0V,24V/<100mA
33	AIN4	Analog input	0V~10V/<100mA
34	FPGA_DOUT2 (DOUT12)	Digital output	0V,24V/2mA
35	FPGA_DOUT4 (DOUT14)	Digital output	0V,24V/2mA

PIN	Name	Function	Voltage/Current
36	FPGA_DOUT3 (DOUT13)	Digital output	0V,24V/2mA
37	DIN16	Digital input	0V,24V/<100mA
38	PGND	Negative of the logic power	GND/5A
39	PGND	Negative of the logic power	GND/5A
40	VCC	Positive of the logic power	24V/3A
41	VCC	Positive of the logic power	24V/3A
42	VCC	Positive of the logic power	24V/3A
43	B2-	Inversion signal input for B phase of external encoder2	RS422 level
44	B2+	Signal input for B phase of external encoder2	RS422 level
45	A2+	Signal input for A phase of external encoder2	RS422 level
46	A2-	Inversion signal input for A phase of external encoder2	RS422 level
47	RS_485_A	RS485A bus	RRS485 level
48	RS_485_B	RS485B bus	RS485 level
49	AOUT1	Analog output, reserved	0V-10V/10mA
50	DOUT6	Digital output	0V,24V/2mA
51	DOUT8	Digital output	0V,24V/2mA
52	AIN1	Analog input	0V-10V/<100mA
53	DOUT10	Digital output	0V,24V/2mA
54	DOUT9	Digital output	0V,24V/2mA
55	FPGA_DOUT1 (DOUT11)	Digital output	0V,24V/2mA
56	GND	Negative of the analog power	GND/1A
57	PGND	Negative of the logic power	GND/5A
58	PGND	Negative of the logic power	GND/5A
59	PGND	Negative of the logic power	GND/5A
60	ON_OFF-	Negative of the power signal	0V-24V/<100mA

PIN	Name	Function	Voltage/Current
61	ON_OFF+	Positive of the power signal	0V-24V/<100mA
62	VCC	Positive of the logic power	5V/2A

4.3.4 Communication Interface

4.3.4.1 Ethernet Interface

Dobot M1 can connect to a PC over standard RJ45 Socket interface, using TCP/IP.

4.3.4.2 RS-232 Interface

Dobot M1 can connect to a PC over standard RS-232 interface.

5. Installation and Commissioning

5.1 Installing Software

The main software for Dobot M1 is M1Studio. You can use playback, script control, 3D printing, etc.

5.1.1 Environment Requirements

The supported OSs are as follows.

- Win7
- Win8
- Win10

5.1.2 Obtaining M1Studio Software Package

Before operating Dobot M1, please download the correct version of M1Studio. The path is www.dobot.cc/downloadcenter/dobot-m1.html#most-download.

5.1.3 Installing M1Studio

Prerequisites

You have obtained the M1Studio software.

Procedure

- Step 1** Decompress the M1Studio software.
If the directory containing decompressed M1Studio files is **E:\M1Studio**. Please replace the directory based on site requirements.
- Step 2** Double-click **M1Studio.exe** in the **E:\M1Studio** directory.
The **Select Setup Language** page is displayed
- Step 3** Choose the installation language based on site requirements.
- Step 4** Click **Next**.
- Step 5** Click **Browse...** to choose the installation path of M1Studio on the **Setup-M1Studio** page, and click **Next**.

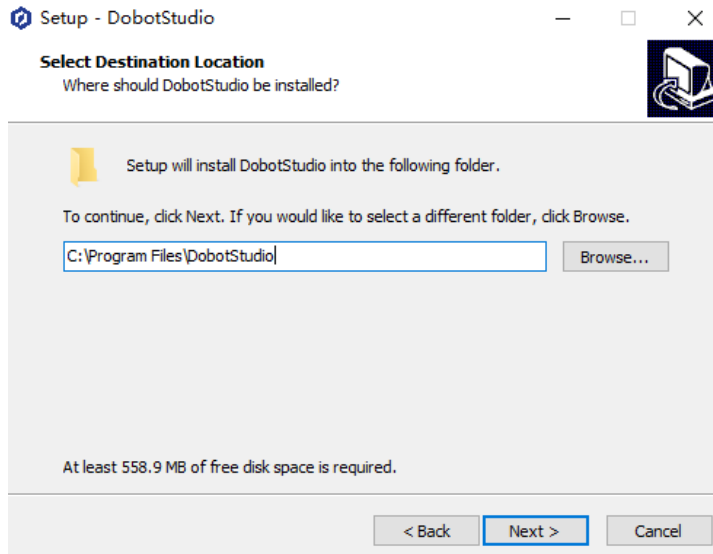

Figure 5.1 The M1Studio installation GUI

Step 6 Select **Create a desktop shortcut** and click **Next**.

Step 7 Click **Install**.

After 40 seconds later, the **FTDI CDM Drivers** page is displayed, as shown in Figure 5.2.

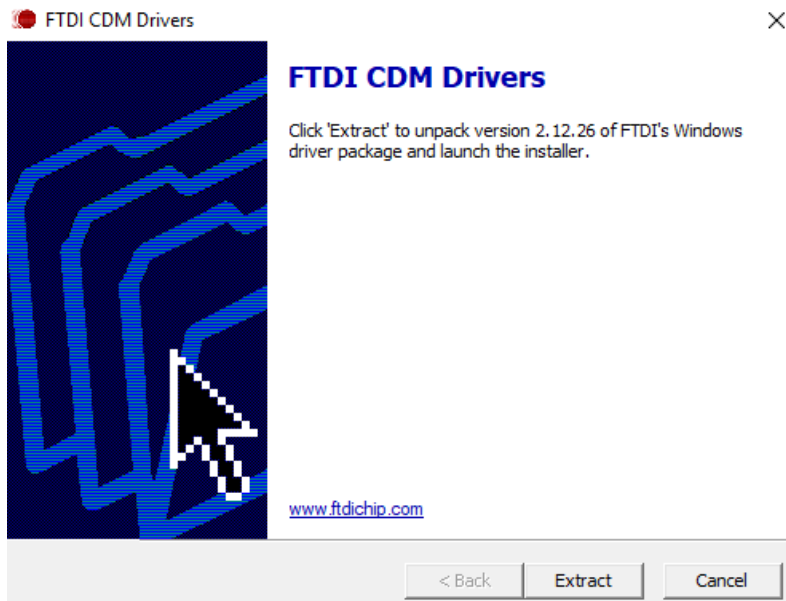

Figure 5.2 FTDI CDM Drivers GUI

Step 8 Install the USB driver as the tips on the **FTDI CDM Drivers** page.

Step 9 Click **Next** on the **Setup-M1Studio** page after the USB driver has been installed.

Step 10 Click **Finish**.

5.1.4 Verifying Installation

Please double-click M1Studio after installation. If M1Studio can be started, the installation is successful.

5.1.5 Troubleshooting

If M1Studio is not running, you need to install all VC++ libraries in the **C:\Program Files\M1Studio\attachment** directory, as shown in Figure 5.3.

C:\Program Files\M1Studio indicates the installation directory of M1Studio, please replace the installation directory based on site requirements.

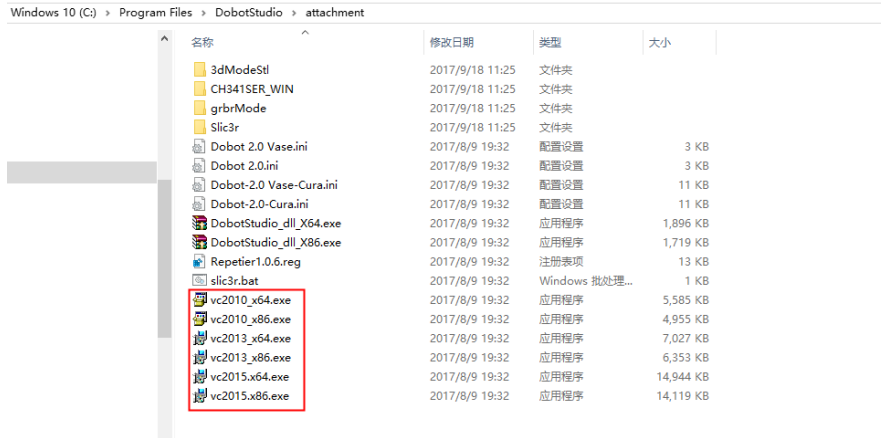

Figure 5.3 The VC++ libraries

5.2 Connecting Cables

5.2.1 Connecting Power Supply

Figure 5.4 shows the power supply cables and power adapter. No.1 in Figure 5.4 indicates power supply output cable, No.2 indicates power supply input cable, and No.3 indicates power adapter.



Figure 5.4 Power cables and power adapter

The input and output interfaces of the power adapter are shown in Table 5.1 and Table 5.2.

Table 5.1 The power adapter input interface description

No.	Name	Function	Voltage/Current
1	AC_L	L of the AC power	100V-240V AC/2.6A
2	AC_N	N of the AC power	100V-240V AC/2.6A
3	GND	GND	GND

Table 5.2 The power adapter output interface description

No.	Name	Function	Voltage/Current
1	V+	Positive electrode of the DC power	48V DC/5A
2	V-	Negative electrode of the DC power	GND/5A

Procedure

- Step 1** Connect the yellow-green cable on one end of the power supply input cable to the GND pin on the power adapter, the blue one to the N pin and the brown one to the L pin. Tighten them with a cross screwdriver, as shown in Figure 5.5. If you cannot connect, please loosen the cage clamp firstly with the cross screwdriver.



Figure 5.5 Connect power supply input cable to power adapter

⚠ NOTICE

If the type of the power input supply is America-standard, please connect the G pin on the power input supply to the Ground pin on the power adapter, the W pin to the N pin, and the Z pin to the L pin.

- Step 2** Connect the red cable on one end of the power supply output cable to the V+ pin on the power adapter, the black one to the V- pin. Tighten them with a cross screwdriver, as shown in Figure 5.6. If you cannot connect, please loosen the cage clamp firstly with the cross screwdriver.



Figure 5.6 Connect power supply output cable to power adapter

- Step 3** Connect the other end of the power supply output cable to the power interface on the base of Dobot M1, as shown in Figure 5.7.

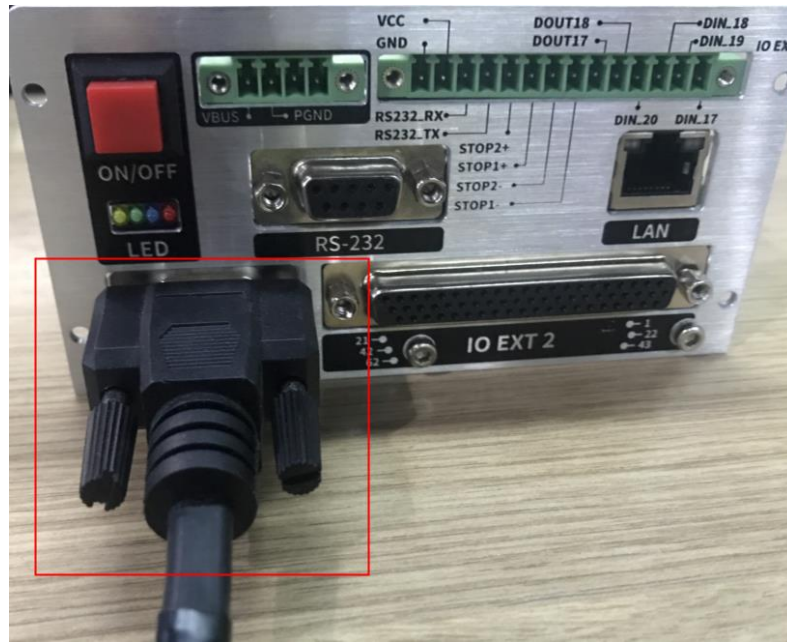

Figure 5.7 Connect to Dobot M1

Step 4 Connect the other end of the power supply input cable to the 220V AC socket.

5.2.2 Connecting Emergency Stop Switch

Before operating Dobot M1, please connect it to the emergency stop switch to ensure that Dobot M1 can be stopped immediately during running.

When powering on for the first time, please ensure that the emergency stop switch has been opened (The emergency stop button is bumped). Otherwise, the robotic arm will not work normally. If the emergency stop switch is not opened, please rotate the emergency stop button clockwise. The emergency stop button will be bumped when rotating to 45°.

Procedure

Please connect the terminal block connector with the emergency stop switch to the base I/O interface, and you need to tighten the terminal block connector with a straight screwdriver as shown in Figure 5.8 and Figure 5.9.

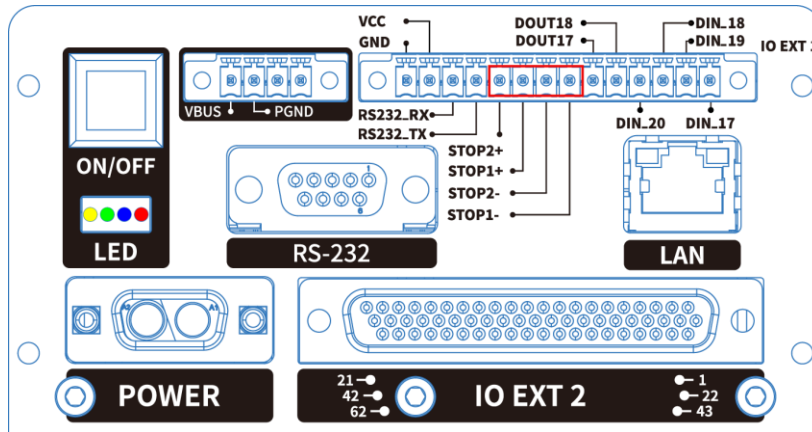

Figure 5.8 Connection between Dobot M1 and the emergency stop switch (1)



Figure 5.9 Connection between Dobot M1 and the emergency stop switch (2)

5.2.3 Connecting Serial Port

Prerequisites

The USB to serial line has been obtained. One end is standard USB port, the other end is 9-pins serial port.

If the SN number of Dobot M1 is **DT211811xxx** and earlier numbers, please prepare USB to serial line by yourself.

Procedure

- Step 1** Connect the serial port of the USB to serial line to the RS232 interface on the base. If the SN number of Dobot M1 is **DT211812xxx** and later numbers, please connect the serial port of the USB to serial line to the RS232 interface directly, as shown in

Figure 5.10.

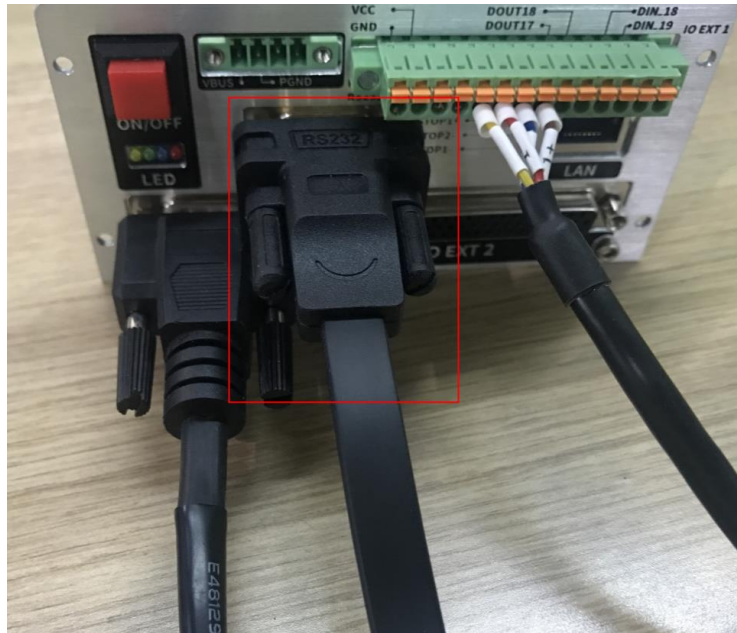

Figure 5.10 Serial port connection (1)

If the SN number of Dobot M1 is **DT211811xxx** and earlier numbers, please connect the serial port of the USB to serial line to the extension line of the RS232 interface, as shown in Figure 5.11.

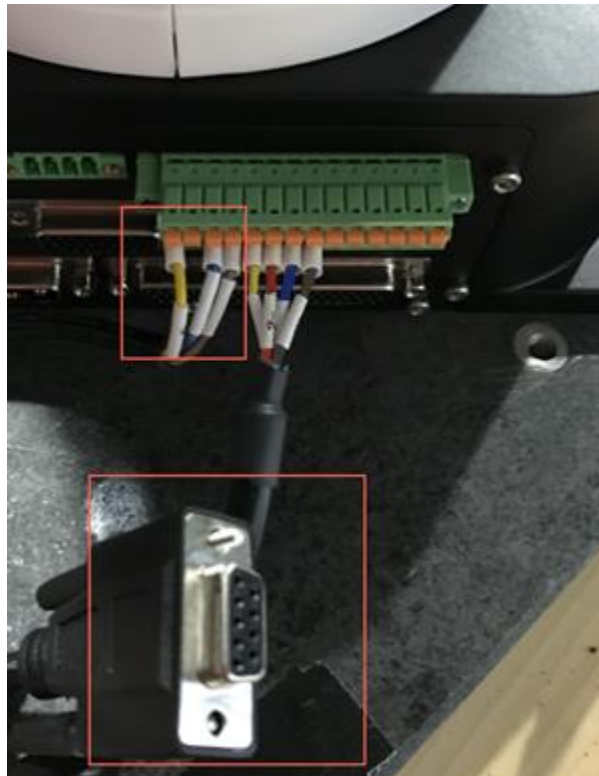

Figure 5.11 Serial port connection (2)

Step 2 Connect the USB port of the USB to serial line to the USB port of the PC.

Step 3 Power on Dobot M1 and launch M1Studio

After startup, you can check the corresponding serial information from the serial drop-down list on the upper left pane of the M1Studio page and click Connect, as shown in Figure 5.12.

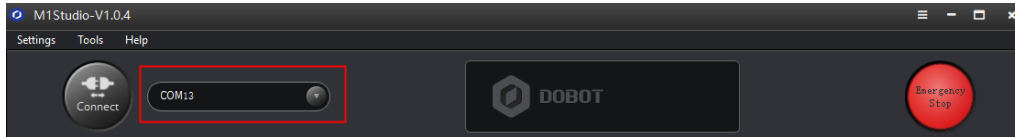

Figure 5.12 Serial information of M1Studio

5.2.4 (Optional) Connecting Network Cable

In addition to the USB to serial line, you can also use a network cable to connect Dobot M1 and PC, and the IP address of Dobot M1 and PC must be in the same network segment.

5.2.4.1 Connecting directly

This topic describes how to connect Dobot M1 and PC with network cable directly and a PC can only control single Dobot M1. The connection is shown as Figure 5.13.

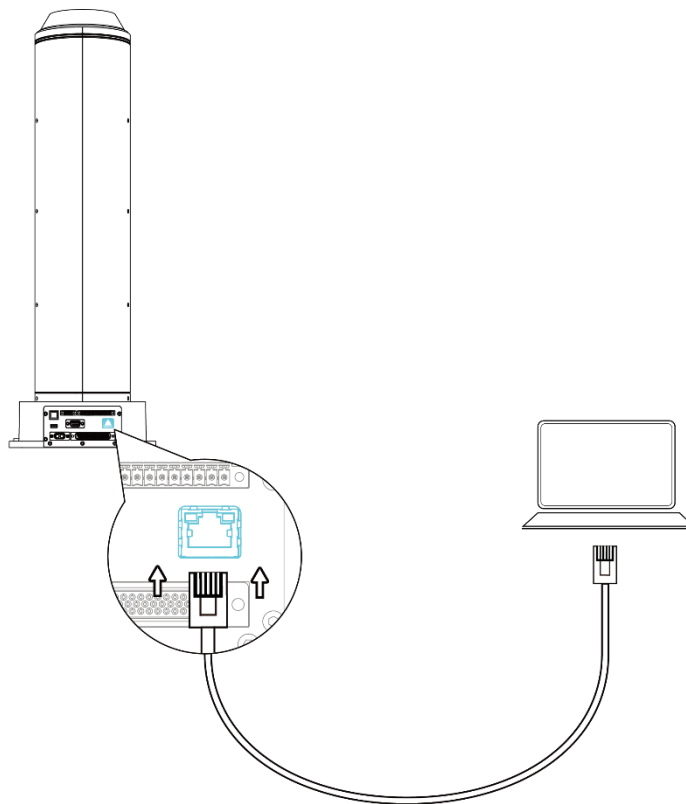

Figure 5.13 Direct connection

- If the SN number of Dobot M1 is **DT211812xxx** and later numbers, please connect them as the flowing steps.

xxx is random number, please replace it based on site requirements.

Step 1 Power on Dobot M1 and launch M1Studio.

Step 2 Select **Tools > Force Configure IP...** on the M1Studio page.

The forced configuration page is displayed.

Step 3 Click **Force Configure IP**, the IP address of Dobot M1 will be forced set in the same segment network of the PC, as shown in Figure 5.14.

⚠ NOTICE

Please make sure that the IP address of PC belongs to class C networks when configuring IP address. Otherwise, the forced configuration will be failed.

Class C IP addresses range: 192.0.0.0 - 223.255.255.255. Default subnet mask: 255.255.255.0.



Figure 5.14 Forced configuration

After closing the forced configuration page, you can check the corresponding IP address from the serial drop-down list on the upper left pane of the M1Studio page and click **Connect**, as shown in Figure 5.15.

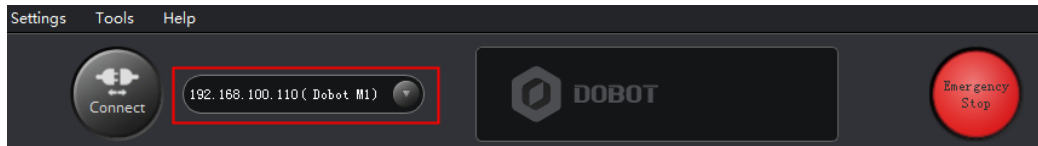

Figure 5.15 IP address information

- If the SN number of Dobot M1 is **DT211811xxx** and earlier numbers, please connect them as the flowing steps.

If the local IP address, subnet mask of the PC are **192.168.1.10**, **255.255.255.0** respectively. You can run the command **ipconfig /all** on the CMD console window to view the IP information of the PC.

⚠ NOTICE

- Please make sure that the PC address of PC belongs to class C networks when configuring IP address. Otherwise, the configuration will be failed.
Class C IP addresses range: 192.0.0.0 - 223.255.255.255. Default subnet mask: 255.255.255.0.
- The IP address of Dobot M1 and the PC must be on the same network segment without conflict. The subnet masks of them must be the same.

Step 1 Select the corresponding serial port from the serial drop-down list on the upper left pane of the M1Studio page and click **Connect**.

If **Connect** turns to **Disconnect**, the connection is successful.

Step 2 Select **IP Address Setting** on the M1Studio page.

The **Dobot M1 IP Address Setting** page is displayed.

Step 3 Modify **IP Address** and **Netmask** on the **Dobot M1 IP Address Setting** page.

Step 4 Click **Confirm**.

If **Network Status of Dobot M1** turns to **Connected to LAN**, the modification is successful.

Step 5 Click **Disconnect** on the upper left pane of the M1Studio page.

About 2 seconds later, select the modified IP address from the drop-down list on the upper left pane of the M1Studio page, and click **Connect**.

5.2.4.2 Connecting Via Router

This topic describes how to connect PC and Dobot M1 with router and a PC can control multiple Dobot M1 simultaneously.

Prerequisites

PC has been connected to a router.

Procedure

Step 1 Connect one end of the network cable to Ethernet interface on the base of Dobot M1.

Step 2 Connect the other end of the network cable to the router which also connects the PC, as shown in Figure 5.16.

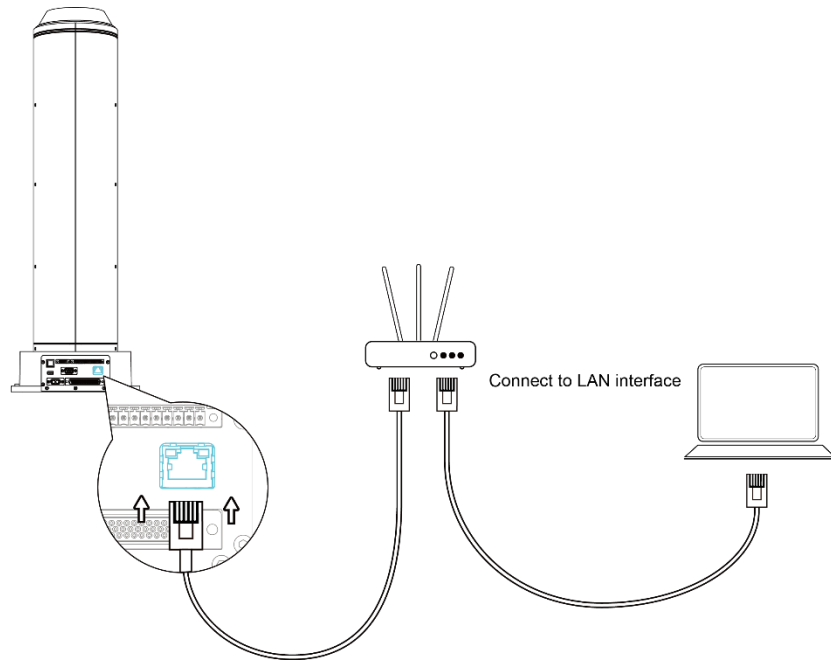

Figure 5.16 Connect via router

Step 3 Power on Dobot M1 and launch M1Studio.

You can check the corresponding IP address from the serial drop-down list on the upper left pane of the M1Studio page and click **Connect**, as shown in Figure 5.17.

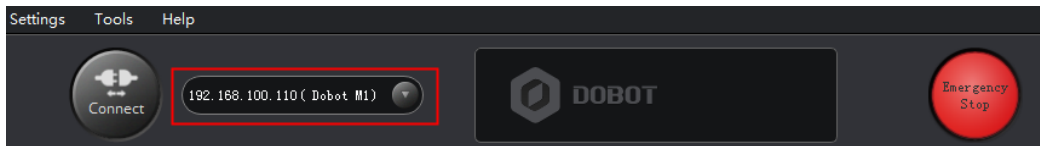

Figure 5.17 IP address information

Abnormal Handling

If the IP address is not displayed on the upper left pane of the M1Studio page after powering on Dobot M1, please obtain the IP address as the following steps.

Step 1 Select the corresponding serial port from the serial drop-down list on the upper left pane of the M1Studio page and click **Connect**.

If **Connect** turns to **Disconnect**, the connection is successful.

Step 2 Select **Tools > IP Address Setting** on the M1Studio page.

The **Dobot M1 IP Address Setting** is displayed.

Step 3 Select **Dynamic Host Configuration Protocol (DHCP)** on the **Dobot M1 IP Address Setting** page and click **Confirm**.

Step 4 Click **Disconnect** on the upper left pane of the M1Studio page.

About 2 seconds later, select the modified IP address from the drop-down list on the upper left pane of the M1Studio page, and click **Connect**.

5.3 System Commissioning

The origin and other settings of Dobot M1 have been set by default, Dobot M1 can be directly put in use. After Dobot M1 is installed and the cables connected are checked, the system commissioning can be performed.

5.3.1 Debugging Dobot M1

Prerequisites

- You have started M1Studio.
- You have connected Dobot M1 to the PC over a serial cable.
- (Optional) You have connected Dobot M1 to the PC over a network cable.
- You have connected Dobot M1 and an emergency stop switch.

Procedure

Step 1 Start Dobot M1. Hold down the power button in the base of Dobot M1 for about 2 seconds, and then release your fingers when the yellow LED indicator is on.

When powering on, the yellow LED indicator in the base is steady on for about 15 seconds, and then blinks once. It is steady on again for about 5 seconds, which indicates that Dobot M1 is being started.

After the yellow LED indicator in the base is off, the green one is steady on for about 5 seconds, and then is blinking, which indicates that Dobot M1 is in service.

NOTICE

When first powering on robotic arm, please check Z-axis or J3 value from M1Studio. If the value is below 10mm, an alarm about limitation is generated and meanwhile the red indicator on the base of robotic arm is on, which is a normal phenomenon. At that point, you need to click **J3+** under Joint coordinate system to jog robotic arm to the position where the J3 value is above 10mm, and then the alarm will be cleared.

Step 2 Select the corresponding serial port from the serial drop-down list, and click **Connect**.

If **Connect** turns to **Disconnect**, the connection is successful, and Dobot M1 can be controlled by M1Studio.

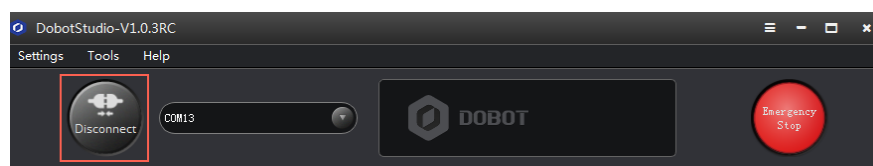

Figure 5.18 The successful Connection

⚠ NOTICE

- You can connect Dobot M1 to a PC over a network cable, then select the corresponding IP address from the serial drop-down list on the M1Studio page and click **Connect**. For details, please see 5.2.4 (Optional) Connecting Network Cable.
- M1Studio can be connected to Dobot M1 only when Dobot M1 is in Dobot Mode. You can check the current mode of Dobot M1 on the **Tools > Web Management** page, as shown in Figure 5.19. For details, please see 6.9 Operating Web Management.

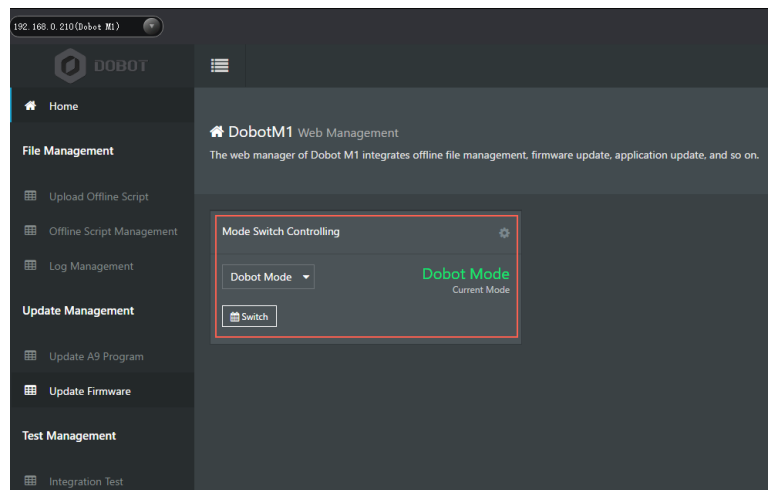

Figure 5.19 Status of Dobot M1

5.3.2 Debugging the Power of Dobot M1

Prerequisites

- You have powered on Dobot M1.
- You have connected Dobot M1 and an emergency stop switch.

Procedure

Hold down the power button in the base of Dobot M1 for about 5 seconds, and then release your fingers. If all LED indicators are off and Dobot M1 moves down automatically, Dobot M1 is powered off successfully.

⚠ NOTICE

You cannot hold down the power button to power off Dobot M1 until Dobot M1 is in the running state (when the green LED indicator is blinking). If Dobot M1 fails to be started, you must force to power off Dobot M1.

5.3.3 Debugging Emergency Stop Function

Prerequisites

- Dobot M1 has been powered on.
- Dobot M1 has been connected to a PC successfully.
- Dobot M1 has been connected to an emergency stop switch.

Procedure

- Step 1** Make Dobot M1 in the running state. For details, please see *6.2 Operating Teaching and Playback*.
- Step 2** Hold down the emergency stop button, to make Dobot M1 in the stopped status, as shown in Figure 5.20.



Figure 5.20 Emergency stop

Dobot M1 is stopped immediately with an alarm about emergency stop and the red LED indicator on the base is on, which indicates that the emergency stop function is OK.

- Step 3** Rotate the emergency stop button clockwise.

The emergency stop button is bumped when rotating to 45°, which indicates the stopped status is cleared.

- Step 4** Double-click the alarm tip generated on the M1Studio page, as shown in Figure 5.21. The **Alarm and Log** page is displayed.

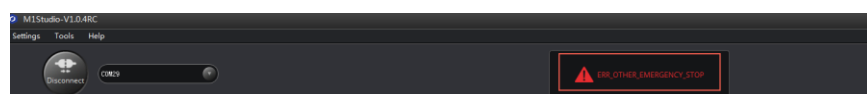

Figure 5.21 Alarm tip

Step 5 Click **Reboot** on the **Dobot M1 Alarm** tab of **Alarm and Log** page to Restart Dobot M1, as shown in Figure 5.22.

If Dobot M1 can be running after rebooting, the stopped status is cleared successfully.

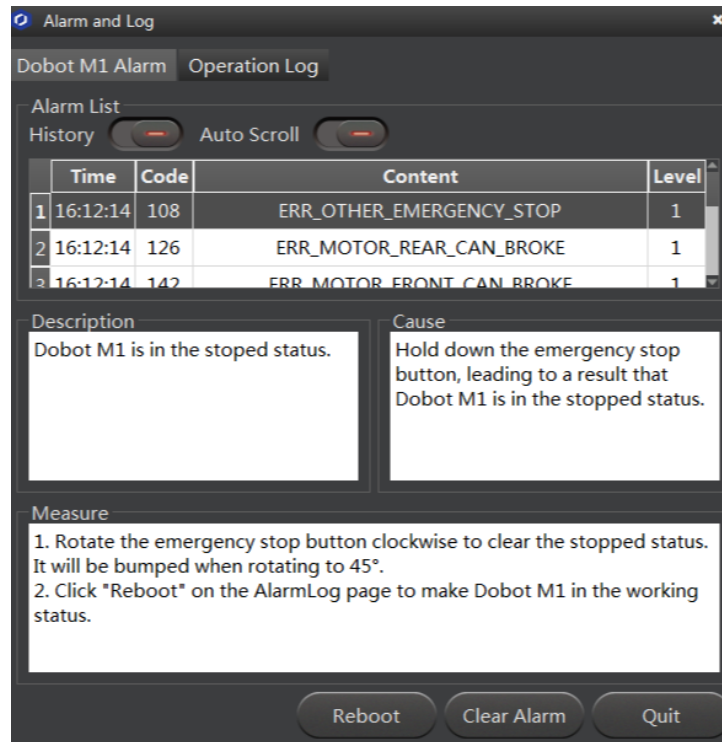

Figure 5.22 Alarm tab

5.3.4 Debugging Disabling Function

You can disable the motor of Dobot M1 to make it in the open-loop state, and then move Dobot M1 by hand.

Prerequisites

- Dobot M1 has been powered on.
- Dobot M1 has been connected to a PC successfully.
- Dobot M1 has been connected to an emergency stop switch.

Procedure

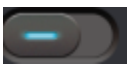
Step 1 Click the  icon of **Motor** on the **Operation Panel** pane of the M1Studio page, as shown in Figure 5.23.

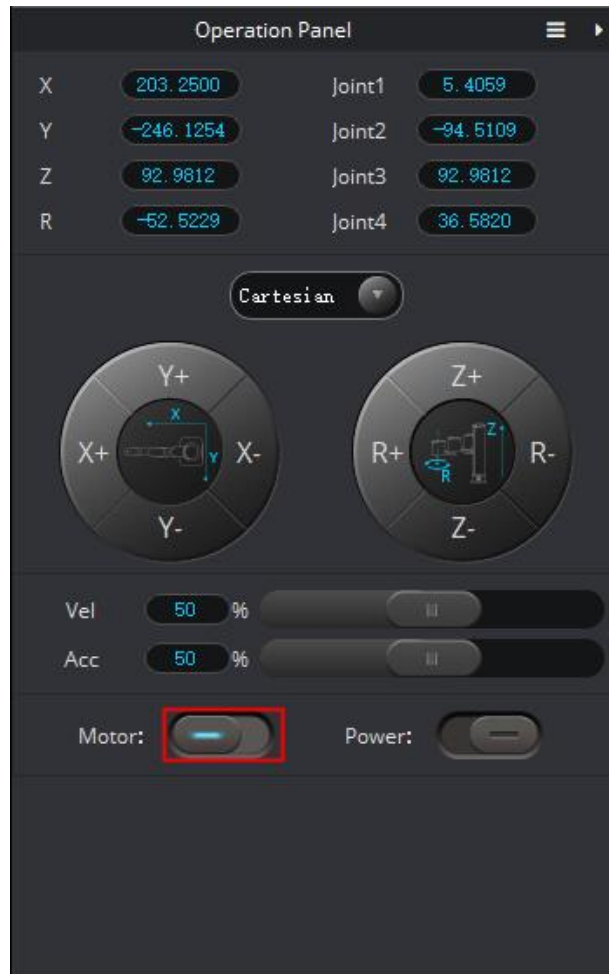
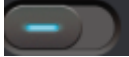
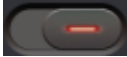

Figure 5.23 Disabling Dobot M1

If  turns to  and Dobot M1 moves down automatically, the motor of Dobot M1 is in the open-loop state.

Step 2 Check whether Dobot M1 can be moved by hand.

If Dobot M1 can be moved by hand, the disabling function is OK.

5.3.5 Debugging Motion Function

For details about motion functions supported by Dobot M1, please see [2.3.4 Motion Function](#).

5.3.5.1 Debugging Jogging Function

Prerequisites

- Dobot M1 has been powered on.
- Dobot M1 has been connected to a PC successfully.
- Dobot M1 has been connected to an emergency stop switch.

Procedure

This section uses Cartesian coordinates as an example to describe how to debug jogging

function. The procedure for debugging Joint coordinates is similar to that for debugging Cartesian coordinates. You need to select **Joint** on the **Operation Panel** page, and then Click **J1+**, **J1-**, **J2+**, **J2-**, **J3+**, **J3-**, **J4+**, and **J4-** to jog Dobot M1.

- Step 1** Select **Cartesian** from Cartesian drop-down list on the **Operation Panel** page.
The Cartesian coordinate pane is displayed.



Figure 5.24 Cartesian coordinate mode

- Step 2** Drag the **Vel** slider on the **Operation Panel** page to change the velocity ratio of the movement when implementing jogging.

The jogging velocity is the maximum velocity multiplying the corresponding percentage.

- Step 3** Drag the **Acc** slider on the **Operation Panel** page to change the acceleration ratio of the movement when implementing jogging.

The jogging acceleration is the maximum acceleration multiplying the corresponding percentage.

- Step 4** Click **X+** on the **Operation Panel** page to make Dobot M1 jog along X-axis in the positive direction. Click **X-** to make Dobot M1 jog along X-axis in the negative

direction.

You can click Y+, Y-, Z+, Z-, R+, and R-, to make Dobot M1 jog along Y, Z, or R in the negative or positive direction.

5.3.5.2 Debugging Playback Function

Prerequisites

- Dobot M1 has been powered on.
- Dobot M1 has been connected to a PC successfully.
- Dobot M1 has been connected to an emergency stop switch.

Procedure

This section uses MOVL mode as an example to describe how to debug playback function. You can choose other modes such as MOVL, MOVJ, ARC, or CIRCLE. For details on how to save point in ARC and CIRCLE mode, please see *6.1.3 Saving Point in ARC Mode*.

Step 1 Jog Dobot M1 to a point according to *5.3.5.1 Debugging Jogging Function*.

Step 2 Select **Playback** on the DobotStudio page.

The **Playback** page is displayed.

Step 3 Select **PTP > MOVJ** on the **Add Motion Command** pane of the **Playback** page.

Step 4 Select **Add At Last** on the **Playback** page.

Step 5 Set **Vel** and **Jerk** on the **Add Motion Command** pane of the **Playback** page, and click **Add Motion Command** to save the point at **Step 1**.

Vel and **Jerk** on the **Playback** page indicate the velocity ratio and the jerk ratio of the movement when implementing playback respectively. The playback velocity is the maximum velocity multiplying the corresponding percentage. The playback jerk is the maximum jerk multiplying the corresponding percentage.

Step 6 Set the pause time of the previous command on the **Add Wait Command** pane of the **Playback** page, and click **Add Wait Command**.

Step 7 Jog Dobot M1 to another point. And save it. For details, see **Step 1 to Step 6**.

Step 8 Click **Start** on the **Playback** page to make Dobot M1 move according to the saved points list.

Also, you can save points by activating **Enable Hand Hold Teach**, the details are as follows.

Step 1 Select **PTP > MOVJ** on the **Add Motion Command** pane of the **Playback** page.

Step 2 Select **Enable Hand Hold Teach**.

The **Add Motion Command** button will be unavailable.

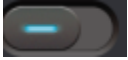
Step 3 Click the  icon of **Motor** on the **Operation Panel** pane of the M1Studio page, to make the motor of Dobot M1 in the open-loop state.

Step 4 Jog Dobot M1 to a point and hold down the button under the Rear Arm to save point.

5.3.6 Debugging Homing Function

After parts (motors, reduction gear units, battery, etc.) have been replaced or robotic arm has

hit the work piece, the origin of Dobot M1 will be changed. You need to set homing point after resetting the origin.

Dobot M1 has installed homing switches near the J1, J2 and J3 limitation position respectively. When Dobot M1 moves to the limit with a signal triggered by the homing switch, Dobot M1 will move backward at low speed and stop moving after separating from the homing switch, which indicates that Dobot M1 has moved to the homing point. At the same time, an alarm about limitation is generated, you need to jog the Joint coordinate to clear the alarm.

NOTICE

Only Dobot M1 of which SN number is *DT2118xxxx* and later numbers has installed the homing switch.

xxx indicates the random number, please replace it based on site requirements.

Prerequisites

- Dobot M1 has been powered on.
- Dobot M1 has been connected to a PC successfully.
- Dobot M1 has been connected to an emergency stop switch.

Procedure

Please select **Tools > Home** on the M1Studio page, and Dobot M1 will move automatically according to the following steps.

- Step 1** J3 moves to the upper limit with a signal triggered by the homing switch, and moves backward at low speed to separate from the homing switch, and then stops moving.
- Step 2** J1 and J2 move to the limit as lefty hand orientation with signals triggered by homing switches of J1 and J2, and move backward at low speed to separate from the homing switches, and then stop moving, indicating that Dobot M1 has moved to the homing point.

After the homing procedure is completed, the coordinate of the homing point is shown as Figure 5.25. If the coordinate you get is quite different from Figure 5.25, it indicates that the homing procedure is failed, please re-execute again.

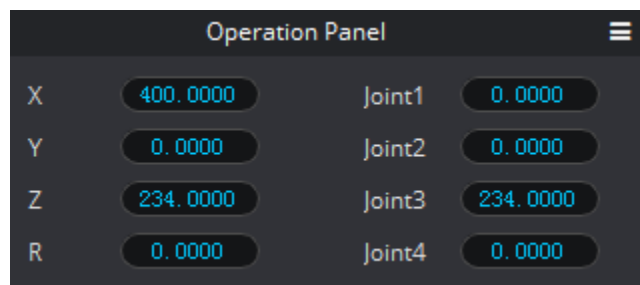

Figure 5.25 Homing point

6. Operation

6.1 Instructions for M1Studio

6.1.1 Module Description

Dobot M1 supports teaching, playback, script control, and Blockly graphic programming. You can use M1Studio to control Dobot M1. Table 6.1 lists the corresponding applications on the M1Studio page.

On the M1Studio page, the **Playback** and **Script** tab are opened by default. If you need to open **Blockly** or **I/O Assistant**, please select the corresponding option on the **Tools** menu of the M1Studio page.

Table 6.1 The module description of M1Studio GUI

Module	Function
Playback	Teach Dobot M1 how to move and then record the movement to make Dobot M1 accomplish the recorded movements.
Blockly	Control Dobot M1 by graphic programming. You can program through a puzzle interface which is intuitive and easy to understand.
Script	Control Dobot M1 by scripting language.
I/O Assistant	Debug the I/O interface that used
Web Management	Execute the saved points lists in offline mode, and upgrade the firmware.

6.1.2 Alarms Description

If teaching or saving point is incorrect, for example, Dobot M1 moves to where a point is at a limited position or a singular position, Dobot M1 will generate an alarm. For details, please see Table 6.2. When an alarm is generated, the red LED indicator on the base will be on.

NOTICE

- Singular point: If the directions of the joint1 and joint2 are collinear, the resultant velocity of joint1 and joint2 is not in any direction, but in the direction of joint1 (joint2). Namely, the degrees of freedom of Dobot M1 are degraded. The singular point is at the position where joint2 is located at $\pm 10^\circ$. In JUMP and MOVJ mode, the movement of Dobot M1 is joint movement, Dobot M1 will not generate an alarm about singular point.
- Generally, if you save a point where an alarm is generated when implementing jogging, the saved point is unavailable. You need to jog Dobot M1 towards the opposite direction under the Joint coordinate system to clear the alarm, and then save the point. However, if an alarm about singular point is generated when

implementing jogging, the saved point is available in JUMP and MOVJ mode.

- In MOVJ or JUMP mode, if the two points are the same, only different in arm orientations, J1 or J4 may be limited when moving Dobot M1, resulting in an alarm generated. You need to modify and resave the point for which the alarm is generated, and then clear the alarm manually.

Table 6.2 Alarm Description

Alarm Condition	Clear method
Jogging	
The Joint coordinate is limited	Jog the limited Joint coordinate towards the opposite direction, and the alarm will be automatically cleared
The Cartesian coordinate is limited	Jog Joint coordinate towards the opposite direction, and the alarm will be automatically cleared
The point is at the singular position when clicking the Cartesian coordinate buttons	Jog joint2, and the alarm will be automatically cleared
Playback	
The starting point or the end point is a singular point in MOVL mode	Clear the alarm manually and modify the point
A point in the trajectory is a singular point in MOVL mode	Clear the alarm manually and modify the point
Modify the arm orientation of the saved point in MOVL mode	Clear the alarm manually and modify the arm orientation
The middle point or the end point is a singular point in ARC mode	Clear the alarm manually and modify the point
A point in the trajectory is a singular point in ARC mode	Clear the alarm manually and modify the point
Any two of the three points of the arc are coincided in ARC mode	Clear the alarm manually and modify the point
The three points of the arc are in a line in ARC mode	Clear the alarm manually and modify the point
The trajectory is out of range of the workspace in all modes	Clear the alarm manually and modify the point
The joint is limited in all modes	Clear the alarm manually and modify the point

The method how to clear the alarm is shown as follows.

Prerequisites

- Dobot M1 has been powered on.

- Dobot M1 has been connected to the PC successfully.
- Dobot M1 has been connected to the emergency stop switch.

Procedure

Step 1 Double-click the alarm tip on the M1Studio page, as shown in Figure 6.1.
The **Alarm Log** is displayed.

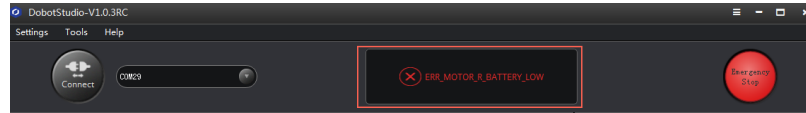

Figure 6.1 Alarm tips

Step 2 View the corresponding alarm on the Dobot Alarm tab. According to **Measure** to clear the alarm, as shown in Figure 6.2.

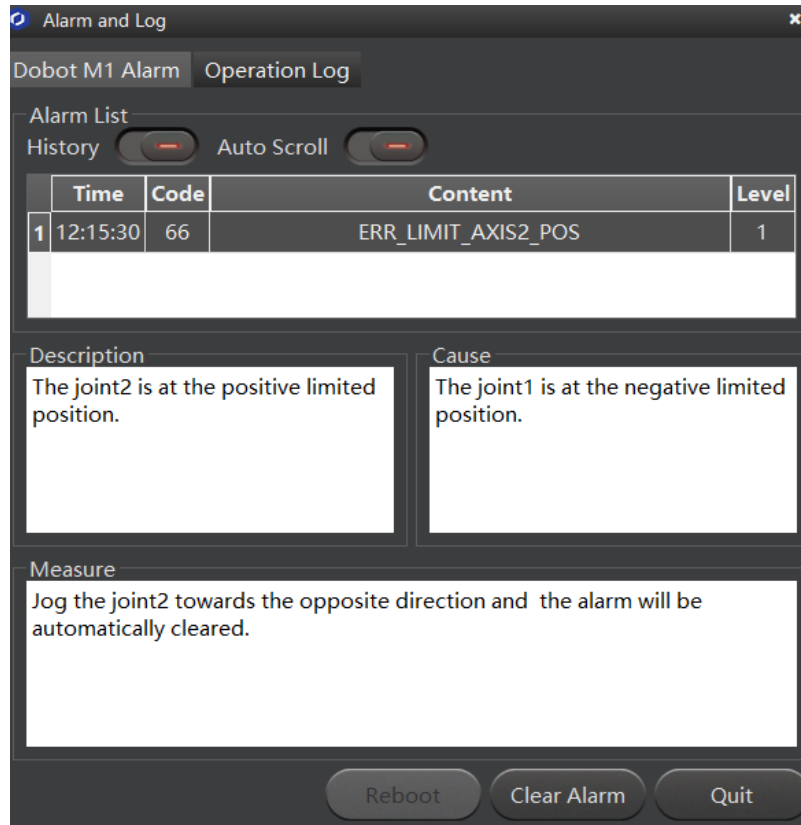

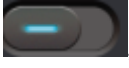
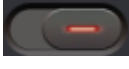

Figure 6.2 Alarm GUI

NOTICE

The button **Reboot** is available only when the alarm is generated about emergency stop.

Table 6.3 shows the description of the alarm button.

Table 6.3 Alarm button description

Button	Description
History	Whether to display the historical alarms. <ul style="list-style-type: none"> <li data-bbox="810 416 1337 495">• If the status of History is , all historical alarms will be displayed. <li data-bbox="810 517 1337 618">• If the status of History is , only the current alarm will be displayed.
AutoScroll	Whether to scroll the alarm information automatically <p data-bbox="810 707 1337 819">If the status of AutoScroll is , the alarm information will be scrolled automatically</p>

Step 3 Click **Clear Alarm** on the bottom pane of the **Dobot M1 Alarm** tab, as shown in Figure 6.2.

If there are no alarm tips on the M1Studio page, the alarm have been cleared.

6.1.3 Saving Point in ARC Mode

Different from PTP, the trajectory of ARC is an arc, you need to save three points to complete the arc trajectory. The method to save points in CIRCLE is the same as that of ARC.

Prerequisites

- Dobot M1 has been powered on.
- Dobot M1 has been connected to the PC successfully.
- Dobot M1 has been connected to the emergency stop switch.

Procedure

NOTICE

You need to use other motion modes to confirm the starting point of the arc trajectory, because the middle point and the end point only can be confirmed in ARC mode. When saving points in ARC, please pay attention to the following tips to avoid generating an alarm.

- Any two of the three points of the arc cannot be coincided
- The three points of the arc cannot be in a line.
- The arc trajectory cannot be out range of the workspace
- The arm orientations in ARC and other mode that confirms the starting point should be the same. Otherwise, Dobot M1 will not work.

If the three points of the arc trajectory are point A, point B, and point C respectively, and point

A is the starting point, point C is the end point, as shown in Figure 6.3.

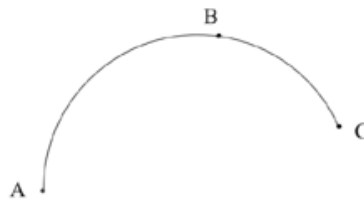

Figure 6.3 Arc trajectory

- Step 1** Select **Cartesian** from Cartesian drop-down list on the **Operation Panel** page, and click the Cartesian coordinate buttons to jog Dobot M1 to a point called point A.
- Step 2** Select **Playback** on the M1Studio page.
The **Playback** page is displayed.
- Step 3** Select **Add At Last** on the **Playback** page.
- Step 4** Select **PTP > MOVJ** on the **Playback** page, and click **Add Motion Command** to save point A.
- Step 5** Click the Cartesian coordinate buttons on the **Operation Panel** page to jog Dobot M1 to another point called point B.
- Step 6** Select **ARC > Transition Pos** on the **Playback** page, and click **Add Motion Command** to save point B.
- Step 7** Click the Cartesian coordinate buttons on the **Operation Panel** page to jog Dobot M1 to another point called point C that is not coincided with point A and point B. The three points are not in a line.
- Step 8** Click **Add Motion Command** to save point C.

 **NOTICE**

You cannot set the pause time when point A moves to point B. Otherwise, Dobot M1 will not work.

- Step 9** Click **Start**, and you will find that Dobot M1 moves as an arc. The information of saved points in ARC is shown as Figure 6.4.

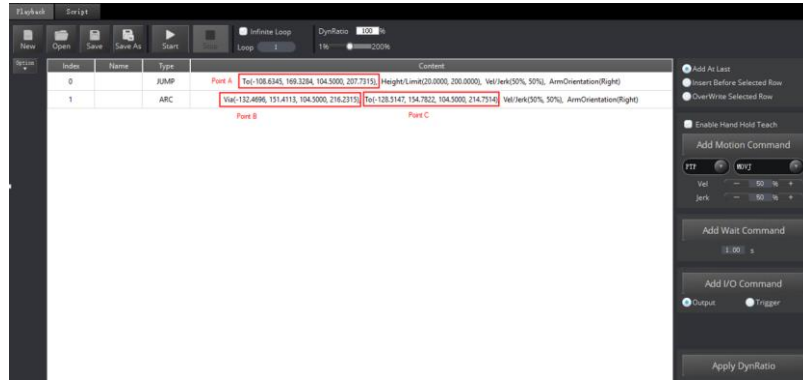

Figure 6.4 Information of saved points in ARC

6.1.4 Saving point in JUMP Mode

From point A to point B in JUMP mode:

- If point A and point B are only different in Z-axis, but the arm orientations of them are the same, Dobot M1 will not work.
- If point A and point B are the same, only different in arm orientations, for example, the arm orientation of point A is left, and that of point B is right, point A moves to point B as the right hand posture, while the terminal coordinate relative to the origin stays constant.

6.2 Operating Teaching and Playback

6.2.1 Basic Operation

Prerequisites

- Dobot M1 has been powered on.
- Dobot M1 has been connected to the PC successfully.
- Dobot M1 has been connected to the emergency stop switch.
- The air pump and the suction cup need to be installed when you suck up objects over teaching and playback. For details on how to connect with air pump, please see 3.4 (Optional) Installing Air Pump.

Application Scenario

If you want to use Dobot M1 to transport, intelligent sort, write and draw, teaching and playback functions of Dobot M1 can help you to complete. This section uses the suction cup as the end effector to describe how to operate.

Procedure



Step 1 Place a small object nearby Dobot M1, choose one of the following three methods to jog Dobot M1 on the small object, called point A. The distance from Dobot M1 to the object should be determined based on site requirements.

- Select **Cartesian** from Cartesian drop-down list on the **Operation Panel** page, and click the Cartesian coordinate buttons.
- Select **Joint** from Cartesian drop-down list on the **Operation Panel** page, and click

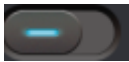
the Joint coordinate buttons.

- Click the  icon of **Motor** on the **Operation Panel** page, and jog Dobot M1 by hand.

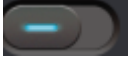
 **NOTICE**

- If you want to jog Dobot M1 by hand when implementing jogging, please click  to make the motor of Dobot M1 in the open-loop state. If you want to move Dobot M1 by clicking the coordinate buttons on the **Operation Panel** page, please click  to make the motor in the close-loop state.
- If an axis is limited or a point is at the singular position when implementing jogging, an alarm will be generated. For details about alarm description, please see Table 6.2 .If you save a point after an alarm is generated, the saved point is unavailable. You need to jog Dobot M1 to clear the alarm, and then save the point again. However, if an alarm about singular point is generated when implementing jogging, the saved point is available in JUMP and MOVJ mode.

Step 2 Select **Add At Last** on the **Playback** page.

Step 3 Select **Playback** on the M1Studio page.

The **Playback** page is displayed.

Step 4 Select **PTP > JUMP** on the **Playback** page, as shown in Figure 6.5. The constraints in JUMP mode are as shown in 6.1.4 *Saving point in JUMP Mode*.

 **NOTE**

The motion mode in this topic is for reference only. You can choose other motion modes based on site requirements. If you use ARC mode, for details on how to saving points in ARC, please see 6.1.3 *Saving Point in ARC Mode*.

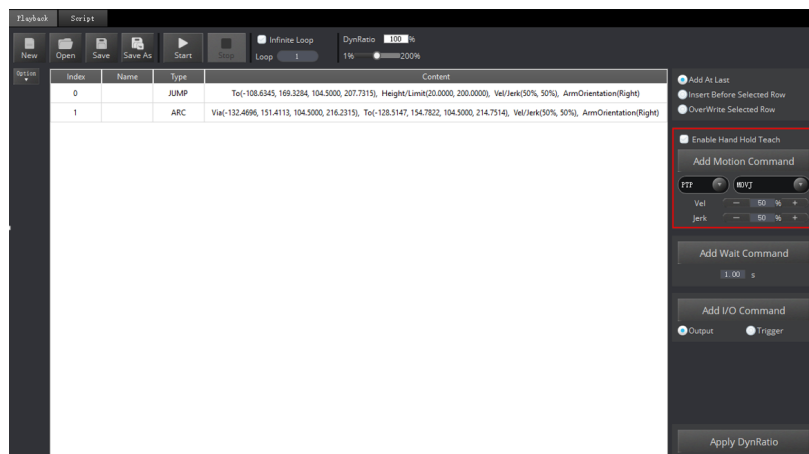

Figure 6.5 Choose motion mode

Step 5 Set the velocity ratio and the jerk ratio of the movement of when implementing playback on the **Add Motion Command** pane of the **Playback** page, and click **Add Motion Command** to save point A. If the values are both set to 50%.

The saved point information of which **Type** is **JUMP** is displayed on the left pane of the **Playback** page, as shown in Figure 6.6.

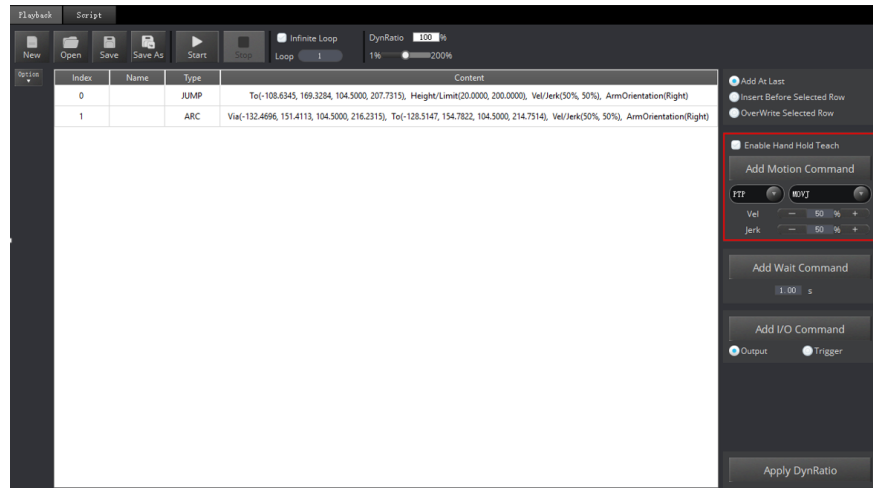

Figure 6.6 The coordinate display

You need to double-click contents displayed in **Content** to set the lifting height (**Height**) and the maximum lifting height (**Limit**) on the current saved point line, of which **Type** is **JUMP**, as shown in Figure 6.7.

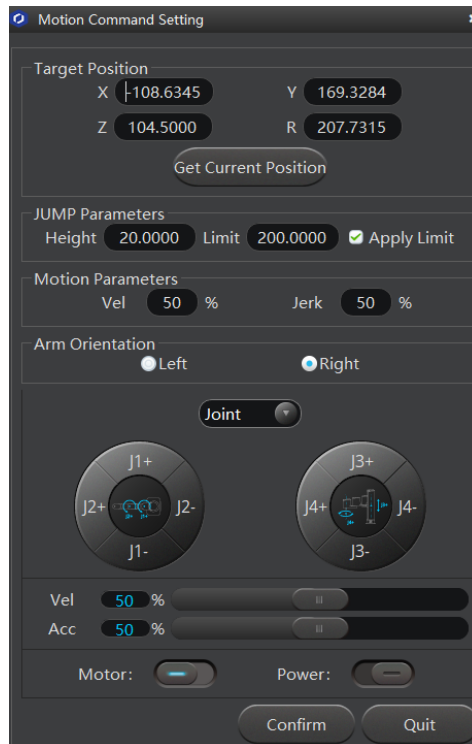

Figure 6.7 Motion command setting

 NOTICE

In JUMP mode, if lifting Dobot M1 to the maximum height is not necessary after lifting to a certain height, please unselect **Use Limit**.

Step 6 Set the pause time of point A on the **Add Wait Command** pane of the **Playback** page, and click **Add Wait Motion**. If the pause time is set to 3 seconds.

The saved point information of which **Type** is **Wait** is displayed on the left pane of the **Playback** page.

Step 7 Suck up the small object over the suction cup.

 NOTICE

Supposing that we use DOUT17, DOUT18 on the base I/O interface to control the state of air pump. DOUT17 control the intake and outtake of air pump. DOUT18 control the startup and shutdown. The description in this topic is for reference only, the outputs depend on the I/O interface used. Please replace the outputs based on site requirements.

1. Select **Output** on the **Add I/O Command** pane of the Playback page.

The saved point information of which **Type** is **Output** is displayed on the left pane of the **Playback** page.

2. Select the saved point of which **Type** is **Output** on the left pane of the **Playback** page, and double-click **Content**.

The **I/O Command Setting** page is displayed.

3. Select **OUT17** from the I/O drop-down list on the **I/O Command Setting** page, and select **24V**, then click **Add**.

4. Add **OUT18**, and select **24V**, then click **OK**.

The relevant I/O information of which **Type** is **Output** is displayed on the left pane of the **Playback** page. Right-click on the line and select **RunSelected** on the context menu, to make the air pump in service, and the object will be sucked up by Dobot M1.

Step 8 Select **Cartesian** from Cartesian drop-down list on the **Operation Panel** page, and click **Z+** to lift Dobot M1. And then click **X+** or other buttons to move Dobot M1 to another point called point B.

Step 9 Save Point B. For details, please see **Step 4** to **Step 6**.

Step 10 Free small object over the suction cup.

 NOTICE

Supposing that we use DOUT17, DOUT18 on the base I/O interface to control the state of air pump. DOUT17 control the intake and outtake of air pump. DOUT18 control the startup and shutdown. The description in this topic is for reference only, the outputs depend on the I/O interface used. Please replace the outputs based on site requirements.

1. Select **Output** on the **Add I/O Command** pane of the **Playback** page.
The saved point information of which **Type** is **Output** is displayed on the left pane of the **Playback** page.
2. Select the saved point of which **Type** is **Output** on the left pane of the **Playback** page, and double-click **Content**.
The **I/O Command Setting** page is displayed.
3. Select **OUT17** from the I/O drop-down list on the **I/O Command Setting** page, and select **24V**, then click **Add**.
4. Add **OUT18**, and select **0V**, then click **OK**.
The relevant I/O information of which **Type** is **Output** is displayed on the left pane of the **Playback** page. Right-click on the line and select **RunSelected** on the context menu, and the object will be freed by Dobot M1.

NOTE

This topics only describes one trajectory as an example. You can implement multiple trajectories. For details, see **Step 1** to **Step 10**.

Step 11 Click **Save** on the **Playback** page.

The **Save Playback File** page is displayed.

Step 12 Input the use-defined name and the saving path, and click **Save**. The default path of the saved points list is *Installation directory*/M1Studio/config/pbstore. Please replace the path based on site requirements.

Step 13 Click **Start** on the **Playback** page, Dobot M1 moves according to the saved points list to suck up or free the object.

6.2.2 Other Function Description

You can perform subsequent operations on the **Playback** page.

- Select **Enable Hand Hold Teach** on the **Playback** page, the **Add Motion Command** button will be unavailable. You can hold down the button under the Rear Arm to save point after jogging Dobot M1 on the **Operation Panel** page or moving Dobot M1 by hand. For details, please see 5.3.5.2 *Debugging Playback Function*.
- Set the loop number of the saved point when implementing playback. The maximum value is 9999. You can also select **Infinite Loop** to make Dobot M1 in the infinite loop state when implementing playback according to the saved points list, as shown in Figure 6.8.

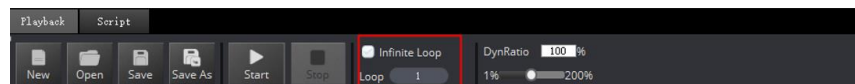

Figure 6.8 The loop number of the saved points list

- Before saving a point, you can select the location of the added point on the right pane of the **Playback** page, as shown in Figure 6.9

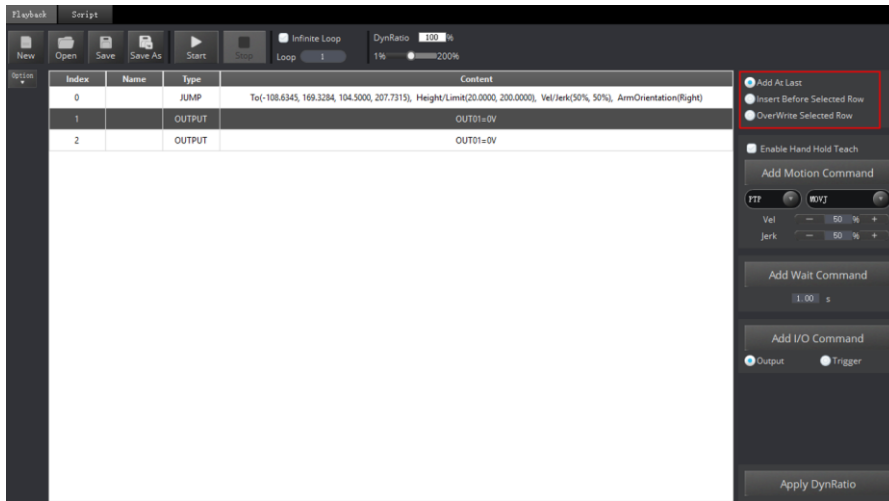

Figure 6.9 Overwrite the current saved point

Table 6.4 lists the location description of a saved point.

Table 6.4 Description of the location of a saved point

Insert Location	Description
Add At Last	Add a new point after the last saved point.
Insert Before Selected Row	Insert a point before the current saved point
OverWrite Selected Row	Overwrite the current saved point

- Select a saved point and double-click the parameters on the line to modify the relevant information. The saved point information is shown as Figure 6.10.

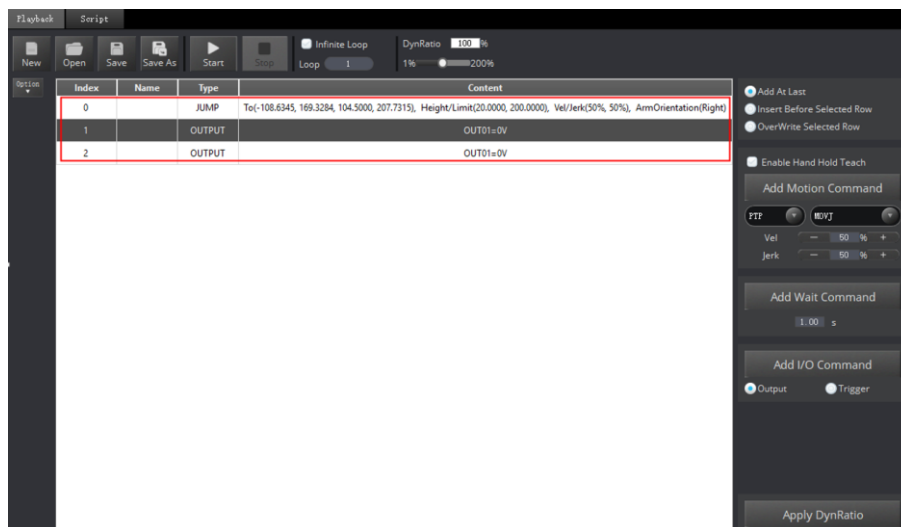

Figure 6.10 The saved point information

Table 6.5 Parameter Description of the saved point

Parameter	Description
Type	<p>The command type of Dobot M1</p> <p>Value:</p> <ul style="list-style-type: none"> • JUMP • MOVJ • MOVL • ARC • CIRCLE: The method to save points in CIRCLE mode is the same as that of ARC mode. For details, please see <i>6.1.3 Saving Point in ARC Mode</i> • TRIGGER • OUTPUT • WAIT
Name	The name of the current saved point, which is user-defined
Content	<p>The contents displayed depends on Type. You can double-click contents displayed in Content to modify them.</p> <ul style="list-style-type: none"> • MOVL/MOVJ/JUMP/ARC/CIRCLE: Indicates the coordinate values, the velocity ratio and the jerk ratio of the movement when implementing playback. <p>If Type of the current saved point is MOVL, ARC, or CIRCLE, Armorientaion must be the same as that of the previous saved point.</p> <p>In MOVL mode, if you modify the arm orientation of the current saved point, an alarm will be generated.</p> <ul style="list-style-type: none"> • Trigger: Input of I/O interface • Output: Output of I/O interface • Wait: The pause time of the previous saved point

- Select a saved point and right-click on the line to copy, delete or other operations, as shown in Figure 6.11.

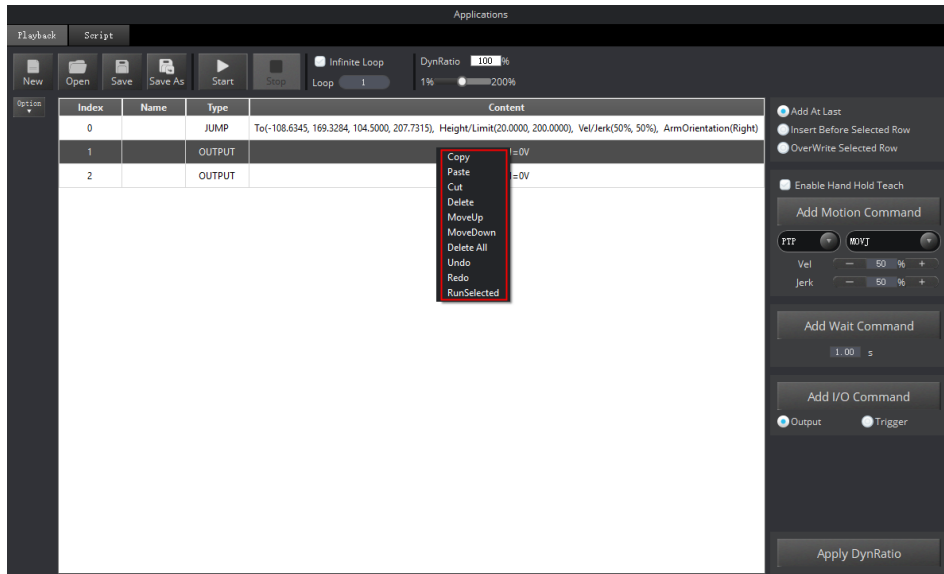

Figure 6.11 Right click options of the saved points list

- When modify the coordinates displayed in **Content** of which **Type** is motion mode, you can input the coordinate values manually or operate the operation panel to modify them.
 1. Select the saved point on the left pane of the **Playback** page, double-click contents displayed in **Content**.

The **Motion Command Setting** page is displayed, as shown in Figure 6.12.

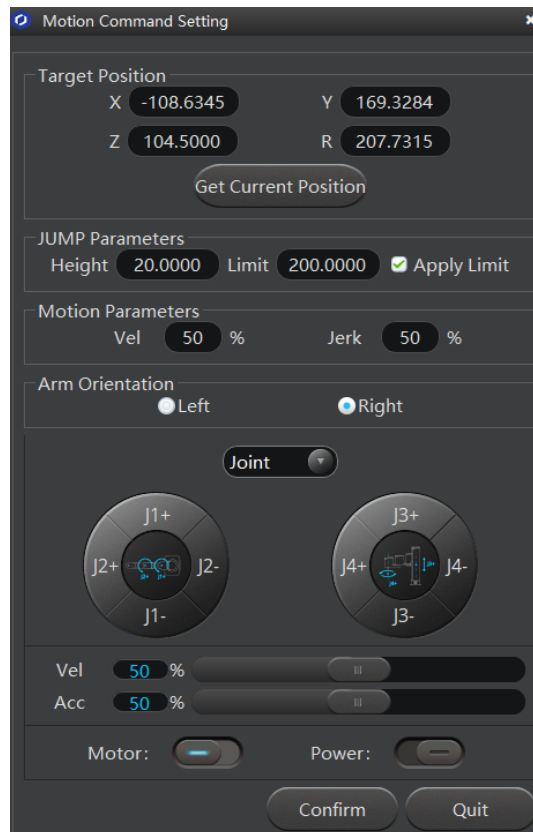

Figure 6.12 Modify the current saved point

2. Click the coordinate buttons on the operation panel pane of the **Motion Command Setting** page to jog Dobot M1. The coordinate is displayed on the **Operation Panel** pane of M1Studio page.
 3. Click **Get Current Pose** to obtain the coordinate of Dobot M1.
 4. Click **Confirm** to save the modified point.
- If modifying the speed of all saved points at the same time is necessary, you can drag **DynRatio** to modify, as shown in Figure 6.13

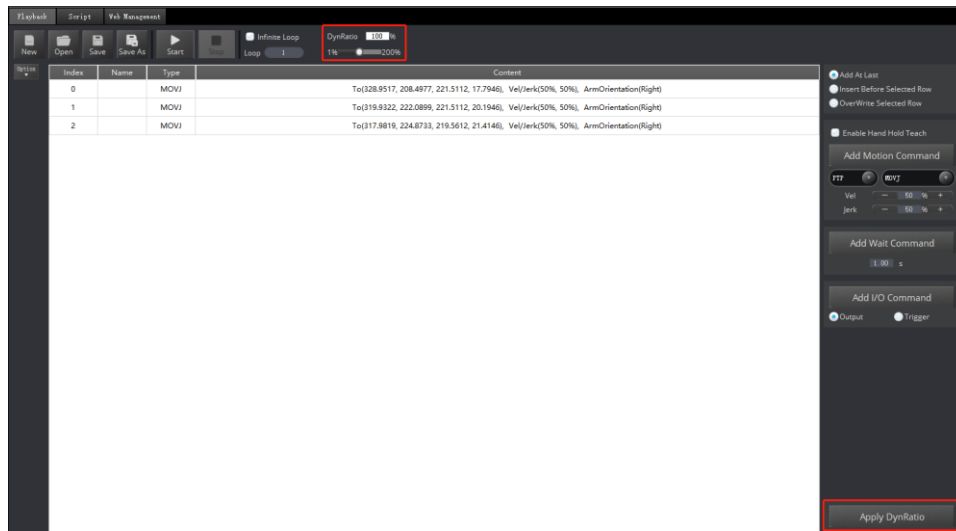

Figure 6.13 Modify the speed of all saved points at the same time

- If you do not click **Apply DynRatio**, the modified speed goes into effect temporarily. **Vel** and **Jerk** displayed on the **Playback** page will not be changed, and the modified speed will not be saved if you click **save**.
- If you click **Apply DynRatio**, **Vel** and **Jerk** displayed on the **Playback** page will be changed, and the modified speed will be saved to Playback files if you click **save**.

6.3 Scripting

Prerequisites

- Dobot M1 has been powered on.
- Dobot M1 has been connected to a PC successfully.
- Dobot M1 has been connected to an emergency stop switch.

Application Scenario

You can control Dobot M1 over scripting. Dobot M1 supports various API, such as velocity/acceleration setting, motion mode setting, and I/O configuration, which uses Python language for secondary development. For details about the Dobot M1 API interface and function description, please see *Dobot API Interface Document*.

The download path is www.dobot.cc/downloadcenter/dobot-m1.html#most-download.

Procedure

Step 1 Select **Script** on the M1Studio page.

The **Script** page is displayed.

Step 2 Write the script.

You can double-click the interface used, the corresponding interface will be displayed on the script file page, as shown in Figure 6.14. You can also click  icon of the corresponding interface on the left pane of the **Script** page to view the way how to set the parameters. The scripting example can refer to *Installation directory/M1Studio/config/ststore/Example.script*.

 **NOTICE**

If you use the motion command when scripting, please add the orientation command before every motion command, which indicates the arm orientation of Dobot M1.

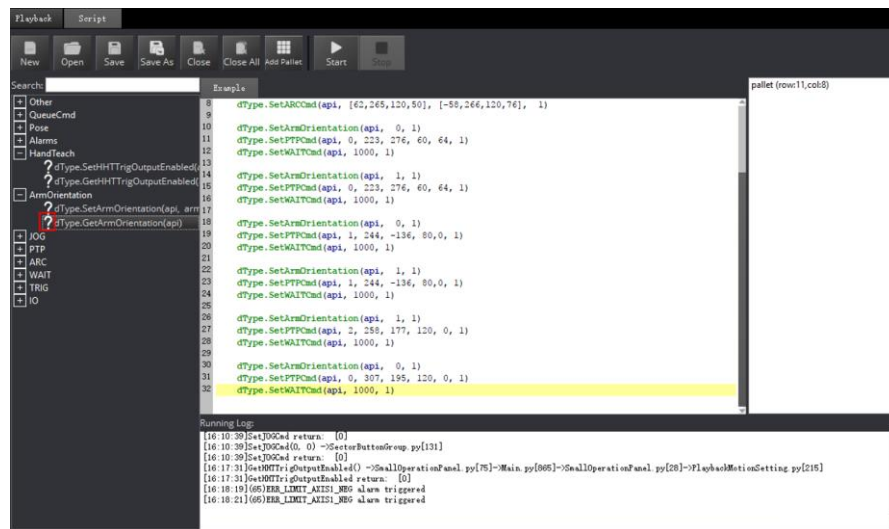

Figure 6.14 Write a script

Step 3 Click **Save** on the **Script** page.

The **Save Scrip File** page is displayed.

Step 4 Input the use-defined name and the saving path, and click **Save**. The default path of the script is *Installation directory/M1Studio/config/ststore*. Please replace the path based on site requirements.

Step 5 Click **Start**, and Dobot M1 will move according to the script file.

The running log will be displayed on the lower pane of the Script page for checking.

6.4 Operating Blockly

Prerequisites

- Dobot M1 has been powered on.
- Dobot M1 has been connected to a PC successfully.

- Dobot M1 has been connected to an emergency stop switch.

Application Scenario

Blockly is a programming platform based on Google Blockly. You can program through the puzzle format, which is straightforward and easy to understand.

Procedure

Step 1 Select **Tools > Blockly** on the M1Studio page.

The **Blockly** page is displayed.

Step 2 Drag the blockly module on the left pane of the **Blockly** page to program, as shown in Figure 6.15.

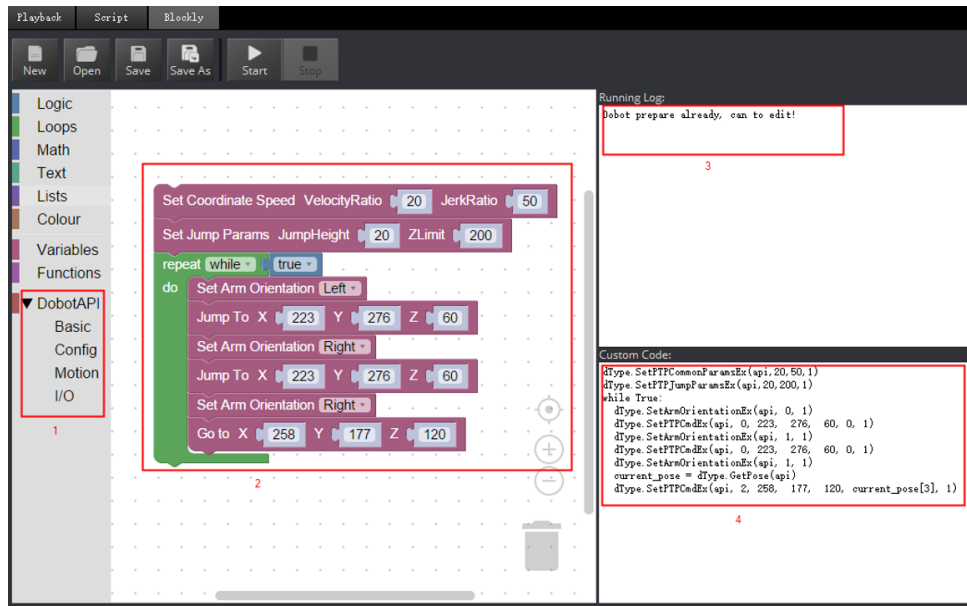

Figure 6.15 Blockly graphic programming

NOTICE

Only MOVL and JUMP modes are supported when programming. If you use the motion command when programming, please add the orientation command before every motion command, which indicates the arm orientation of Dobot M1.

Table 6.6 Description of blockly module

No.	Description
1	The selection area of blockly module, including logistic, loop, math, and Dobot API. You can program by dragging them to the window.
2	The window of blockly programming

No.	Description
3	The running log of Dobot M1
4	The corresponding codes of the blockly module on the programming window

Step 3 Click **Save** on the **Blockly** page.

The **Save Blockly File** page is displayed.

Step 4 Input the use-defined name and the saving path, and click **Save**. The default path of the programing file is *Installation directory***M1Studio/config/bystore**. Please replace the path based on site requirements.

Step 5 Click **Start** on the **Blockly** page, and Dobot M1 will move according to the program.

6.5 Operating Laser Engraving

Prerequisites

- Dobot M1 has been powered on.
- Dobot M1 has been connected to a PC successfully.
- The laser kit has been installed. For details, please see *3.3.1 Installing Laser Engraving Kit*.
- The picture to be engraved and materials to be processed have been prepared.
- The lasing protective eyeglass has been prepared.

Procedure

Step 1 Select **Tools > Laser Engraving** on the M1Studio page.

The **Laser Engraving** page is displayed, as shown in Figure 6.16.

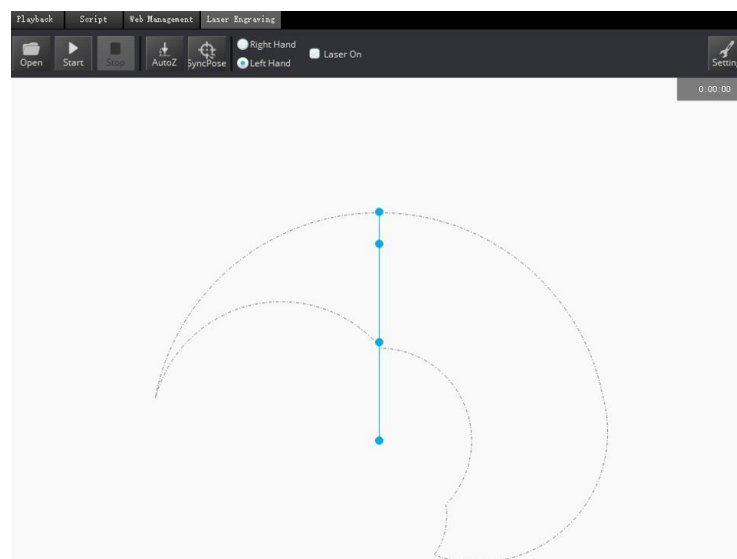

Figure 6.16 Laser Engraving GUI

Step 2 Click **Open** on the Laser Engraving page, and select the picture to be engraved, as shown in Figure 6.17.

The picture (such as BMP, JPEG, JPG, PNG, and so on) is supported.

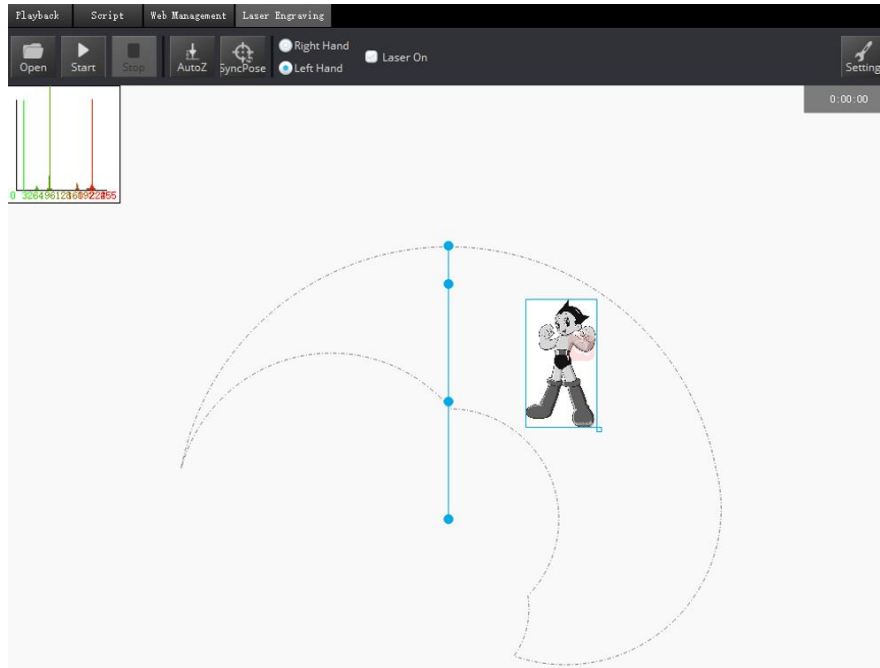

Figure 6.17 Import picture

NOTICE

- The imported picture should be placed in the annular region, as shown in Figure 6.17. If not, it is unable to engrave normally and the border of the imported picture will be highlighted in red.
- The annular region depends on arm orientation. Please adjust the imported picture according to the real annular region. Figure 6.17 shows the annular region when arm orientation is left.

Step 3 Click **Setting** on the Laser Engraving page.

The **Laser Setting** page is displayed.

Please set the laser engraving parameters based on site requirements.

Table 6.7 Laser engraving parameters

Parameter	Description
CP Vel/ CP Acc	Set the rate of CP velocity and acceleration
PTP Vel/ PTP Jerk	Set the rate of PTP velocity and jerk

Parameter	Description
Grayscale Range	Set the grayscale range Value range: 0-255
Laser Power Range	Set the laser power range Value range: 2-100
Laser Height	Set the laser height
Border Width	Set the border width of the picture Value range: 0-50
XBias	Set XBias
DPI	Set DPI

Step 4 Select **Laser On** on the **Laser Engraving** page and adjust focus.

Please wear the lasing protective eyeglass before adjusting focus.

Click the  icon of **Motor** on the **Operation Panel** pane of the M1Studio page and move Dobot M1 by hand to a proper height, to make the laser dot on the material burn the brightest. When the laser power is enough, you can view burn marks on the material.

 **NOTICE**

- Please wear the lasing protective eyeglass before adjusting focal length.
- If the focal length still cannot focus, you can rotate clockwise the focal length of the laser head to adjust, as shown in Figure 6.18.

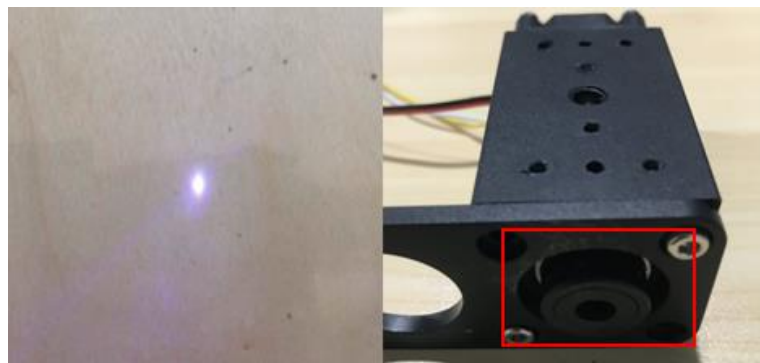

Figure 6.18 Adjust focus

 **DANGER**

- The laser can heat objects when it is in a focused state, so objects like paper or wood

can be burned.

- Do not focus the laser on people or animals.
- Do not let children play with it alone. The process needs to be monitored when it is running. After the process is completed, please turn off the laser promptly.



Step 5 Click the icon of **Motor** on the **Operation Panel** to make Dobot M1 in the open-loop state.

Step 6 Click **AtutoZ** on the **Laser Engraving** page to obtain the current Z-axis value. After performing this step, you will not need to adjust the focus manually when you engrave next time. You can click **SyncPos** directly after importing picture.

Step 7 Click **SyncPos**, Dobot M1 will move into the top position of the starting point automatically.

Step 8 Click **Start** to start engraving.

6.6 Operating 3D Printing

Prerequisites

- Dobot M1 has been powered on.
- You have connected Dobot M1 to a PC over network cable or router, and the IP address of Dobot M1 and the PC must be in the same network segment. For details, please see *5.2.4 (Optional) Connecting Network Cable*.
- You have connected Dobot M1 to a PC over a serial cable.
- Dobot M1 has been connected to an emergency stop switch.
- The 3D printing kit has been installed. For details, please see *3.3.2 Installing 3D Printing Kit*.
- Slice software Cura has been installed. The download path is <https://ultimaker.com/en/products/cura-software/list>.

Please download the recommended version **V14.07**. The way how to install and use is not described in this topic.

- The 3D printing model and the firmware have been prepared.
- The printing platform has been prepared and please place it in the workspace.

NOTICE

If SN number of Dobot M1 is *DT2118xxxx* and later numbers, please switch **3D printing mode** directly to start 3D printing without update. If you need to update 3D printing firmware, please see *6.9.2 Upgrading Firmware*.

xxx indicates the random number, please replace it based on site requirements.

Procedure

Step 1 Select the corresponding IP address from the IP drop-down list on the upper left pane of the M1Studio page and click **Connect**.

If **Connect** turns to **Disconnect**, the connection is successful.

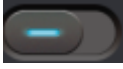
Step 2 Click the  icon of **Motor** on the **Operation Panel**, and move Dobot M1 by hand to make Dobot M1 move to the position where the X-axis value is 330mm.

Step 3 Switch the 3D printing firmware.

1. Select **Tools > Web Management** on the M1Studio page.

The **Web management** page is displayed.

2. Select **Home** in the navigation three on the left.

The **Home** page is displayed.

3. Select **3D printing Mode** from the drop-down list on the **Mode Switch Controlling** pane of the **Home** page and click **Switch**, as shown in Figure 6.19.

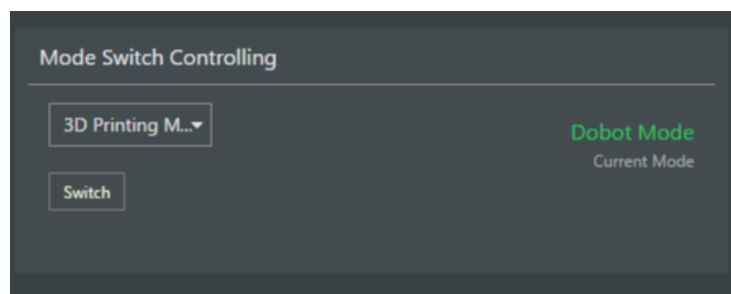

Figure 6.19 Switch 3D printing

During switching, the green LED indicator will keep on. After completion, the green LED indicator will be blinking and **Current Mode** is changed to **3D Printing Mode**, as shown in Figure 6.20.

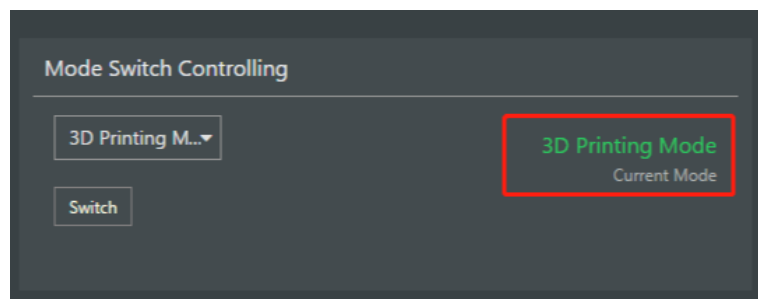

Figure 6.20 Complete 3D printing switching

Step 4 Set slice parameters.

1. Select **Machine > settings** on the Cura page.

The **Machine settings** page is displayed.

2. Set the corresponding parameters on the Machine settings and click **OK**, as shown in Figure 6.21. Table 6.8 lists the values of the parameters that need to be set. The other parameters are set by default.

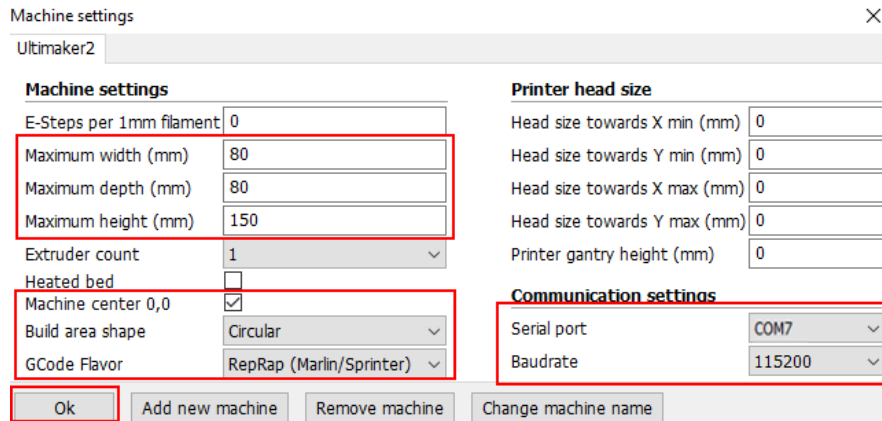

Figure 6.21 Parameters setting

Table 6.8 3D printing parameters description

Parameter	Description
Maximum width	The maximum width please set to 80mm
Maximum depth	The maximum with please set to 80mm
Maximum height	The maximum height Please set to 150mm
Machine center 0,0	Machine center, please select it
GCode Flavor	The style of GCode Please select RepRap Marlin/Sprinter
Build area shape	Build the area shape Please select Circular
Serial port	Serial port Please select the corresponding serial port
Baudrate	Baud rate Please set to 115200

NOTE

The maximum width of 3D printing that Dobot M1 supports is 200mm, the maximum depth is 200mm, and the maximum height is 220mm. Please make 3D-print in the Dobot M1 workspace.

- Set slice parameters, and select **File > Open Profile** to import these parameters,

as shown in Figure 6.22.

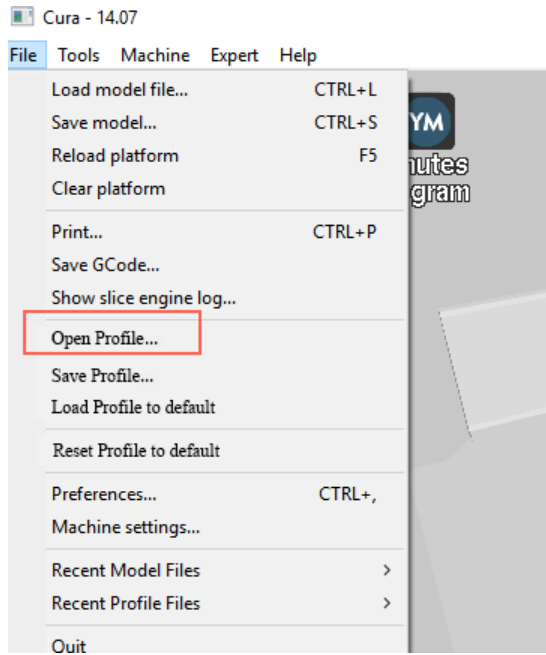

Figure 6.22 Import slice parameters

The 3D printing effect depends on the slice parameters. This topic provides a configuration sample, you can import it directly for printing.

The path of the configuration sample is **Installation directory\M1Studio(Windows)Vxxx\DobotStudio\attachment**, as shown in Figure 6.23.

xxx indicates the version of M1Studio. Please replace it based on site requirements.

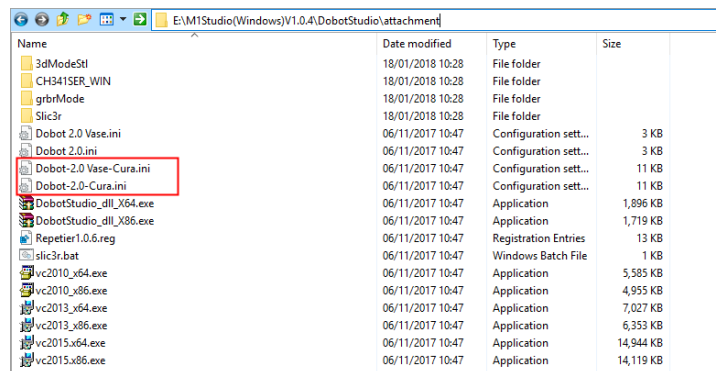



Figure 6.23 Configuration sample

Dobot-2.0-Vase.ini is used for printing a thin-walled vase, while Dobot-2.0.ini is used for the filling, the filling rate is 20%.

4. Click , the **Open 3D model** page is displayed, and select the 3D

printing model prepared.

The format of 3D model is STL. You can design 3D model and transform it into STL format.

After importing the model, click the model itself, you can place it in the middle, zoom or rotate, and so on, as shown in Figure 6.24.

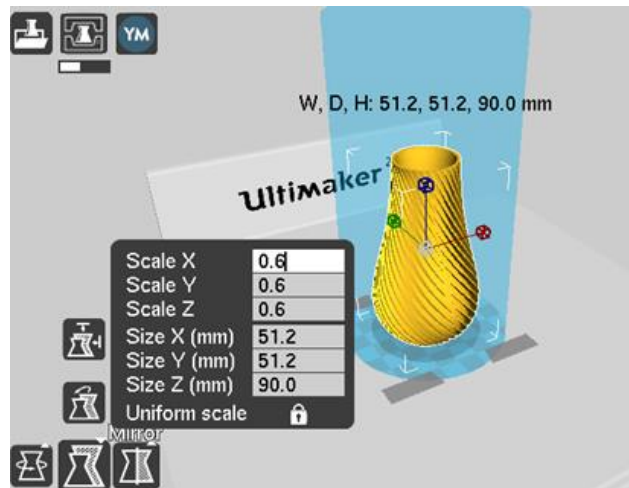

Figure 6.24 Zoom and rotate

5. Click  to connect Dobot M1.

The printing window is displayed and the current printing temperature is shown on the top corner of the window, as shown in Figure 6.25.

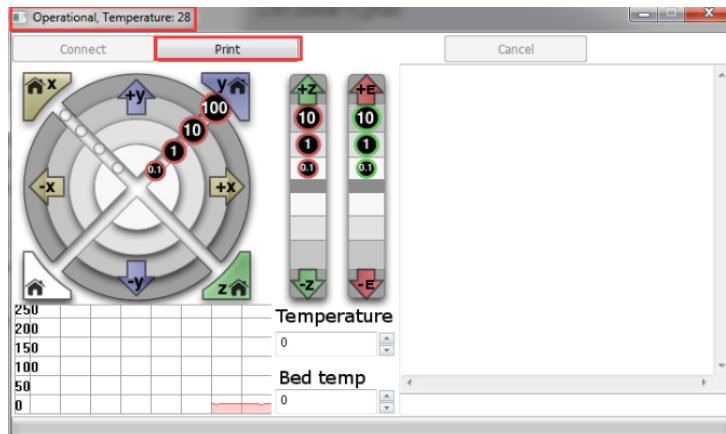

Figure 6.25 Printing window

6. Set **Temperature** to **200** and press down **Enter** to heat the extruder.

The temperature of the extruder should be above 170°C. Dobot M1 will not start 3D printing until the filament is in the melting state. So you need to heat the extruder first.

DANGER

The heating rod will produce high temperature up to 250°C, please be careful. Do not let children play with it alone. The process needs to be monitored when it is running. After the process is completed, please turn off the equipment promptly.

Step 5 Test the extruder.

Before printing, you need to test the extruder to check whether the melted filament flows from the nozzle of the extruder.

Click the feedstock extruder or click the given stepper, such as **10, 1, 0.1** (**10** is recommended) on the **Operational** page and feed up to 10mm-30mm, as shown in Figure 6.26.

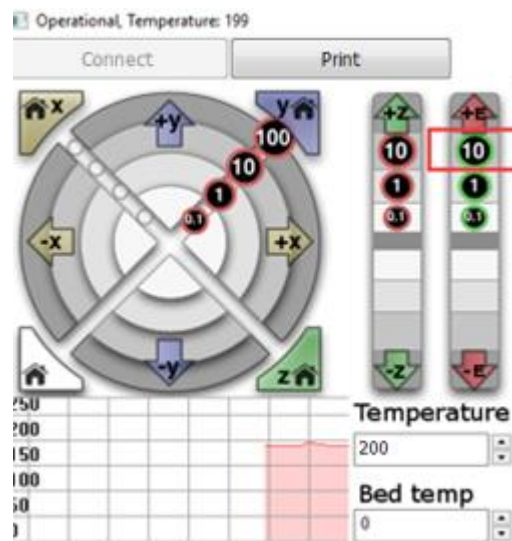

Figure 6.26 Click feedstock extruder

If the melted filament flows from the nozzle of the extruder, the extruder is working properly.

Step 6 Adjust the printing space and get printing coordinates.

1. Click **-Z** or Click **10, 1, 0.1** to move Dobot M1 to the position where the distance from nozzle to the printing platform is about 0.3mm, as shown in Figure 6.27.

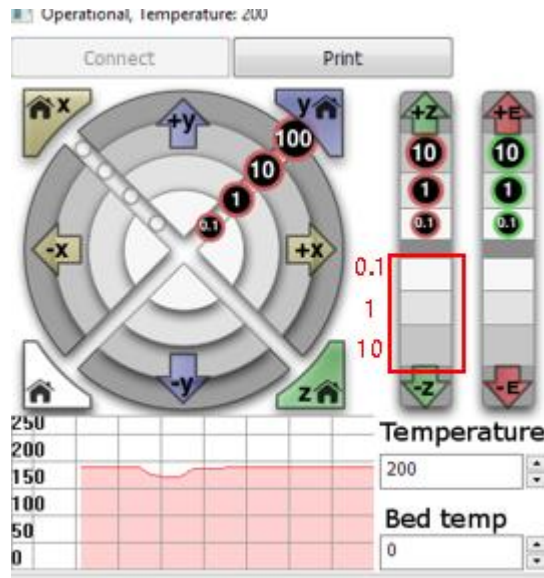

Figure 6.27 Move Z-axis

NOTE

During printing, if the distance from Dobot M1 to the printing platform is too large or too small to paste the first layer, it can lead to the nozzle blockage. For increasing the stickiness of the first layer, placing a masking paper on the platform is recommended.

2. Input command **M415** on the lower right of the **Operational** page to save the printing coordinates, as shown in Figure 6.28.

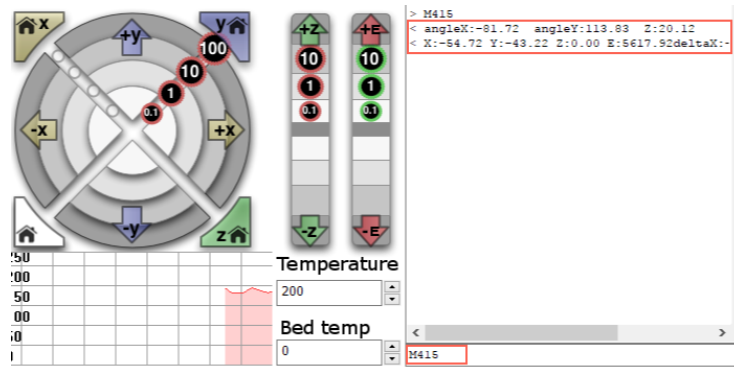

Figure 6.28 Input command M415

Step 7 Click **Print**, Dobot M1 moves to the printing origin (System setting) and starts to print.

NOTICE

If the yellow LED indicator is always on when printing, the connection between Dobot M1 and 3D printing kit is poor. Please check the connection and restart Dobot M1.

6.7 Operating I/O Assistant

Prerequisites

- Dobot M1 has been powered on.
- Dobot M1 has been connected to the PC successfully.
- Dobot M1 has been connected to the emergency stop switch.
- The air pump has been installed (If you use air pump to debug I/O interface).

Application Scenario

The end effectors such as gripper, suction cup need to work with the air pump. The air pump can be controlled by the I/O interface. You can verify the I/O interface and the air pump over **I/O Assistant**.

Procedure

If the air pump is connected to the base I/O interface, the outputs used are DOUT17, DOUT18 respectively. For details, please see 3.4 (Optional) *Installing Air Pump*. The DOUT18 output controls the startup and shutoff of the air pump.

Step 1 Select **Tools > I/O Assistant** on the M1Studio page.

The **I/O Assistant** page is displayed.

Step 2 Click **24V** of **OUT18** on the **Output** pane of the **I/O Assistant** page, as shown in Figure 6.29.



Figure 6.29 I/O assistant

The air pump is humming, which indicates that the air pump is enabled. The working state depends on the air pump. Please judge based on site requirements.

Step 3 Click **0V** of **OUT18** on the **Output** pane of the **I/O Assistant** page

The air pump is not humming, which indicates that the air pump is disabled.

6.8 Operating Collision Detection

Collision detection is mainly used for reducing the impact on the robot arm, to avoid damage

to the robot arm or external equipment. If the collision detection is activated, robot arm will stop running automatically when robot arm hit an obstacle.

NOTICE

If you need to activate collision detection, please make sure that the M1Studio version is **V1.1.6** or later and the A9 firmware version is **a9_app-0057** or later. If not, please download the right version from www.dobot.cc/downloadcenter/dobot-m1.html#most-download.

Prerequisites

- Dobot M1 has been powered on.
- Dobot M1 has been connected to a PC successfully.
- Dobot M1 has been connected to an emergency stop switch.

Procedure

Step 1 Obtain kinetic parameters of each joints of robot arm, to avoid false collision detection.

1. Remove the fixture on the robot arm and make sure that there are no obstacles within the workspace.

If there is no fixture on the robot arm, please skip this step.

2. Select **Tools > SafeSetting...** on the M1Studio page.
The **Safe Mode Setting** page is displayed.
3. Set **Change Level** to **Low**, **PlayLoad** to **0**, select **EX Force Restart** and click **Save**, as shown in Figure 6.30.

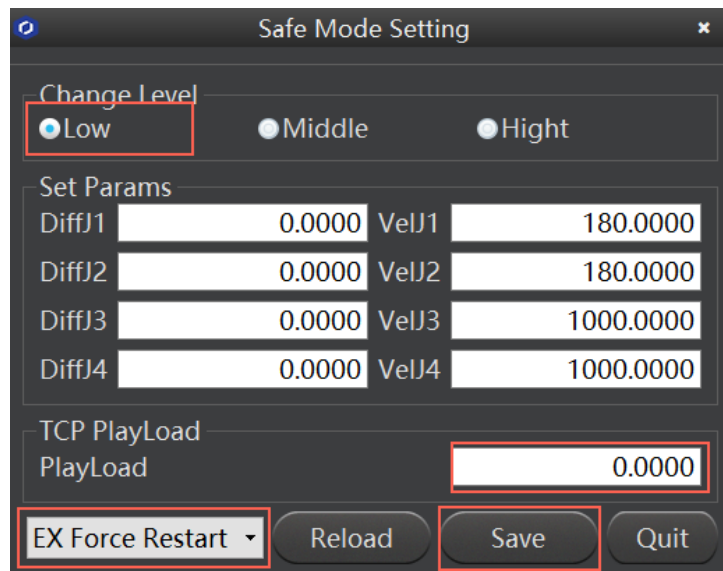

Figure 6.30 Set collision detection parameters

4. Select **Tools > DynamicSetting...** on the M1Studio page.

The **Dynamic Setting** page is displayed.

5. Be sure to understand the precautions shown on the **Dynamic Setting** page and then click **Start**.

After the process bar is 100%, the kinetic parameters will be obtained automatically, as shown in Figure 6.31.

If the kinetic parameters you get is quite different from Figure 6.31, please re-execute **1 - 5** since the obtained kinetic parameters are wrong.

NOTICE

- When obtaining kinetic parameters, robot arm will move in random directions for a while. Please make sure that there are no obstacles within the workspace, to avoid obtaining wrong kinetic parameters because of collision.
- During robot arm running, please do not perform any other operation on Dobot M1 or power off Dobot M1, to avoid Dobot M1 in abnormal condition
- When the unexpected occurs during robot arm running, please click **Stop** on the **Dynamic Setting** page.

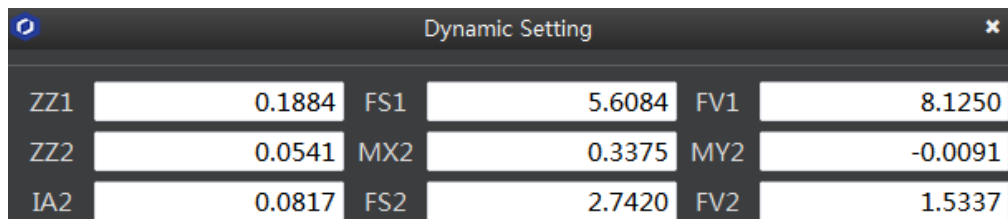

Dynamic Setting					
ZZ1	0.1884	FS1	5.6084	FV1	8.1250
ZZ2	0.0541	MX2	0.3375	MY2	-0.0091
IA2	0.0817	FS2	2.7420	FV2	1.5337

Figure 6.31 Obtain kinetic parameters

6. Click **Save and Quit**.

The kinetic parameters are saved in the main controller.

Step 2 Fix the fixture on the Dobot M1 based on site requirements.

Step 3 Select **Tools > SafeSetting...** on the M1Studio page.

The **Safe Mode Setting** page is displayed.

Step 4 Set the sensitivity level of the collision detection. In this topic, we set **Middle**.

At this point, the parameters in the **Set Params** section will be generated automatically as the set sensitivity level, as shown in Figure 6.32. The details of these parameters are listed in Table 6.9.

NOTICE

The parameters in the **Set Params** section are only effective for horizontal collision detection. Please DO NOT modify these parameters at will. If the vertical collision detection is required, please modify **DiffJ3** to any value in the range from 40 to 50 and remain the rest unchanged.

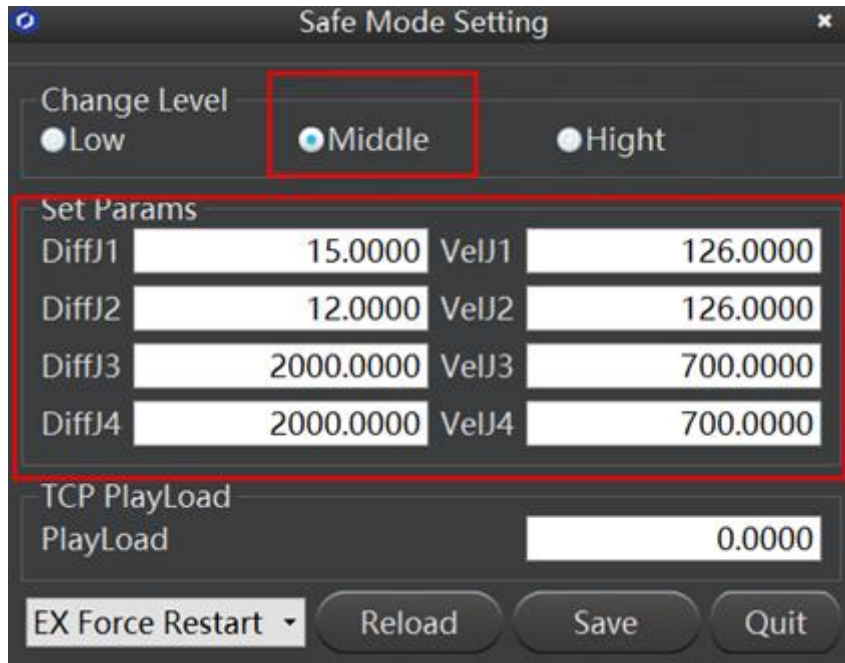

Figure 6.32 Set sensitivity level

Table 6.9 Collision detection Parameters description

Parameter	Description
Low	No restrict. Namely, deactivate collision detection
Middle	Activate collision detection and the speed decreases 30%
High	Activate collision detection and the speed decreases 50%

Step 5 Set the payload based on site requirements. In this topic, we set 1, as shown in Figure 6.33.

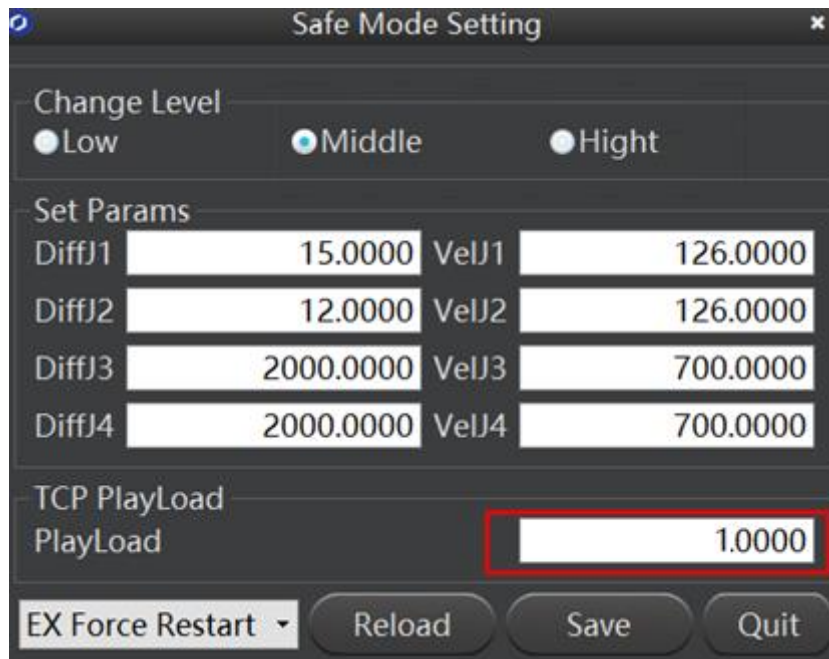

Figure 6.33 Set payload

Step 6 Set post-collision measure. In this topic, we set to **EX Force Restart**.

Table 6.10 Post-collision measure description

Parameter	Description
EX Force Restart	Dobot M1 continues the current task by the external force (Horizontal)
5s Restart	Dobot M1 continues the current task automatically after 5 seconds

Step 7 Click **Save** and then click **Quit**.

Step 8 Restart Dobot M1 to make the collision detection parameters effective.

Step 9 Verify whether the collision detection is effective.

When Dobot M1 hit an obstacle during running, Dobot M1 stops running automatically. If you touch the Dobot M1, Dobot M1 runs again, indicating that the setting is effective.

Abnormal Handling

After the collision detection is activated, if the collision detection is unexpected or the related alarm is triggered, please re-obtain the kinetic parameters.

6.9 Operating Web Management

The web management of Dobot M1 integrates offline file management, firmware update, and application update, which is used to upload the offline files, make Dobot M1 in offline mode, and

update the applications.

6.9.1 Managing Offline File

You can upload the scripts, the blockly programs, or the saved points lists that have been saved on a local PC to Dobot M1 using the web management, to perform offline operation.

After making Dobot M1 in offline mode using the web management, Dobot M1 will be disconnected from M1Studio. You need to switch the operation mode of Dobot M1 using the web management.

Prerequisites

- You have started M1Studio.
- You have connected Dobot M1 to a PC over network cable or router, and the IP address of Dobot M1 and the PC must be in the same network segment. For details, please see *5.2.4(Optional) Connecting Network Cable*.
- You have powered on Dobot M1.
- You have saved the scripts, the blockly programs, or the saved points lists.
- Dobot M1 has been connected to an emergency stop switch.

Application Scenario

If Dobot M1 need to be running in offline mode, please use the web management.

Procedure

- Step 1** Select the corresponding IP address from the IP drop-down list on the upper left pane of the M1Studio page.
- Step 2** Select **Tools > Web Management** on the M1Studio page.
The **Web Management** page is displayed.
- Step 3** Select **Offline Script Management** in the navigation tree on the left.
The **Offline Script Management** page is displayed.
- Step 4** Click **Add File**.
The **Add File** page is displayed.
- Step 5** Click **Select Upload File**.
The uploaded file dialog box is displayed, as shown in Figure 6.34.

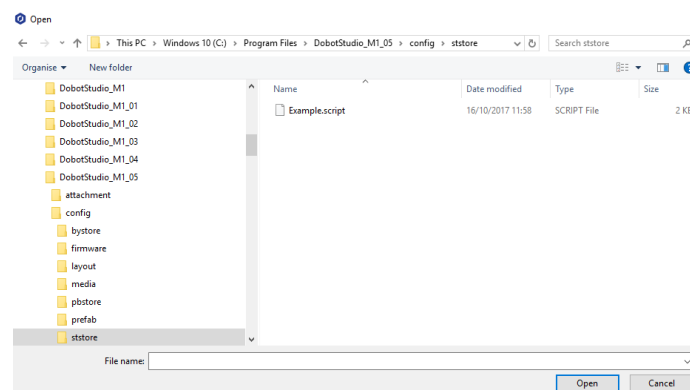

Figure 6.34 Upload files

Step 6 Select files which need to be offline executed in the folder that contains offline files, and click **Open**.

Only support the files, of which the suffixes are .playback, .blockly, and .script.

Step 7 Click **Upload**. You can view the status, as shown in Figure 6.35.

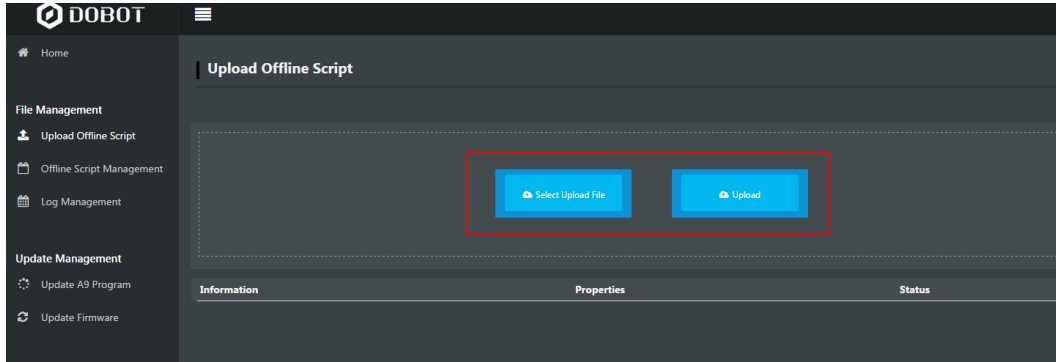

Figure 6.35 Status of Uploading

Step 8 Select the uploaded files that need to be offline executed on the **Offline Script Management** page, and click **Offline** to make the files in offline mode, as shown in Figure 6.36.

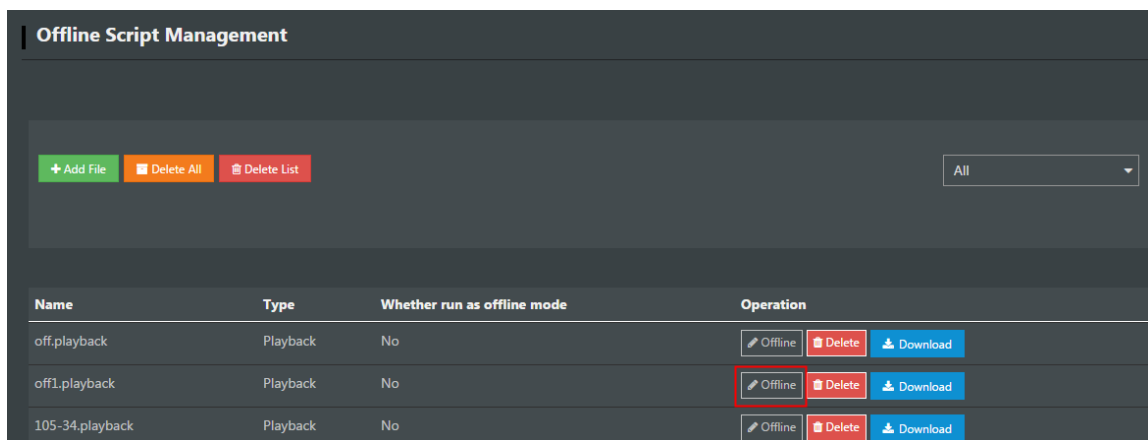

Figure 6.36 Status of the uploaded files

Step 9 Select **Home** in the navigation three on the left.

The **Home** page is displayed.

Step 10 Select **Offline Mode** from the drop-down list on the **Mode Switch Controlling** pane of the **Home** page, and click **Start** to make Dobot M1 in the **Offline Mode** status, as shown in Figure 6.37. Dobot M1 is disconnected from M1Studio, and Dobot M1 can be running according to the files that are in offline mode.

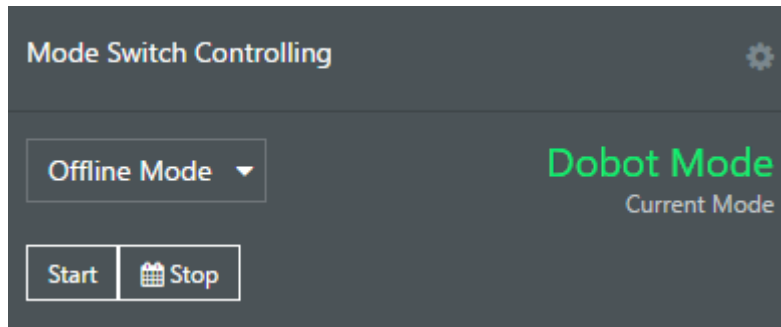

Figure 6.37 Status of Dobot M1

6.9.2 Upgrading Firmware

When the firmware or other applications need to be upgraded, you can use the web management to upgrade the firmware or the application. For example, if you want to use the collision detection or IP address forced configuration function, you can upgrade Dobot M1 firmware.

DANGER

When updating firmware, please do not perform any other operation on Dobot M1 or power off Dobot M1, to avoid Dobot M1 in abnormal condition. Otherwise, it will be vulnerable to injury the device or the person.

Prerequisites

- You have connected Dobot M1 to a PC over network cable or router, and the IP address of Dobot M1 and the PC must be in the same network segment. For details, please see *5.2.4(Optional) Connecting Network Cable*.
- You have powered on Dobot M1.
- You have obtained the latest A9 firmware **a9_app-00xx.tar**. *xx* indicates the firmware version, please replace it based on site requirements.

The download path is <https://www.dobot.cc/downloadcenter/dobot-m1.html#most-download>.

- You have connected Dobot M1 to an emergency stop switch.
- You have obtained the latest M1Studio.

The download path is <https://www.dobot.cc/downloadcenter/dobot-m1.html#most-download>.

Procedure

- Step 1** Select the corresponding IP address from the IP drop-down list on the upper left pane of the M1Studio page.
- Step 2** Select **Tools > Web Management** on the M1Studio page.
The **Web Management** page is displayed.

Step 3 Select **Update A9 Program** in the navigation tree on the left.

The **Update A9 Program** page is displayed, as shown in Figure 6.38.

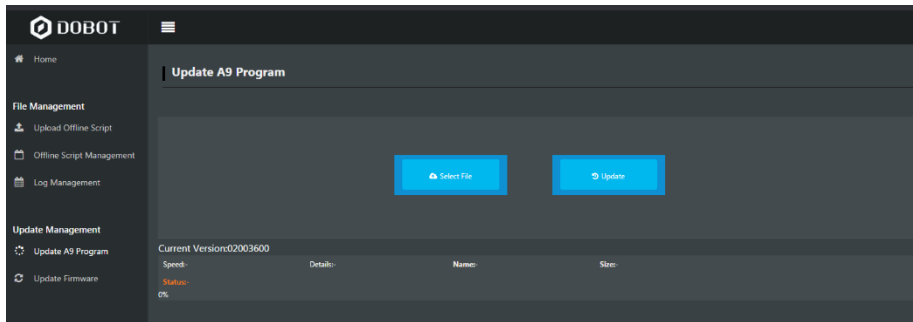

Figure 6.38 A9 Program GUI

Step 4 Click **Select File** and upload the obtained firmware.

Step 5 Click **Update**.

NOTICE

If the version of the obtained firmware is **0058** or later, please click **Update** again after **Status** is **100%**, to avoid update failure.

Step 6 Right-click **Reload** after **Status** is **Update Finish**, as shown in Figure 6.39.

If the A9 firmware version changes to the updated version, it indicates that the update is successful.

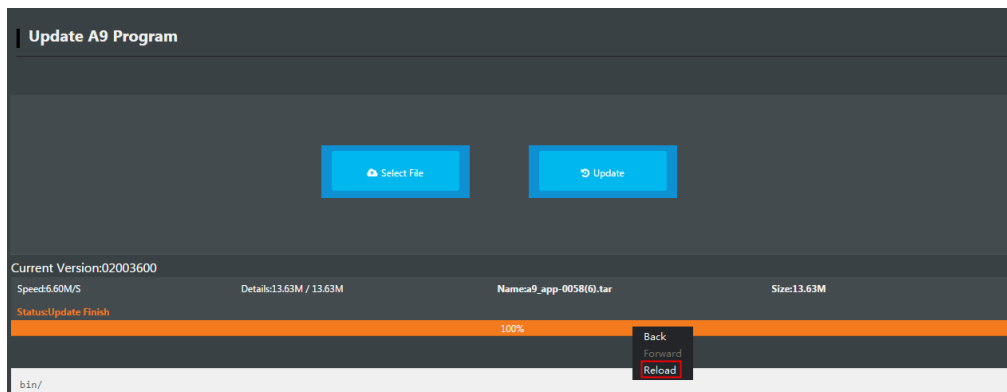

Figure 6.39 Update A9 firmware

Step 7 Restart Dobot M1.

Step 8 Select **Update Firmware** in the navigation tree on the left.

The **Update Firmware** page is displayed, as shown in Figure 6.40.

Update Type	Properties	IsLastVersion	Status	Operation
Dobot Firmware-Size-	Speeds-Details-	IsLast	Wait for uploading	One-click Update
3D Printing Firmware-Size-	Speeds-Details-	IsLast	Wait for uploading	One-click Update
Driver1-Size-	Speeds-Details-	IsLast	Wait for uploading	One-click Update
Driver2-Size-	Speeds-Details-	IsLast	Wait for uploading	One-click Update
Driver3-Size-	Speeds-Details-	IsLast	Wait for uploading	One-click Update
Driver4-Size-	Speeds-Details-	IsLast	Wait for uploading	One-click Update
EndEffector-Size-	Speeds-Details-	IsLast	Wait for uploading	One-click Update
All Drivers-Size-	Speeds-Details-	Waiting	Wait for uploading	One-click Update

Figure 6.40 Update Firmware GUI

Step 9 Select firmware exactly as the order shown in Figure 6.41 and click **One-click Update**.

Update Type	Properties	IsLastVersion	Status	Operation
Dobot Firmware-Size-	Speeds-Details-	IsLast	Wait for uploading	1 One-click Update
3D Printing Firmware-Size-	Speeds-Details-	IsLast	Wait for uploading	4 One-click Update
Driver1-Size-	Speeds-Details-	IsLast	Wait for uploading	One-click Update
Driver2-Size-	Speeds-Details-	IsLast	Wait for uploading	One-click Update
Driver3-Size-	Speeds-Details-	IsLast	Wait for uploading	One-click Update
Driver4-Size-	Speeds-Details-	IsLast	Wait for uploading	One-click Update
EndEffector-Size-	Speeds-Details-	IsLast	Wait for uploading	2 One-click Update
All Drivers-Size-	Speeds-Details-	Waiting	Wait for uploading	3 One-click Update

Figure 6.41 Update order

You can view the process of the firmware upgrade. If the progress bar is 100% and the green LED indicator on the base of Dobot M1 is blinking, the update is completed, as shown Figure 6.42 and Figure 6.43. And then the next firmware update can be started.

Update Type	Properties	IsLastVersion	Status	Operation
Dobot Firmware-Size-	Speeds-Details-	IsLast	Update Finish 100%	One-click Update

Figure 6.42 Process of the firmware upgrade

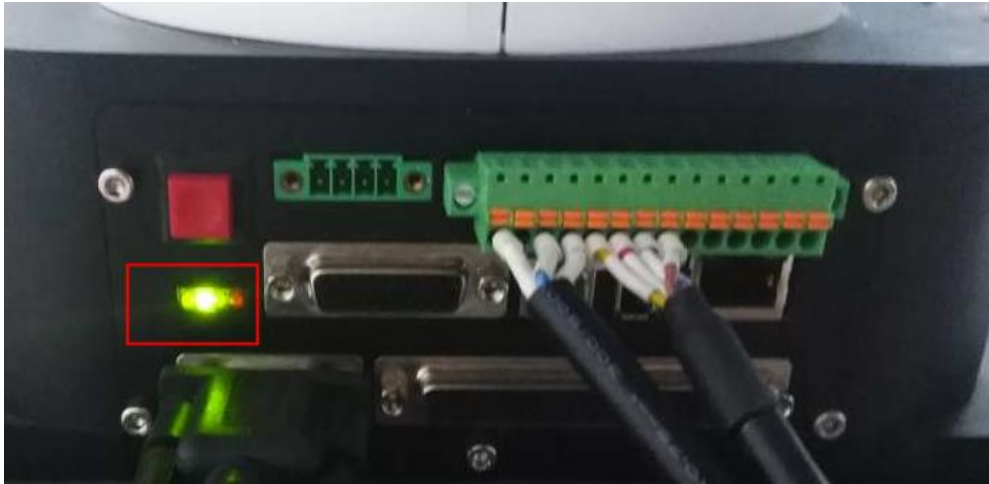

Figure 6.43 LED indicator status

⚠ NOTICE

- Please update firmware exactly as the order shown in Figure 6.41 and the next firmware update should not be started until the current one is completed. Otherwise, the update will fail.
- When updating firmware, please do not perform any other operation on Dobot M1 or power off Dobot M1, to avoid Dobot M1 in abnormal condition. Otherwise, it will be vulnerable to injury the device or the person.

Step 10 Select **3D Printing Mode** from the drop-down list on the **Mode Switch Controlling** pane of the **Home** page, as shown in Figure 6.44.

After the 3D printing firmware is updated, Dobot M1 will switch to 3D printing mode, you need to switch Dobot M1 to Dobot mode. Otherwise, Dobot M1 cannot work normally.

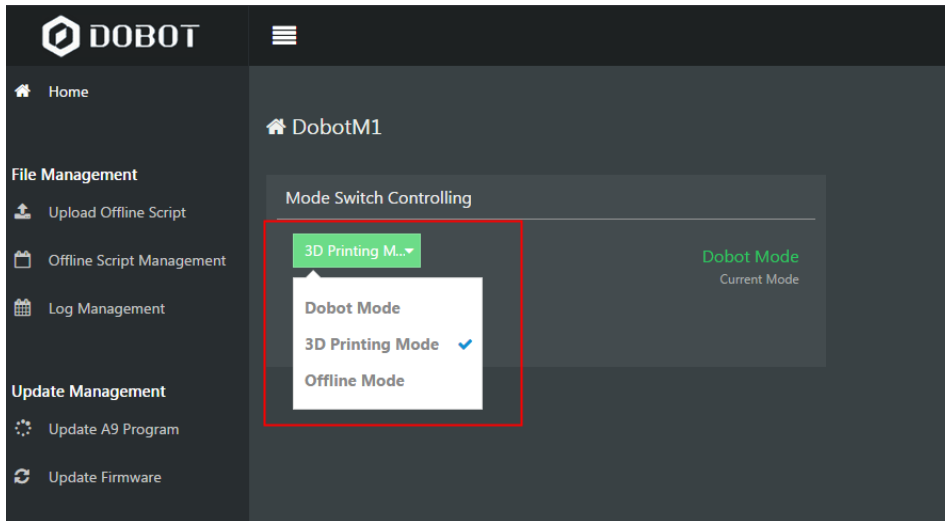

Figure 6.44 Mode switch

6.10 Example

6.10.1 Example of the Trajectory

This topic describes how to use the motion modes according to the real trajectory when Dobot M1 is running.

Figure 6.45 shows the real trajectory when Dobot M1 is running. Figure 6.46 shows the coordinates of the trajectory.

NOTICE

This topic only describes the motion modes that need to be used and precautions for implementing playback, without details about the trajectory. For details on how to implement playback, please see *6.2 Operating Teaching and Playback*.

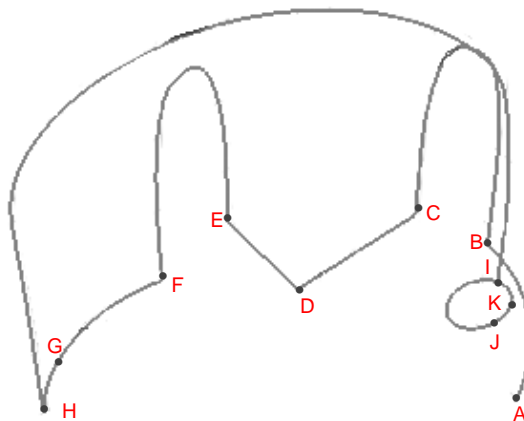

Figure 6.45 Trajectory of Dobot M1

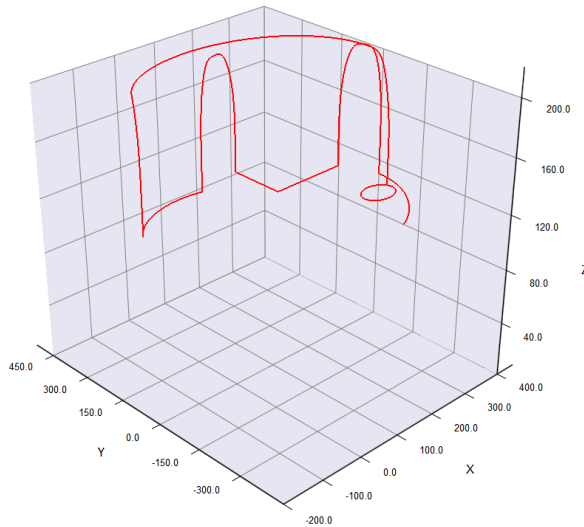

Figure 6.46 Cartesian coordinate of the trajectory

If point A is the starting point, and Point B is the end point. From Point A to Point J, the coordinates are listed as Table 6.11.

Table 6.11 Cartesian coordinates

Point	Coordinate (x,y,z,r)
A	(270,-244,110,0)
B	(400,0,110,0) (Singular point)
C	(366,111,110,0)
D	(194,111,110,0)
E	(194,277,110,0)
F	(85,250,110,0)
G	(-44.4458,239.5284,110,33.08) (The middle point of the arc)
H	(-120.6913,164.5902,110,65.6601)
I	(372.225,-63.2786,110, -148.8402)
K	(351.7533,-113.7360,110, -160.2802) (The middle point of the circle)
J	(323.1731,-115.7006,110, -170.5002)

Figure 6.47 shows the example of the saved points list.

Index	Name	Type	Content
0		MOVJ	To(270.0000, -244.0000, 110.0000, 0.0000), Vel/Jerk(100%, 100%), ArmOrientation(Right)
1		MOVJ	To(400.0000, 0.0000, 110.0000, 0.0000), Vel/Jerk(100%, 100%), ArmOrientation(Right)
2		JUMP	To(366.0000, 111.0000, 110.0000, 0.0000), Height/Limit(20.0000, 200.0000), Vel/Jerk(100%, 100%), ArmOrientation(Right)
3		MOVL	To(194.0000, 111.0000, 110.0000, 0.0000), Vel/Jerk(100%, 100%), ArmOrientation(Right)
4		MOVL	To(194.0000, 277.0000, 110.0000, 0.0000), Vel/Jerk(100%, 100%), ArmOrientation(Right)
5		JUMP	To(85.0000, 250.0000, 110.0000, 0.0000), Height/Limit(20.0000, 200.0000), Vel/Jerk(100%, 100%), ArmOrientation(Right)
6		ARC	Via(-44.4458, 239.5284, 110.0000, 33.0800), To(-120.6913, 164.5902, 110.0000, 65.6601), Vel/Jerk(100%, 100%), ArmOrientation(Right)
7		JUMP	To(372.2250, -63.2786, 110.0000, -148.8402), Height/Limit(20.0000, 200.0000), Vel/Jerk(100%, 100%), ArmOrientation(Left)
8		CIRCLE	Via(351.7533, -113.7360, 110.0000, -160.2802), To(323.1731, -115.7006, 110.0000, -170.5002), Count(1), Vel/Jerk(100%, 100%), ArmOrientation(Left)

Figure 6.47 Example of the saved points

- From point A to point B (0->1): The trajectory is non-linear, and point B is a singular point. So MOVL or ARC mode cannot be used, but MOVJ mode is applicable. For details about singular point, please see *6.1.2 Alarms Description*.
- From point B to point C (1->2): The trajectory looks like a door. So JUMP mode is required. You need to set **Height** and **Limit** when saving point. The trajectory in JUMP mode depends on **Height** and **Limit**. For details, please see *2.3.4.2 Point to Point Mode (PTP)*.
- From point C to point D (2->3): The trajectory is a straight line. So MOVL mode is required. The arm orientations of point D and point C must be the same. Otherwise, an alarm will be generated.
- From point D to point E (3->4): The trajectory is a straight line. So MOVL mode is required. The arm orientations of point E and point D must be the same.
- From point E to point F (4->5): The trajectory looks like a door. So JUMP mode is required. You need to set Height and Limit.
- From point F to point H (5->6): The trajectory is an arc. So ARC mode is required. Besides point F and point G, you need to save point G. For details, please see *6.1.3 Saving Point in ARC Mode*. The arm orientation of point F must be the same as that of point G and point H.
- From point H to point I (6->7): The trajectory looks like a door. So JUMP mode is required. You need to set Height and Limit.
- From point I to point J (7->8): The trajectory is a circle. So CIRCLE mode is required. Besides point I and point J, you need to save point K. The method to save point in CIRCLE mode is the same as that of ARC mode. The arm orientation of point I must be the same as that of point J and point K.

6.10.2 Example of the External Drive

The current of the digital output supports 2mA without additional power, whereas the maximum current of the digital output supports 3A with additional power. Because the default drive capacity of Dobot M1 is insufficient. When the control device that is connected to the I/O interface need to provide a sufficient drive capacity, you must have an external drive to increase the drive capacity.

Figure 6.48 shows the connection between I/O interface and control device without additional power.

VCC_24V is the output voltage of the I/O interface of Dobot M1. OUT_x are the outputs of the I/O interface (assuming that OUT0 and OUT1). Please select the proper outputs based on site requirements. For details, please see 4.3 *Interface Description*.

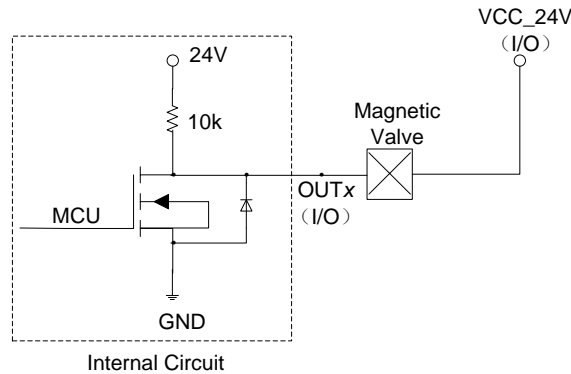

Figure 6.48 Connection between I/O interface and control device by default

Figure 6.49 shows the connection between I/O interface and control device with additional power. The red box in Figure 6.49 shows the external drive circuit. You can make an external drive circuit to meet the drive capacity requirements according to Figure 6.49.

- VCC_24V is the output voltage of the I/O interface of Dobot M1. OUT_x are the outputs of the I/O interface (assuming that OUT0 and OUT1). GND is the ground of the I/O interface. Please select the proper outputs based on site requirements. For details, please see 4.3 *Interface Description*.
- 24V is the external voltage. PGND is the ground corresponding to the external voltage.

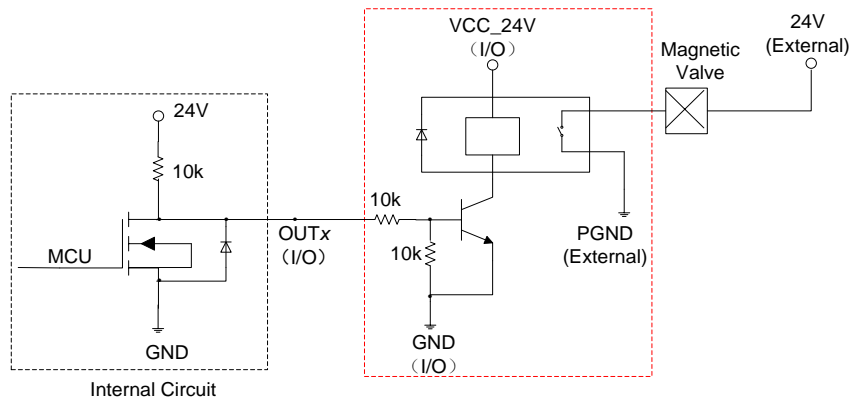

Figure 6.49 Connection between I/O interface and control device with external drive

6.10.3 Example of Switching the Arm Orientation at the Same Point

In MOVJ or JUMP mode, if the two points are the same, only different in arm orientations, J1 or J4 may be limited when Dobot M1 is moving, resulting in an alarm generated. You need to modify and resave the point for which the alarm is generated, and then clear the alarm manually.

The R-coordinate is the sum of the coordinates of J1, J2 and J4. The terminal posture relative

to the origin stays constant when moving Dobot M1. Table 6.12 lists how to calculate each Joint coordinate after switching the arm orientation at the same point.

Table 6.12 Joint coordinate calculation

Before	After
$R=J1+J2+J4$	$R'=R-J1'+J2'+J4'$
J1	$J1'=J1+J2$
J2	$J2'=-J2$
J3	$J3'=J3$
J4	$J4'=R-J1'-J2'$

As shown in Table 6.12, If the J1-coordinate is 10° and the J2-coordinate is 90° before switching the arm orientation, the J1-coordinate will change to 100° after switching, resulting in an alarm about limit generated. In real application scenario, if the two successive saved points are the same, only different in arm orientations, please notice the coordinates of J1 and J4. You can calculate J1-coordinate and J4-coordinate according to Table 6.12, in order to avoid generating an alarm about limitation.

6.10.4 Example of TCP/IP Control

TCP/IP control means that external equipment controls robot arm by sending commands with TCP/IP. External equipment is client, and main controller or M1Studio is server, as shown in Figure 6.50. Moreover, the IP address of the client and server must be in the same network segment.

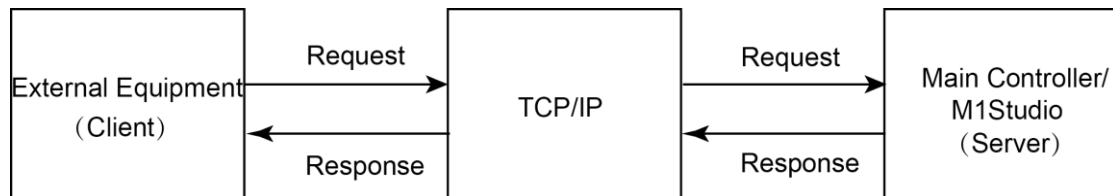

Figure 6.50 Communication process

This topic describes how to use external equipment to control robot arm by sending commands with TCP/IP.

Prerequisites

- Dobot M1 has been connected to a PC successfully. For details, please see 5.2.3 *Connecting Serial Port* or 5.2.4 *(Optional) Connecting Network Cable*.

If the server is the main controller, you must connect Dobot M1 and PC with network cable.

- Dobot M1 has been powered on.
- Dobot M1 has been connected to the emergency stop switch.

Procedure

Step 1 Configure server.

To build the remote control system, we need to create a server. We can take the PC where M1Studio is located or the main controller as a server. Program 6.1 shows the server script demo (supposing that the name is **syncServer.script**), and the parts of the demo shown in bold can be user-defined.

- If the server is the PC where M1Studio is located (Supposing that IP address is 192.168.1.10), Dobot M1 can be connected to PC by serial port or network cable, and **HOST, PORT = "192.168.1.10", 50030**.

The port cannot be occupied.

- If the server is the main controller (Suppose that IP address is 192.168.1.20), Dobot M1 can only be connected to PC by network cable, and **HOST, PORT = "192.168.1.20", 50030**.

The port cannot be occupied.

NOTICE

The IP address of server and client must be in the same network segment. Otherwise, the remote control is invalid.

Program 6.1 Sever script

```
import socket
import threading
import socketserver
import time
import math

class ThreadedTCPRequestHandler(socketserver.BaseRequestHandler):

    def setup(self):
        ip = self.client_address[0].strip()
        port = self.client_address[1]
        print(ip+": "+str(port)+" is connect!")

    def handle(self):
        while True: # add while for keep link
            data = self.request.recv(1024)
            if data:
                data = str(data, encoding = 'ascii')
                if data == 'exit':
```

```

        break;

    OperCMD(data)

    #cur_thread = threading.current_thread()

    #print what recieved
    response = bytes("{}".format(data), 'ascii')
    self.request.sendall(response)

def finish(self):
    print("client is disconnect!")
    print("stop")
    server.shutdown()
    exit(0)

class ThreadedTCPServer(socketserver.ThreadingMixIn, socketserver.TCPServer):
    pass

def OperCMD(strCMD):
    print(strCMD)

    #decode command type
    commandtype = strCMD[ : 3]
    print(commandtype)

    #get the value of command
    # index = strCMD.find(',')
    # tempStr1 = str[index+1 : ]

    #get X coord
    # index = tempStr1.find(',')
    # tempStr2 = tempStr1[:index]
    # PosX = tempStr2
    # print(PosX)
    # tempStr1 = tempStr2

    #get Y coord

    if (strCMD == "exit"):

```

```

print("stop")
server.shutdown()
exit(0)

elif (strCMD == "MoveP1" or strCMD == "p1"):      // Send Move P1 or P1 command, Dobot M1
                                                    will move as the following commands

    dType.SetArmOrientation(api, 1, 1)
    dType.SetPTPCmd(api, 0, 229, 212, 120, 0, 1)
    dType.SetARCCmd(api, [62,265,120,50], [-58,266,120,76], 1)

elif (strCMD == "MoveP2" or strCMD == "p2"):      //Send Move P2 or P2 command, Dobot M1
                                                    will move as the following commands

    dType.SetArmOrientation(api, 1, 1)
    dType.SetPTPCmd(api, 0, 229, 212, 120, 0, 1)
    dType.SetARCCmd(api, [62,265,120,50], [-58,266,120,76], 1)

HOST, PORT = "192.168.1.10", 50030                // IP address and Port of the server
socketserver.TCPServer.allow_reuse_address = True
server = ThreadedTCPServer((HOST, PORT), ThreadedTCPRequestHandler)
ip, port = server.server_address
server_thread = threading.Thread(target=server.serve_forever)
server_thread.daemon = True
server_thread.start()
server.serve_forever()

```

Step 2 Import Script.

NOTE

The way to import script depends on the server, please select based on site requirements.

- If the server is PC where M1Studio is located, please execute the following steps.
 1. Select the corresponding serial port or IP address from the serial drop-down list on the upper left pane of the M1Studio page and click **Connect**.
 2. Import the script on the **Script** of M1Studio page and click **Start**.
- If the server is the main controller, please execute the following steps.
 1. Select the corresponding IP address from the serial drop-down list on the upper left pane of the M1Studio page and click **Connect**.
 2. Click **Tools > Web Management > Upload Offline Script** to upload the script to the main controller, as shown in Figure 6.51.

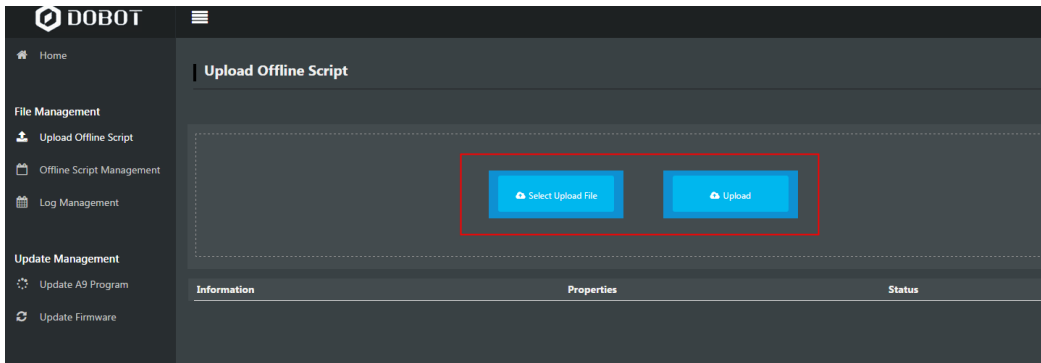

Figure 6.51 Upload script

3. Select the uploaded script (syncServer.script) on the **Offline Script Management** page and click **Offline** to make the script in the offline status, as shown in Figure 6.52.

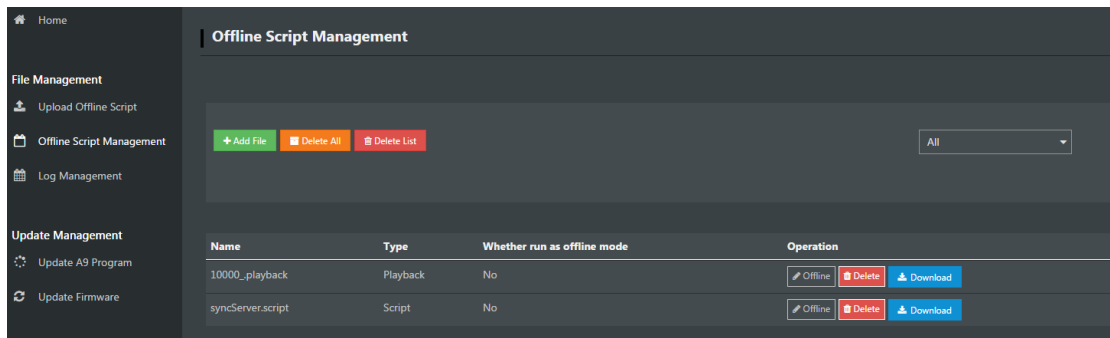

Figure 6.52 Script status

4. Select **Offline Mode** from the drop-down list on the **Mode Switch Controlling** pane of the **Home** page, and click **Start** to make Dobot M1 in the **Offline Mode** status, as shown in Figure 6.53.

Now, the blue LED indicator on the base of Dobot M1 is blinking.

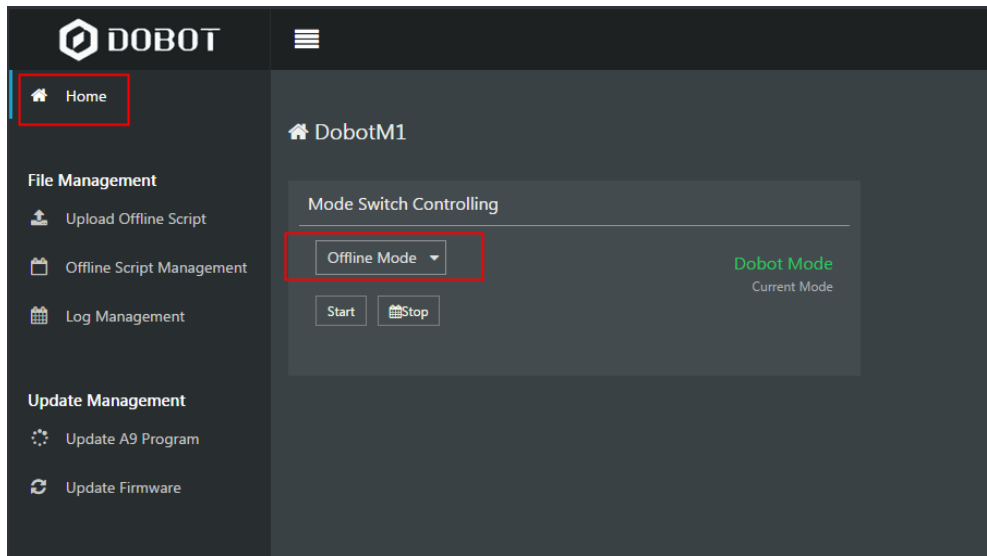

Figure 6.53 Mode switch

Step 3 Configure client.

Input the IP address and port of the server on the client and click **Connect**, as shown in Figure 6.54.

NOTE

The external equipment used for controlling robot arm depends on the actual applications. In this topic, we take debugging assistant as an example to describe how to configure client, please replace it based on site requirements.

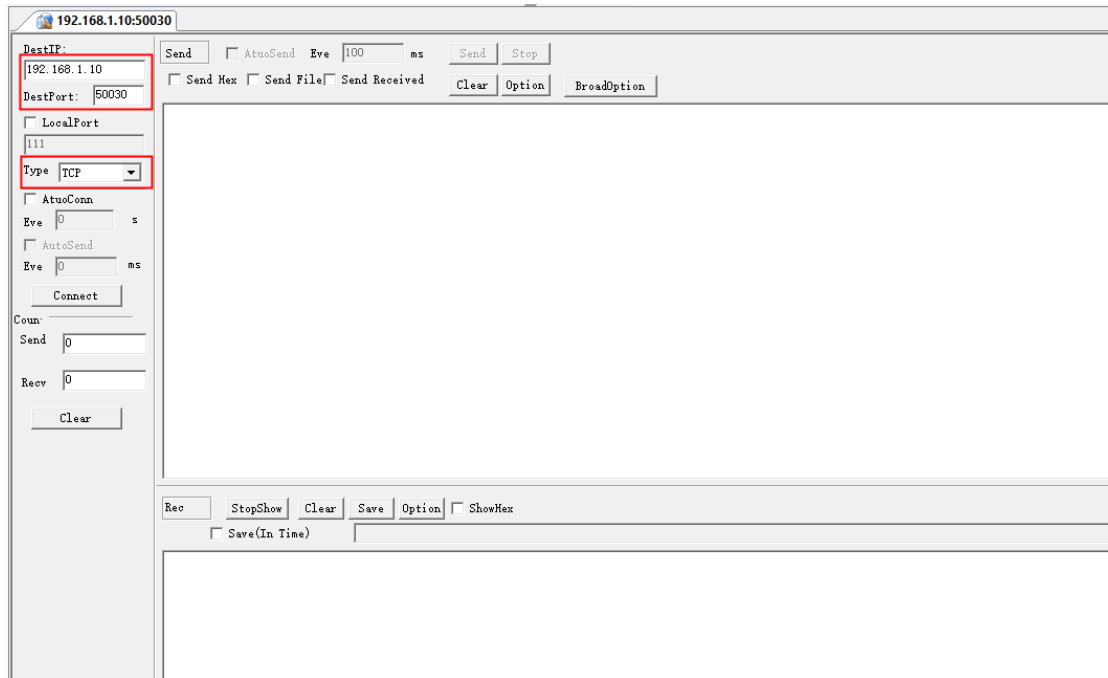

Figure 6.54 Configure client

Step 4 Send **MoveP1** command in the sending section of client, as shown in Figure 6.55.

Now, Dobot M1 will move as the motion commands in the script.

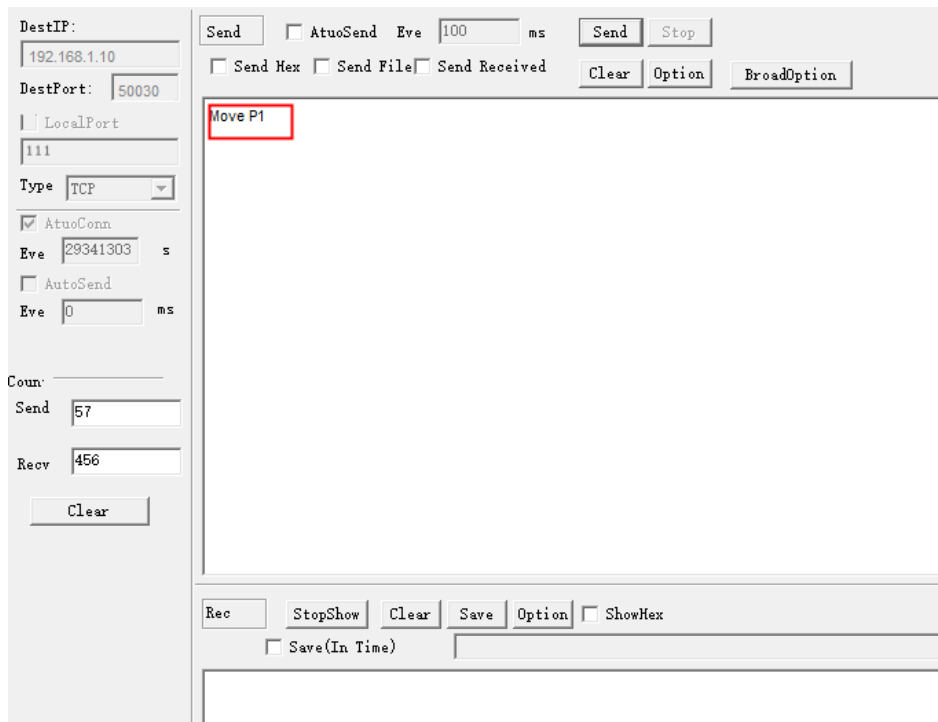

Figure 6.55 Send commands on the client

6.10.5 Example of External Expansion I/O Control

External I/O control means that external equipment controls robot arm by external expansion I/O. In this topic, we take PLC as the external equipment to describe how to use PLC to control robot arm by external expansion I/O. Besides robot arm and PLC, we need to prepare DB62 expansion suite (include DB62 cables and expansion board, and purchase separately). Figure 6.56 shows the DB62 expansion suite.

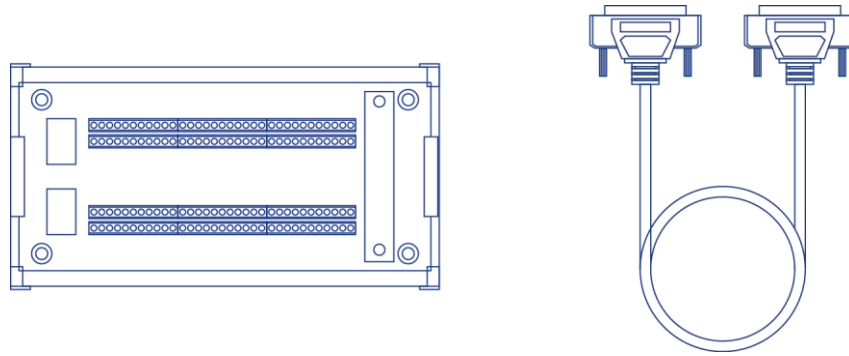

Figure 6.56 DB62 expansion board

For details about external expansion I/O interface description, please see *4.3.3 External Expansion Interface*.

Prerequisites

- You have launched M1Studio.
- You have connected Dobot M1 to a PC over network cable or router, and the IP address of Dobot M1 and the PC must be in the same network segment. For details, please see *5.2.4(Optional) Connecting Network Cable*.

In this topic, we use a router to connect Dobot M1 and PC.

- You have powered on Dobot M1.
- You have obtained the scripts, the blockly programs, or the saved points lists which are run normally. In this topic, we take script as an example.
- Dobot M1 has been connected to an emergency stop switch.
- You have installed the PLC programming software.

In this topic, we use the FX5U PLC and GX Works3 programming software. For details on how to use are not described in this topic.

Figure 6.57 shows the connections demo.

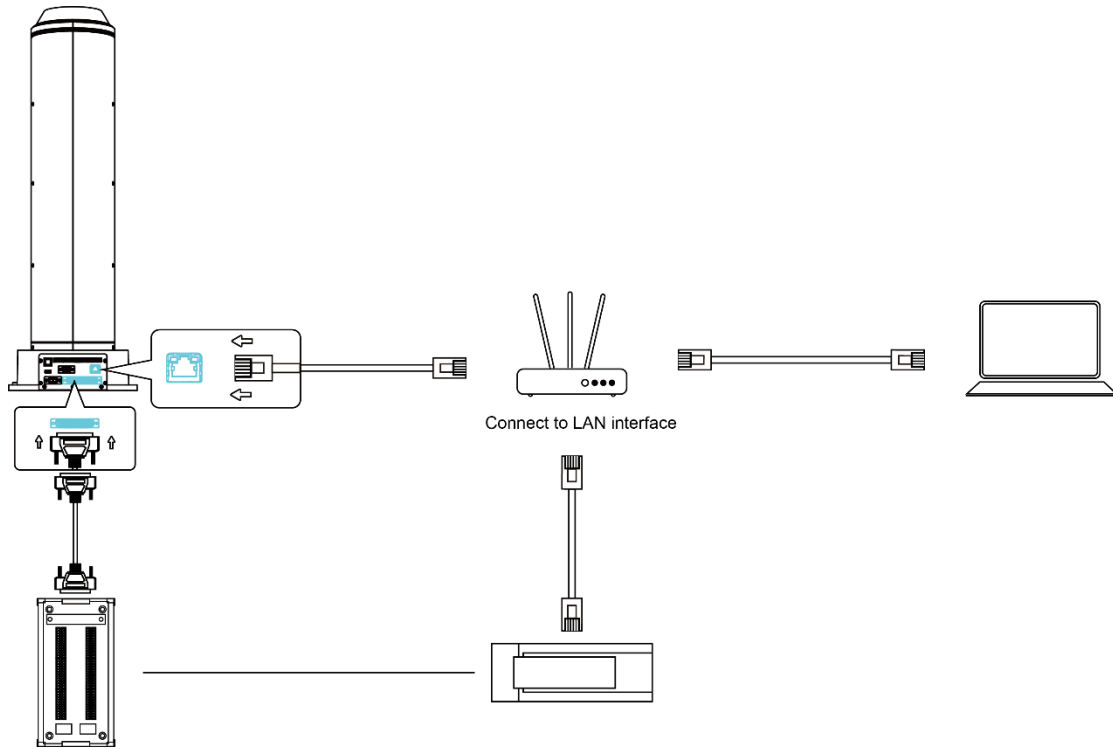

Figure 6.57 Connection Demo

Procedure

Step 1 Connect one end of the DB62 cable to the external expansion I/O interface on the base of Dobot M1 and the other end to the expansion board, as shown in Figure 6.58.

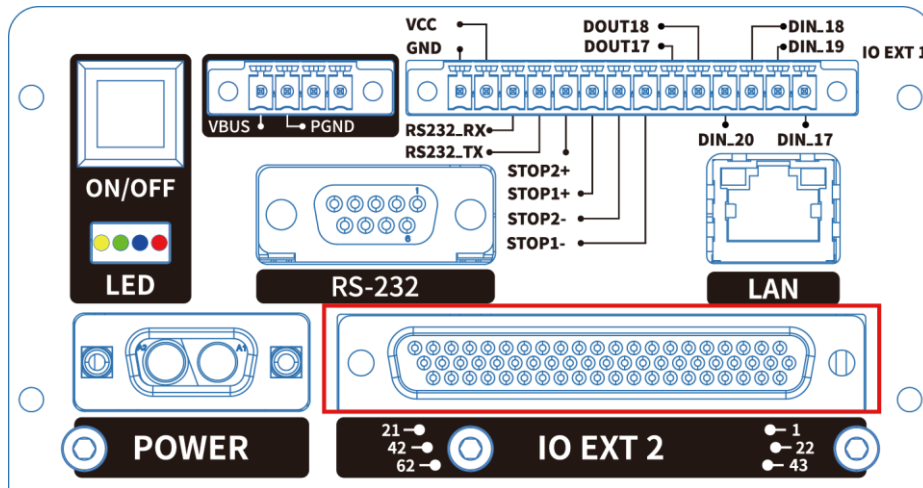

Figure 6.58 Connect to external expansion I/O interface

Step 2 Connect PLC and PC. In this demo, we use a router to connect PLC and PC, please replace it based on site requirements.

Step 3 Connect the expansion board to the PLC. Supposing that we use PLC interfaces from Y0 to Y5, as shown in Figure 6.59.

Please use the wires of which the size is from 20 AWG to 24 AWG for connections.

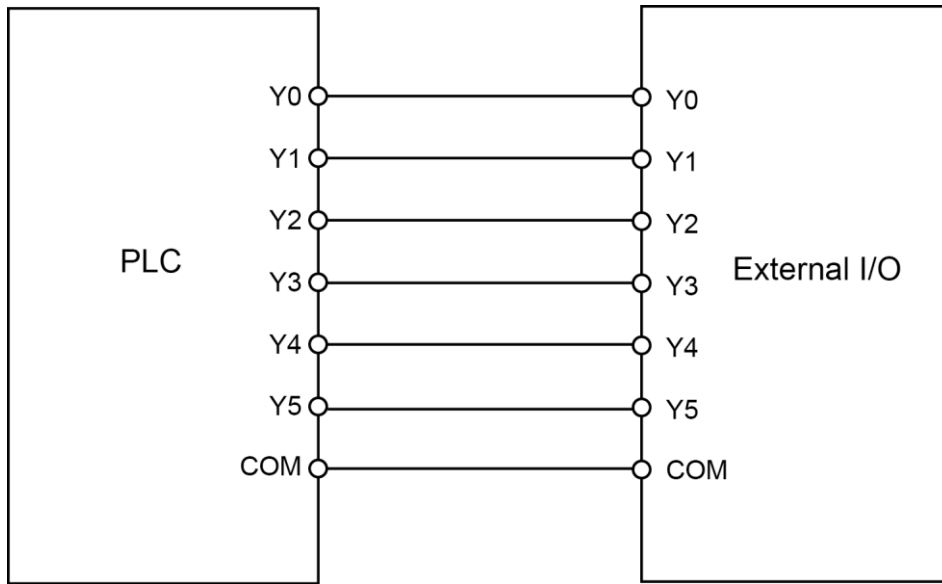

Figure 6.59 Connection between PLC and expansion board

Table 6.13 lists the definitions of external expansion I/O interfaces from DIN10 to DIN15.

Table 6.13 DIN10 - DIN 15 interfaces definition

Interface	Description
DIN10	Reset signal
DIN11	External I/O control signal. Namely, Dobot M1 activates external I/O control function
DIN12	Continue signal
DIN13	Pause signal
DIN14	Stop signal After this signal is triggered, Dobot M1 will stop offline running while the external I/O control will remain in force. At this point, you can use M1Studio to control Dobot M1 in Dobot mode or trigger DIN 15 to make Dobot M1 run in offline mode again
DIN15	Start signal, for running in offline mode Before triggering this signal, please trigger DIN 11 first

NOTE

All signals Table 6.13 are falling edge triggered.

Step 4 Upload the obtained scripts to the main controller.

1. Select the corresponding IP address from the serial drop-down list on the upper left pane of the M1Studio page and click **Connect**.
2. Click **Tools > Web Management > Upload Offline Script** to upload the script to the main controller, as shown in Figure 6.60.

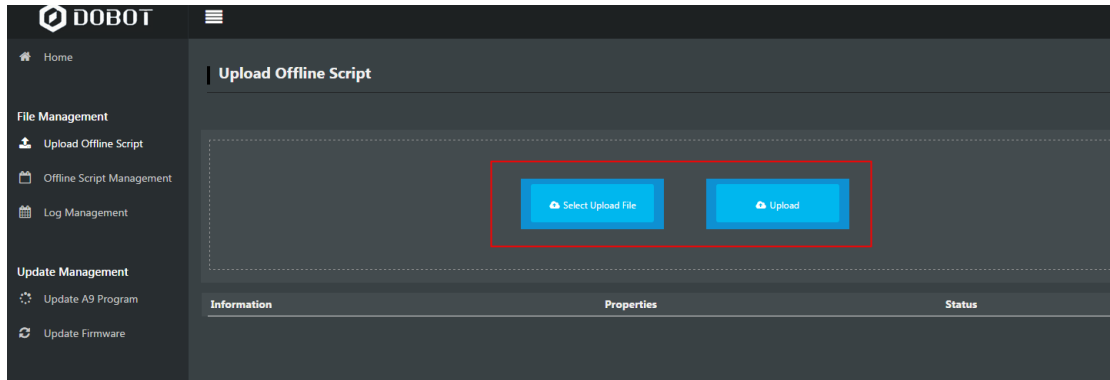

Figure 6.60 Upload script

3. Select the uploaded script on the **Offline Script Management** page and click **Offline** to make the script in the offline status, as shown in Figure 6.61.

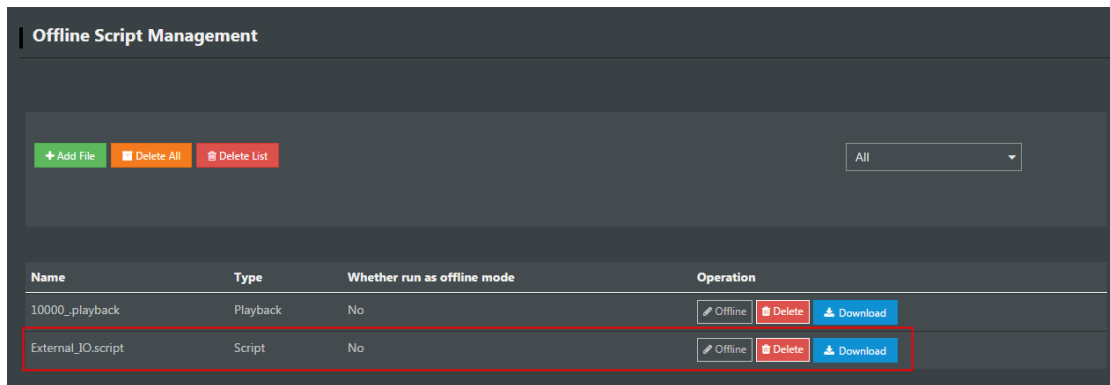

Figure 6.61 Script status

Step 5 Create a new PLC project and build it on the GX Works3 programming software, as shown in Figure 6.62.

How to build PLC project is not described in this topic.

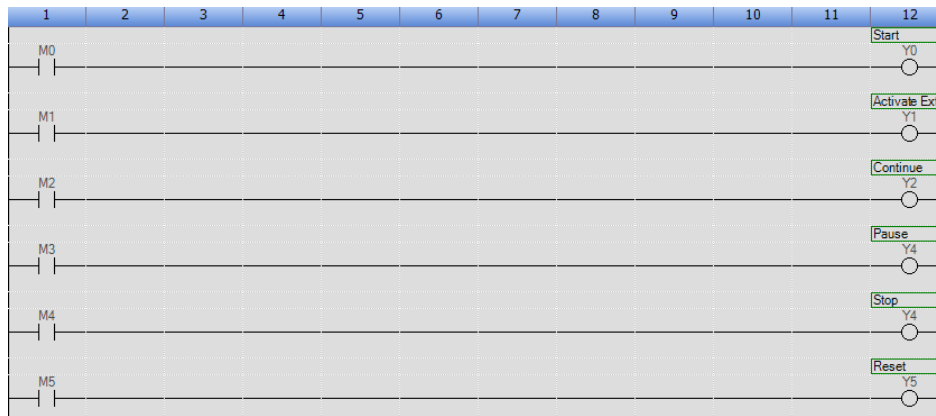

Figure 6.62 PLC program

Step 6 Check the connections between PLC and expansion board.

1. Select the corresponding IP address from the serial drop-down list on the upper left pane of the M1Studio page and click **Connect**.

2. Select **Tools > I/O Assistant**.

The **I/O Assistant** page is displayed.

3. Trigger **Y0** on the GX Works3 page, and observe the changes of **DIN 10** on the **I/O Assistant** page.

If the voltage of DIN 10 shown on the **I/O Assistant** page is changed, it indicates that the connection is correct. Otherwise, please reconnect it.

4. Check **DIN 11 - DIN 15** according to **3** and Figure 6.59.

It is recommended that **DIN 11** is checked at last, since DIN 11 is triggered, Dobot M1 activates the external I/O control function, and then when DIN 15 is triggered, Dobot M1 will run in offline mode.

Step 7 Control Dobot M1 in offline mode by external I/O.

1. Trigger **Y1** on the GX Works3 page, Dobot M1 will activate the external I/O control function.

2. Trigger **Y5** and Dobot M1 will run in offline mode.

If stopping Dobot M1 running in offline mode is required, please trigger **Y4**. At this point, Dobot M1 stops offline running, while the external I/O control remains in force. If continuing Dobot M1 running in offline mode is required, please trigger **Y5** directly.

7. Maintenance

7.1 Routine Maintenance

7.1.1 Routine Inspection

Due to the temperature, humidity, dust and vibration, the components will be aged, leading to reducing product service life. Performing maintenance inspections and procedures properly is essential for preventing trouble and ensuring safety. Especially in high temperature environment, frequently start-stop scenario, and other special scenarios, you need to shorten the inspection period.

To ensure product function and safety, please check the following items daily.

Item	Operating state	Inspection point	Solution
External cable	OFF	<ul style="list-style-type: none"> • Check whether cables are damaged or cracked • check whether cables are loose, dirty or polled out 	<ul style="list-style-type: none"> • If the cables are damaged or cracked, please repair or replace them timely • If the cables are loose or polled out, please plug them properly • If the cables are dirty, please clean them timely
Bolt, screw	OFF	<ul style="list-style-type: none"> • Check whether the bolts on the end effector are loose • Check whether the bolts on the base are loose 	If the bolts are loose, please tighten them
Cover	OFF	Please check the covers of robotic arm are flawed	If that happens, please replace them timely
Startup	ON	Check whether robotic arm is shaken	<ul style="list-style-type: none"> • If the connections are abnormal, please reconnect them • If the screws are loose, please tighten them
Emergency stop switch, LED indicators and	ON	Check whether the LED indicators are displayed	If that happens, please replace the corresponding

Item	Operating state	Inspection point	Solution
buttons		normally and emergency stop switch is working regularly	components timely

7.1.2 Periodic Inspection

In order to keep the good operation of robotic arm, please check the place where it is hard to check regularly. The inspection period depends on the operating environment and frequency, please decide the inspection period based on site requirements. Please remove surface dust effectively to prevent dust (especially metal dusts) from entering the product, ensuring that robotic arm is always clean.

Item	Operating state	Inspection point	Inspection period	Solution
Internal fan of robotic arm	ON	<ul style="list-style-type: none"> Check whether the fan is running properly Check whether the fan is dusty 	3 months	<ul style="list-style-type: none"> If the fan is out of service, please replace it If the fan is dirty, please use compressed air to clean surface dust
Mechanical limitation of J1, J2, J3	OFF	Check whether joints are cracked	6 months	If that happens, please replace it timely
Synchronizing wheel of R-axis	OFF	Check whether the synchronizing wheel is loose	6 months	If that happens, please re-tension it

Item	Operating state	Inspection point	Inspection period	Solution
Bolt, screw	OFF	<ul style="list-style-type: none"> Check whether the screws and bolts around each joint of robotic arm are loose Check whether the screws and bolts of motor and reducer are loose 	12 months	If that happens, please tighten them
Enabling Robotic arm	ON	Check whether each arm can be moved by hand in the open-loop state	12 months	If that happens, please contact technical support engineer

7.1.3 Cleaning Maintenance

The cleaning period depends on the operating environment and frequency, please decide the cleaning period based on site requirements.

Item	Operating state	Cleaning period	Solution
Robotic arm	OFF	1 month	Please clean the surface with clean cloth
Wind tunnel	OFF	2 weeks	Please clean the impurities stored in the wind tunnel with air gun or clean cloth
Screw rod of Z-axis	OFF	12 months	Please add lubricating oil or grease. For details, please see <i>7.2.1 Greasing Screw Rod of Z-axis</i>
Guide rail of Z-axis	OFF	2 weeks	Please add lubricating oil or grease. For details, please see <i>7.2.2 Greasing Guide Rail of Z-axis</i>

Common disinfectant, cleaning liquid can be used for cleaning robotic arm. Please do not use

acidic cleaning fluid for routine maintenance.

7.2 Maintenance of Mechanical Parts

7.2.1 Greasing Screw Rod of Z-axis

If the grease on the screw rod has been used up, the screw rod may be worn down and make a noise. You need to check the grease every other year. If the grease is applied too much or uneven, the load of motor may be increased and the grease may be dripped from the screw rod. You can check whether the grease is used up by wiping the surface of the screw rod with air-laid paper. If there is no grease on the air-laid paper, the grease is used up.

Procedure

- Step 1** Please power off Dobot M1 and remove the Z-axis cover with 2.5# hexagon wrench.
- Step 2** Restart Dobot M1.
- Step 3** Select the corresponding serial port from the serial drop-down list, and click **Connect**.

If **Connect** turns to **Disconnect**, the connection is successful, and Dobot M1 can be controlled by M1Studio.

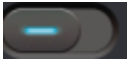
- Step 4** Click the  icon of **Motor** on the **Operation Panel** pane of the M1Studio page to make Dobot M1 in the open-loop state
- Step 5** Move Dobot M1 to the bottom of Z-axis by hand.
- Step 6** Apply moderate amount of grease on the screw rod. The type of grease is 3# Lithium Grease.

Please apply the grease evenly with specialized oil brush. Figure 7.1 shows the screw rod of Z-axis.

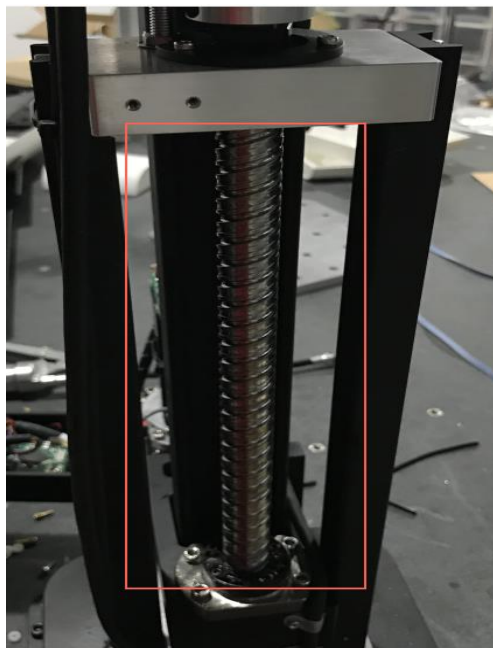

Figure 7.1 Screw rod of Z-axis

- Step 7** Move Dobot M1 to the top of Z-axis by hand.
- Step 8** Apply a small quantity of grease evenly on the bottom of the screw rod.
- Step 9** Move up and down the Z-axis to the limitation repeatedly (3-5 times) to scrap the grease stored on each end.
- Step 10** Power off Dobot M1 and install the Z-axis cover with 2.5# hexagon wrench.
It can be put into use after installation.

7.2.2 Greasing Guide Rail of Z-axis

If the guide rail is used without grease, the guide rail will be worn down and the service life will be reduced. You need to grease the guide rail every two weeks for long service.

Prerequisites

Please prepare the correct-size syringe (a diameter of no more than 2cm) and needle to ensure that the syringe can touch the guide rail of Z-axis.

Procedure

- Step 1** Move Dobot M1 to the bottom of Z-axis and power off Dobot M1.
- Step 2** Stretch the syringe with needle into the guide rail from the gap in the top of the shell of Z-axis, as shown in Figure 7.2. Inject two or three drops of grease on each side of guide rail respectively. The grease of which the kinematic viscosity is 30cst to 150cst is recommended, such as engine oil.

After 15 minutes, restart Dobot M1 to put it into use.

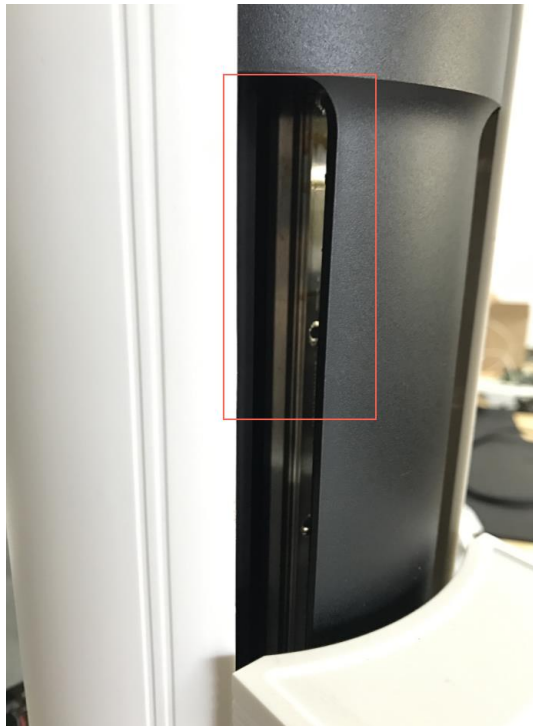

Figure 7.2 Guide rail of Z-axis

7.3 Maintenance of Electrical Parts

 NOTICE

Please notice the anti-static precautions during electrical operation, such as wearing anti-static wrist strap to ensure that the internal parts of robotic arm are not damaged.

7.3.1 Encoder Battery Maintenance

When the battery voltage is less than 3V, the homing point may be error, and the alarm about low battery voltage is generated. There are two ways to maintain Encoder battery.

- Execute homing procedure to reset Encoder automatically and recover the homing point. For details, please see *7.3.1.1 Operating Homing Procedure*.
- Replace the battery. For details, please see *7.3.1.2 Replacing Encoder Battery*.

7.3.1.1 Operating Homing Procedure

Procedure

- Step 1** The page shown in Figure 7.3 is displayed when the low battery voltage alarm is triggered.

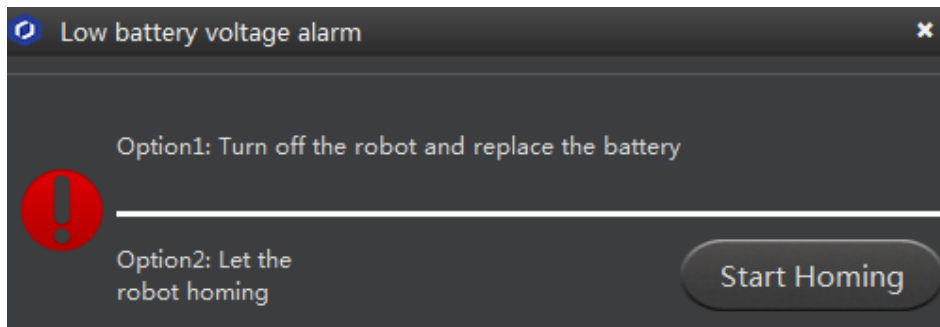

Figure 7.3 Low battery voltage alarm

- Step 2** Click **Start Homing** on the **Low battery voltage alarm** page.
- Step 3** Select the tip shown in the page and click **Homing**, as shown in Figure 7.4.

NOTE

This step is to make sure that there are no obstacles within the workspace, to avoid homing failure because of collision.

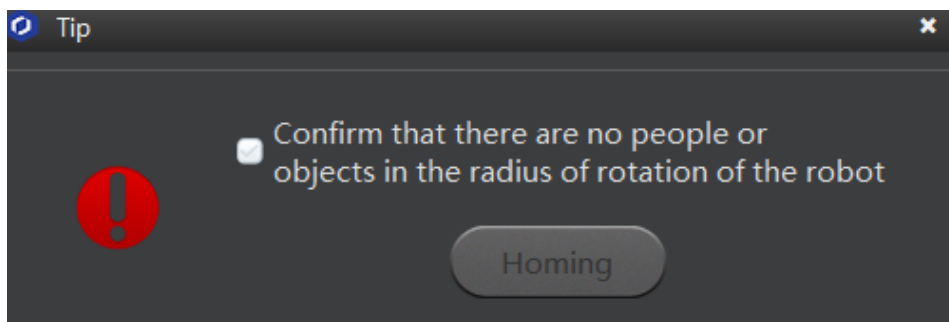

Figure 7.4 Homing procedure

Dobot M1 will move automatically according to the following steps.

1. J3 moves to the upper limit with a signal triggered by the homing switch, and moves backward at low speed to separate from the homing switch, and then stops moving.
2. J1 and J2 move to the limit as lefty hand orientation with signals triggered by homing switches of J1 and J2, and move backward at low speed to separate from the homing switches, and then stop moving, indicating that Dobot M1 has moved to the homing point.

After the homing procedure is completed, the coordinate of the homing point is shown as Figure 7.5. If the coordinate you get is quite different from Figure 7.5, it indicates that the homing procedure is failed, please re-execute again.

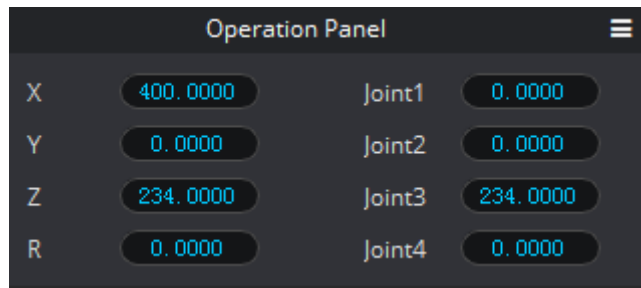

Figure 7.5 Homing point

7.3.1.2 Replacing Encoder Battery

The battery is located on the main controller of the base or Forearm. The position of the battery depends on the production batch of Dobot M1.

Warning

- If a fuse is not installed on the battery, please contact technical support engineer. We will provide the replacing solution of the Encoder battery with a fuse.
- If a fuse is not installed on the battery, in some cases, for example, disassembling machine without professional may cause wire breakage and battery charging, leading to equipment damage or even battery explosion.

Table 7.1 Replacement parts list

Type	Name	Quality	Remark
Maintenance parts	Battery with welding cable LS 14250	1	-
	Wire tie	1	Please prepare by yourself

Type	Name	Quantity	Remark
Tools	Hexagonal wrench (2.5mm)	1	-
	Cross head screw- driver	1	Please prepare by yourself
	Nippers	1	Please prepare by yourself
	Insulating tape	1	Please prepare by yourself

 NOTICE

After replacing the battery, please do not dispose elsewhere. All discarded batteries must be uniformly reclaimed to avoid environmental contamination.

Procedure

- Step 1** Hold down the power button in the base of Dobot M1 for about 5 seconds, and then release your fingers to power off Dobot M1. Pull out the power plug from the power source to shut off power to the robot system.
- Step 2** Detach all cables from the interface board of the base.
- Step 3** Check the location of the battery and remove it.
- If the battery is located on the base, please perform the following steps.
 1. Loosen the four screws on the interface board of the base using 2.5# hexagonal wrench, as shown in Figure 7.6.



Figure 7.6 Interface board of the base

NOTE

The appearance of the interface board depends on the production batch of Dobot M1. However, the replacement method remains unchanged.

2. Move out the main controller from the base.

Please move out the main controller lightly to prevent disconnection between the main controller and the robotic arm.

3. Remove the original battery.

NOTE

After removing the battery from the main controller on the base, you need to install the battery to be replaced on Forearm instead of the base. For details, please see **Step 4** to **Step 9**.

- If a fuse is installed on the battery, please cut off the wire tie that fixed the original battery, as shown in Figure 7.7. Remove the battery from the battery holder and disconnect the connector of the original battery to the battery adapter cable, as shown in Figure 7.8.

After removing the original battery, please wrap the connector of the battery adapter with insulating tape to prevent short circuit.

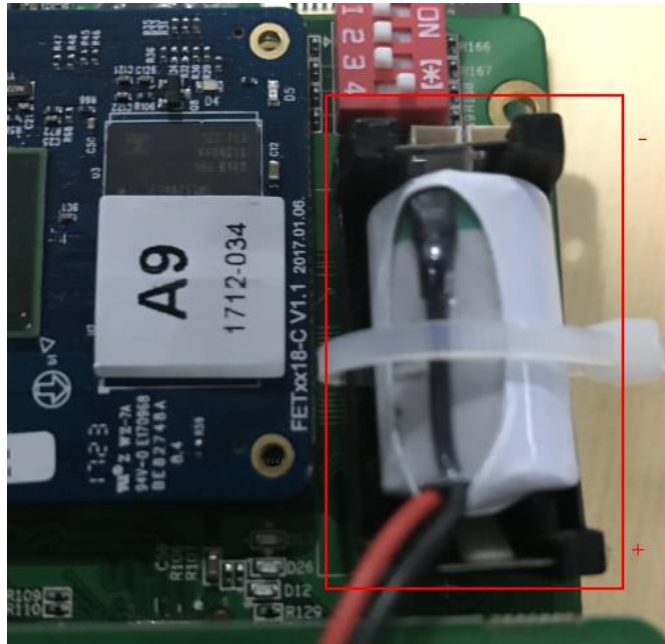

Figure 7.7 Location of battery holder



Figure 7.8 Disconnect the connector of the battery to the battery adaptor cable

- If a fuse is not installed on the battery, please remove the cover of battery holder to take out the original battery and detach the battery connector of bus cable connecting to the battery holder, as shown in Figure 7.9.

After removing the original battery, please wrap the battery connector of the bus cable with insulating tape to prevent short circuit.

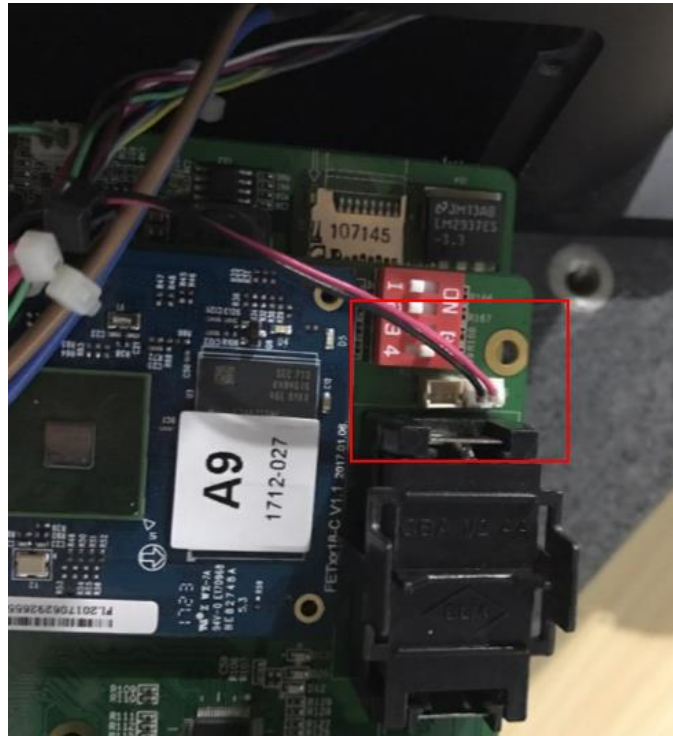

Figure 7.9 Connection between battery and robotic arm

4. Put the main controller into the base, and fix the interface board.
- If the battery is located on Forearm, please perform the following steps.
 1. Remove the Forearm cover with 2.5mm hexagon wrench and cross head screw-driver, as shown in Figure 7.10.



Figure 7.10 Forearm of Dobot M1

2. Cut off the wire tie that fixed the original battery, as shown in Figure 7.11.

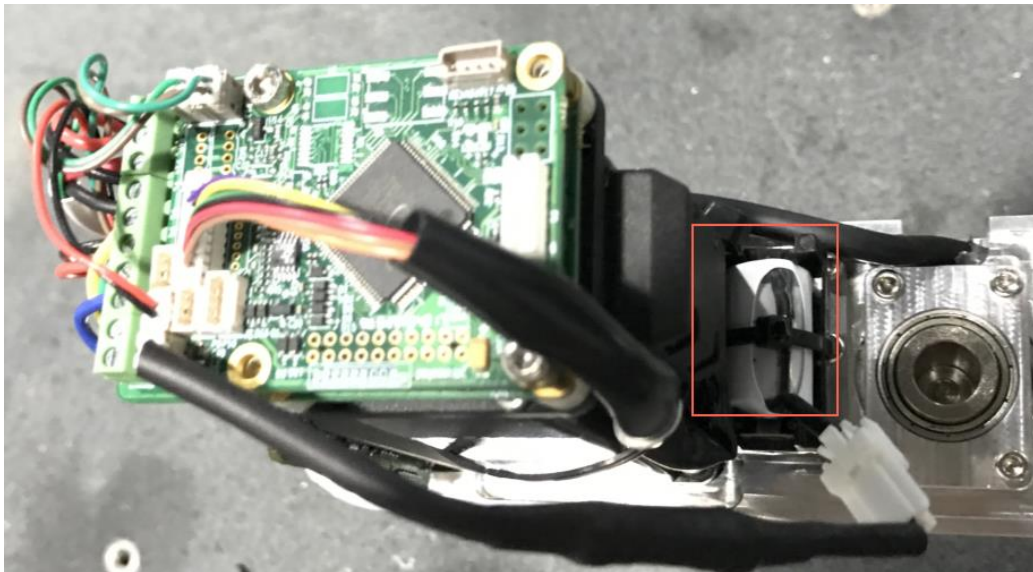

Figure 7.11 Location of battery holder on Forearm

3. Remove the original battery and disconnect the connector of the battery to the battery adapter cable, as shown in Figure 7.12.

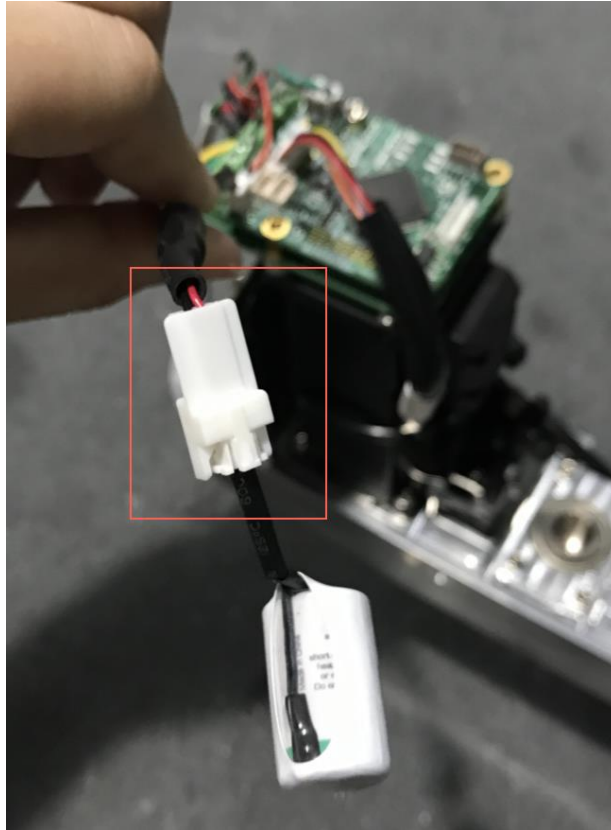

Figure 7.12 Disconnect the battery to the batter adapter

- Step 4** Remove the Forearm cover with 2.5mm hexagon wrench and cross head screwdriver. If it has been removed, please skip this step.
- Step 5** Connect one end of the battery adapter cable to the battery interface on the Driver Board, as shown in Figure 7.13. If it has been connected, please skip this step.

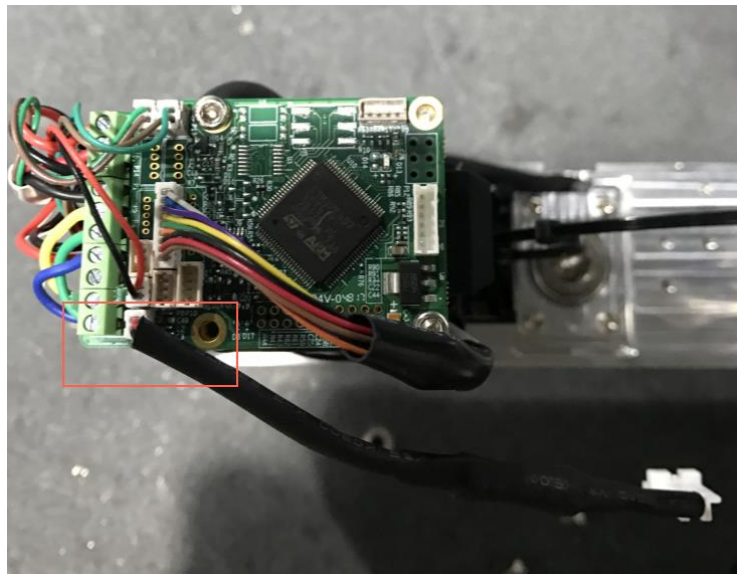

Figure 7.13 Connect the battery adapt to the battery interface

NOTE

There are two battery interfaces on the Driver Board, as shown in the red box of Figure 7.14. You need to connect the battery adapter to the unused battery interface.



Figure 7.14 Battery interfaces on the Driver Board

- Step 6** Connect the connector of the standby battery to the other end of the battery adapter cable, as shown in Figure 7.15.

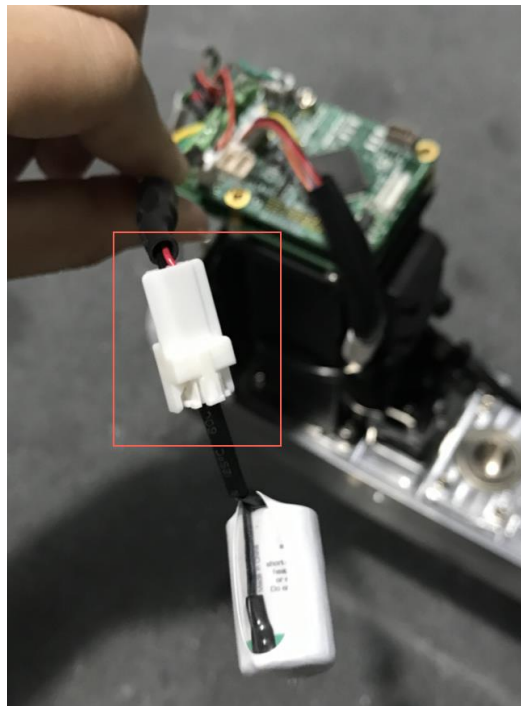

Figure 7.15 Connect the battery to the batter adapter

- Step 7** Insert the wire tie to the battery holder on Forearm to fix battery, as shown in Figure 7.16.

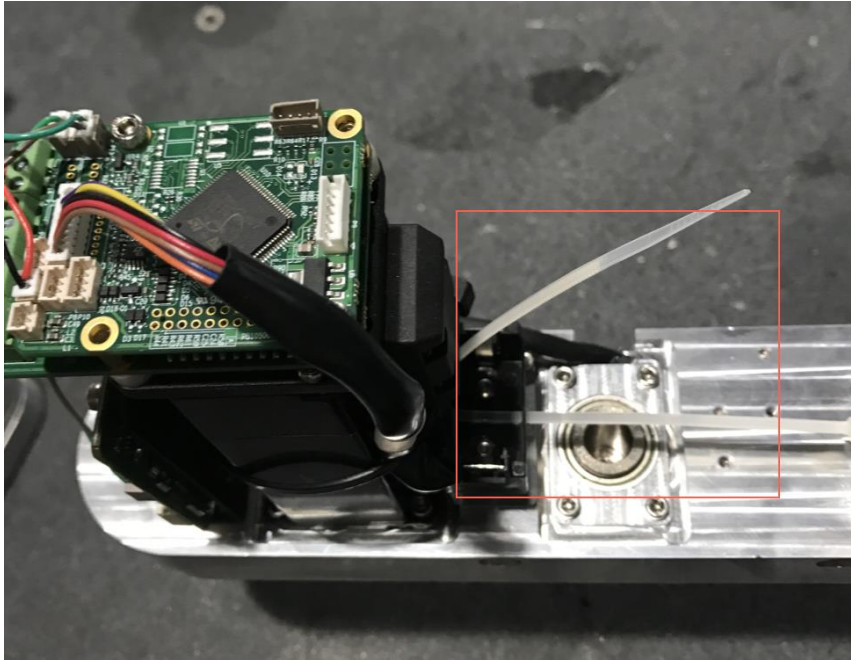

Figure 7.16 Insert wire tie

- Step 8** Put the standby battery into the battery holder as shown in Figure 7.17 and cut off the redundant wire tie.

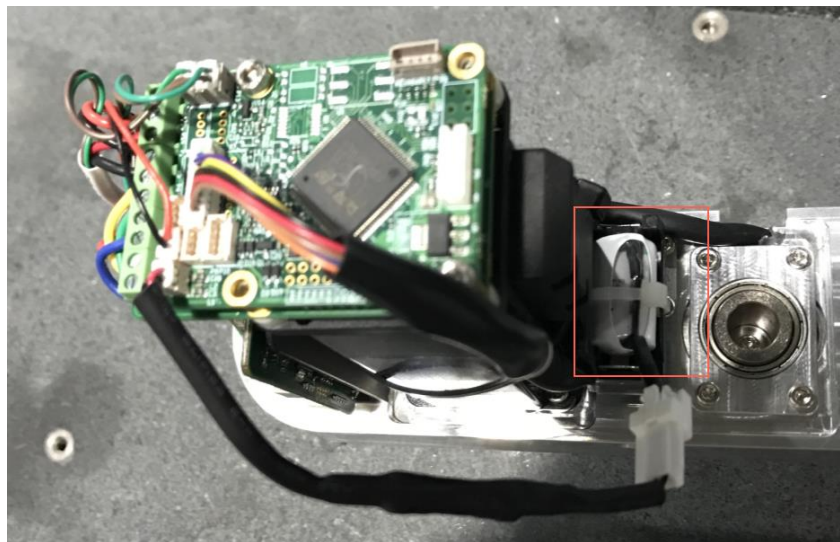

Figure 7.17 Put battery into battery holder

- Step 9** Re-fix the Forearm cover.
- Step 10** Reconnect the external equipment required to Dobot M1, and restart Dobot M1.
- Step 11** Reset Encoder.

After replacing the battery, the position data on the Encoder will be lost. It is necessary to reset Rear Arm Encoder, Forearm Encoder, Z-axis Encoder and R-axis Encoder respectively.

1. Click **Initialization.exe** in the *installing directory*/M1Studio/tools/Initialization directory.

The M1Studio tool page is displayed.

2. Select the corresponding serial port from the serial drop-down list, and click **Connect**.

If **Connect** turns to **Disconnect**, the connection is successful, and Dobot M1 can be controlled by M1Studio.

3. Click **Reset Encoder1**, **Reset Encoder2**, **Reset Encoder3**, and **Reset Encoder4** respectively on the **Debug** page to reset J1 Encoder, J2 Encoder, J3 Encoder and J4 Encoder, as shown in Figure 7.18.

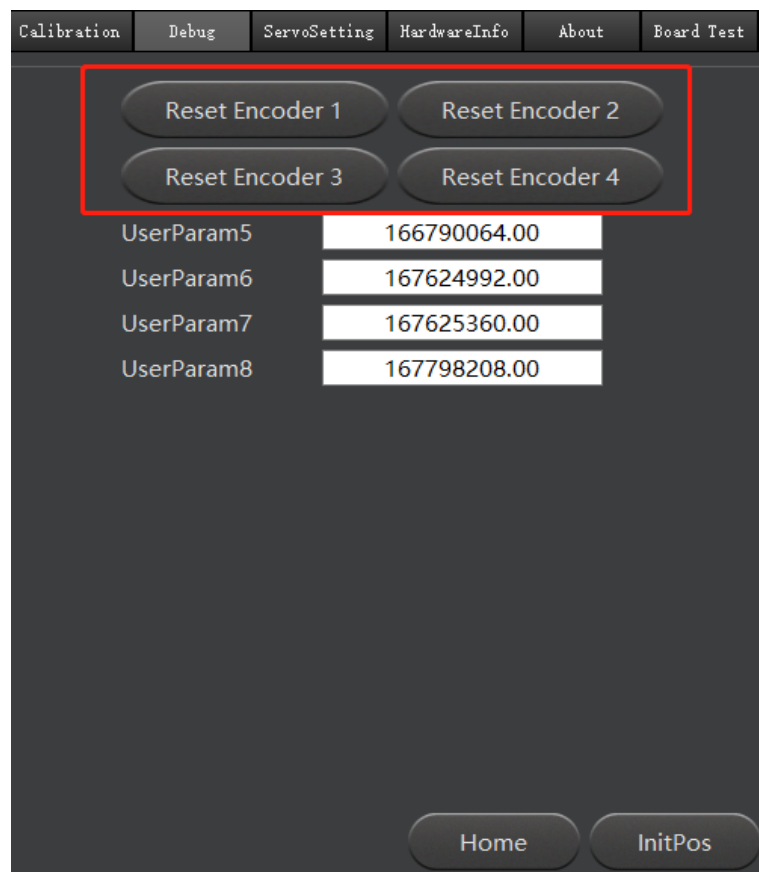

Figure 7.18 Reset Encoders

4. Restart Dobot M1.
5. Check whether encoders are reset on the **Debug** page. Please check the default values of the encoders (**UserParam5** to **UserParam8**). If the values range from **163790000** to **196548000**, the operation is successfully.
6. Select the corresponding serial port from the serial drop-down list, and click **Connect**.

If **Connect** turns to **Disconnect**, the connection is successful, and Dobot M1 can be controlled by M1Studio.



7. Click the  icon of **Motor** on the **Calibration** page to make the motor of Dobot M1 in the open-loop state.
8. Jog Dobot M1 by hand to make Rear Arm and Forearm in a straight line and perpendicular to the base forward, and then jog Dobot M1 to the bottom of Z-axis, as shown in Figure 7.19.



Figure 7.19 Location of Dobot M1 after Factory calibration

9. Click the  icon of **Motor** on the **Calibration** page to make the motor of Dobot M1 in the close-loop state.
10. Click **InitPos** on the **Debug** page to make Dobot M1 in the origin position of which the coordinate is (400,0,0,0).

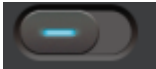
NOTICE

After restoring factory setting, an alarm about limitation is generated and meanwhile the red indicator on the base of robotic arm is on, which is a normal phenomenon. At that point, you need to click **J3+** under Joint coordinate system to jog robotic arm to the position where the J3 value is above 10mm, and then the alarm will be cleared.

Step 12 After resetting Encoder, you need to calibrate J2. For details, please see *7.3.2 Calibration*.

7.3.2 Calibration

In real applications, the high absolute precision of robotic arm is required. The origin

(400,0,0,0) has been set by default, Dobot M1 can be directly put in use. After parts (motors, reduction gear units, battery, etc.) have been replaced or robotic arm has hit the work piece, the origin of Dobot M1 will be changed. You need to reset the origin. When Dobot M1 moves with different arm orientation, the high precision of J2 is required. Therefore, after resetting the origin, you need to calibrate J2 to improve the absolute precision.

Generally, before and after switching the arm orientation at the same point, the J2 coordinates are axisymmetric. After resetting the origin, the J2 coordinates may become non-axisymmetric, resulting in that Dobot M1 cannot move to the same point with different arm orientation when implementing playback. It is necessary to make the J2 coordinates axisymmetric by compensating the joint angel of J2 to improve the absolute precision after resetting the origin. So that Dobot M1 can move to the same point with different arm orientation when implementing playback.

Prerequisites

- Dobot M1 has been powered on.
- Dobot M1 has been connected to the PC successfully.
- Dobot M1 has been connected to the emergency stop switch.
- The pen holder kit has been installed on the terminal. The size of the pen holder should be according with the size of the terminal. For details, please see 3.3 (*Optional*) *Installing End Effector*.
- Please prepare an A4 sheet of paper, and draw a small dot as a calibrated point, as shown in Figure 7.20 .

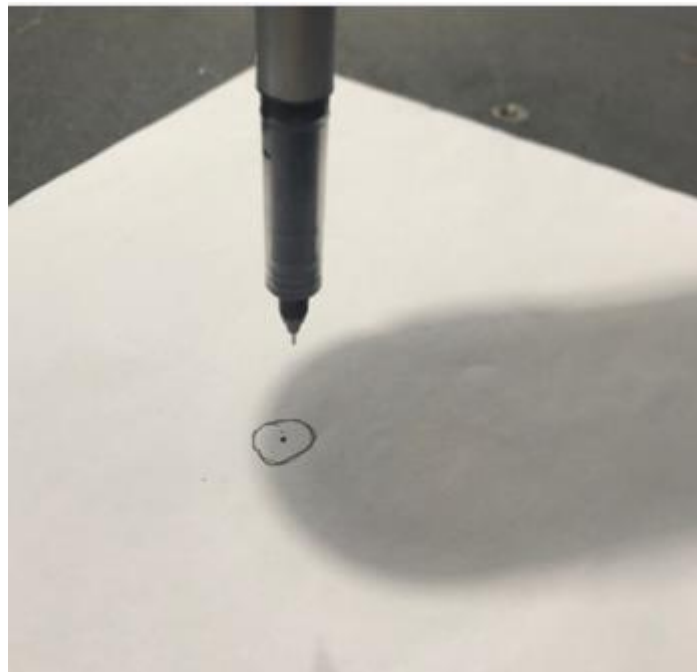

Figure 7.20 Calibration point

Procedure

Step 1 Put the A4 sheet of paper into the workspace of Dobot M1.

Step 2 Click Initialization.exe in the *installation directory* /M1Studio/tools/Initialization directory.

The M1Studio tool page is displayed.

Step 3 Select the corresponding serial port from the serial drop-down list, and click **Connect**.

If **Connect** turns to **Disconnect**, the connection is successful, and Dobot M1 can be controlled by M1Studio.

Step 4 Click the  icon of **Motor** on the **Calibration** page to make the motor of Dobot M1 in the open-loop state.

Step 5 Jog Dobot M1 by hand.

Move Dobot M1 with righty hand orientation to touch the calibrated point that is on the A4 sheet of paper, as shown in Figure 7.21.



Figure 7.21 Calibration as righty hand orientation

Step 6 Click P1 on the Calibration page to save the point in **Step 5**.

The value of **P1** is J2 coordinate with righty hand orientation, as shown in Figure 7.22.

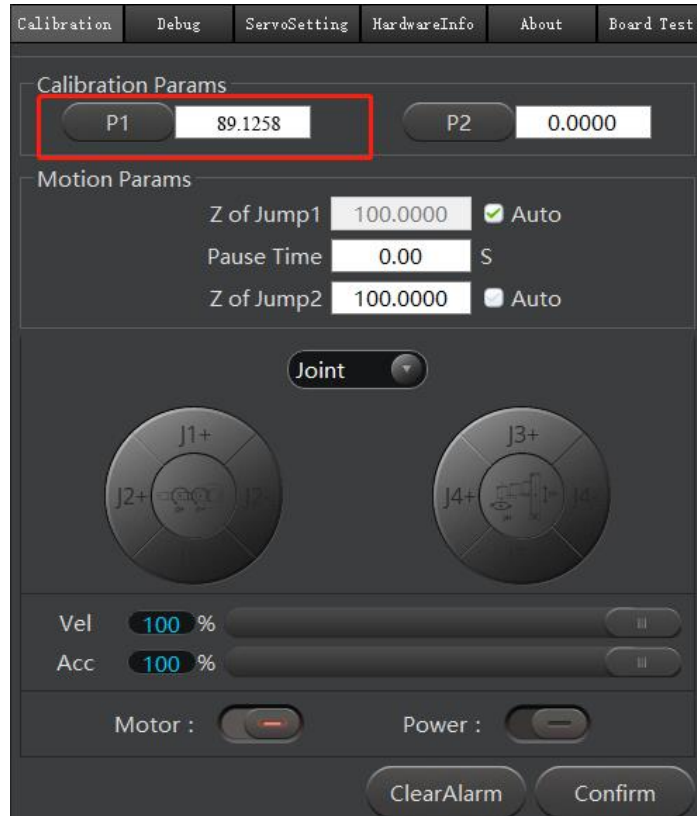

Figure 7.22 Save J2 coordinate with righty hand orientation

Step 7 Jog Dobot M1 by hand to the same point in **Step 5** with lefty hand orientation, as shown in Figure 7.23.



Figure 7.23 Calibration with righty hand orientation

Step 8 Click P2 on the Calibration page to save the point in **Step 7**.

The value of **P2** is J2 coordinate with lefty hand orientation, as shown in Figure 7.24.

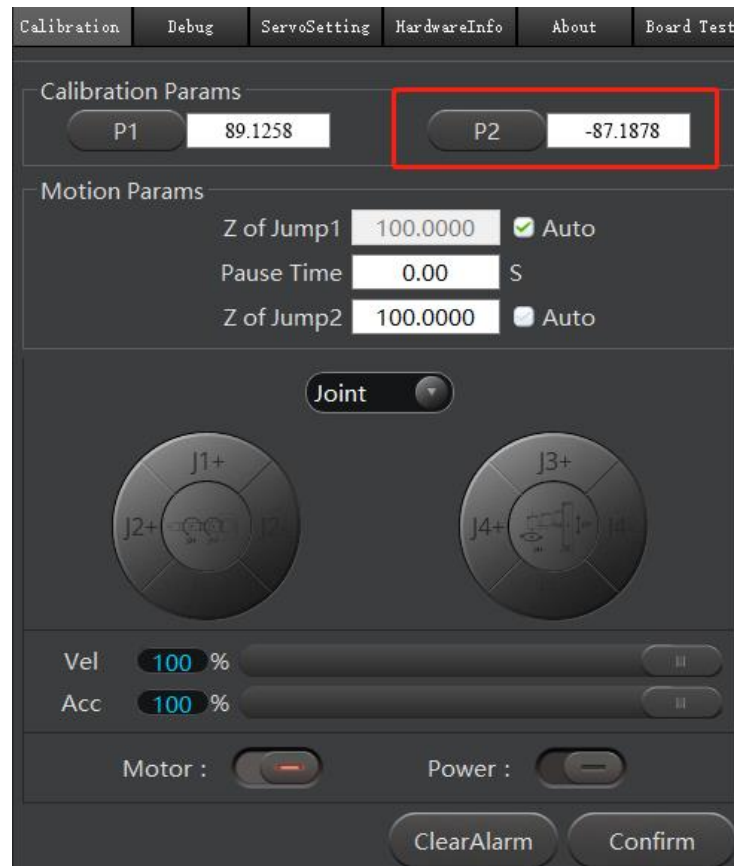



Figure 7.24 Calibration as lefty hand orientation

Step 9 Click the  icon of **Motor** on the **Calibration** page to make the motor of Dobot M1 in the close-loop state.

 **NOTICE**

After saving P1 and P2, you cannot click **Confirm** until the motor of Dobot M1 is in the close-loop state.

Step 10 Click **Confirm** to make Dobot M1 move according to the calibrated point. Dobot M1 will finally move to (400,0,100,0).

 **DANGER**

Dobot M1 starts to work after clicking **Confirm**. Please do not enter the workspace of the robotic arm, otherwise it will be vulnerable to injury the device or the person.