

Christmas Tree (Order code 70-1000)

The Christmas tree circuit consists of two separate astable multivibrators. The frequency at which each circuit flashes is controlled by the value of the capacitor and charging resistor.

The frequency or speed of the oscillator depends on how fast the capacitors (C1 - C2) charge and discharge. Increasing the value of the capacitors will slow down the flashing and decreasing the value of capacitors will increase the flashing rate.

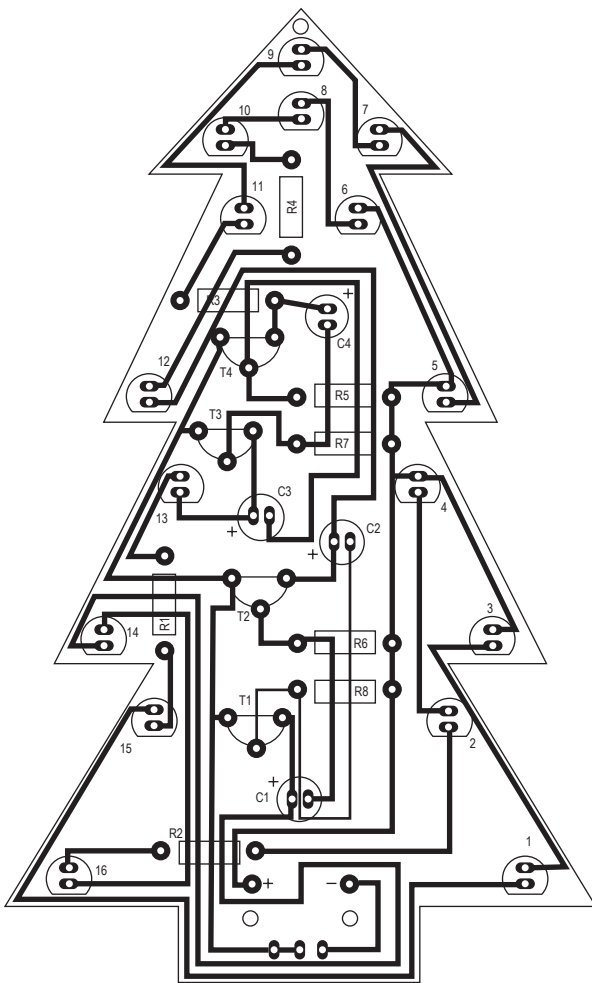
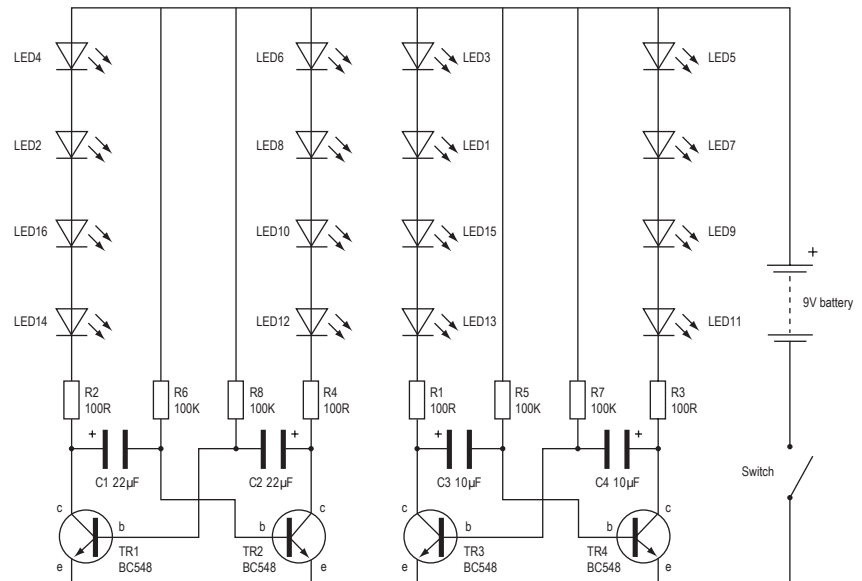

How to build your circuit

Solder in the components in the following order to help you build your Christmas tree circuit successfully:

1. Resistors

R1, R2, R3, R4 = 100R (Brown, Black, Brown)
R5, R6, R7, R8 = 100K (Brown, Black, Yellow)

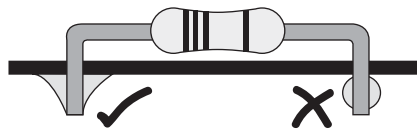

Make sure that the resistors are bent and soldered carefully when inserting them in the circuit board.

2. LEDs

Make sure they are soldered in the correct way round. The anode is the positive connection and can be identified by the longer leg.

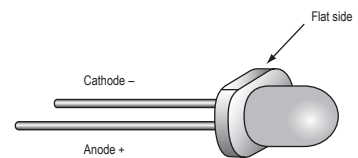

3. Capacitors

The cathode or negative leg can be identified since it is shorter than the positive leg and has a light stripe next to it on the case.

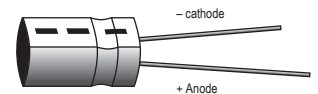

4. Transistors

There are three connections on a transistor, the collector (c), the base (b), and the emitter (e). Take care not to push the transistor in too far.

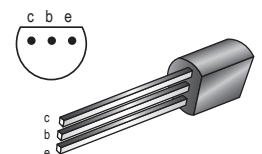

5. Switch

Solder the switch in place so it faces the base of the Christmas tree.

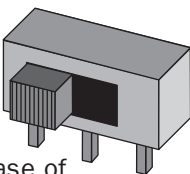

6. Battery Clip

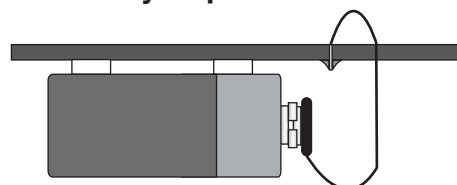

Pass the battery clip wires through the two holes in the circuit board from the back to the front, taking care to connect them the correct way. The battery (not included) should be attached to the solder side of the circuit board by using two sticky pads.

Task: Describe two methods of increasing or decreasing the flashing rate of your Christmas tree circuit