

Total solder points: 47
Difficulty level: *beginner* 1 2 3 4 5 *advanced*

METAL DETECTOR

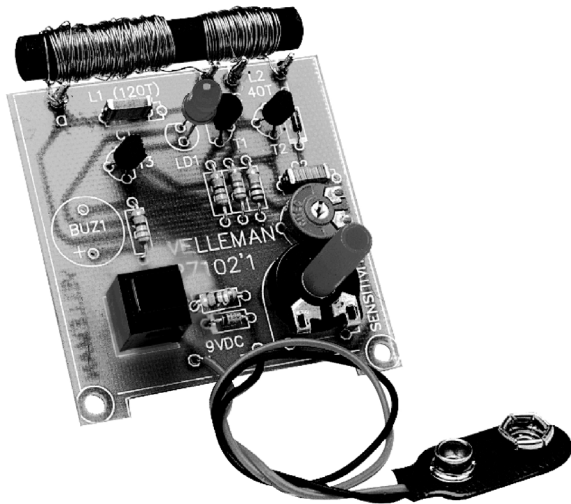

K7102

Avoid disasters when drilling
holes in walls...

To come up against an electric cable while drilling a hole in a wall can have catastrophic consequences. Likewise, drilling into gas, water pipes or central heating pipes can be extremely hazardous. With a handy metal detector it can now be determined beforehand whether there are metal objects to be found in a wall, ceiling or floor. An LED indicates if a metal object is in the vicinity.

Specifications:

- Avoid disasters when drilling holes in walls
- Locate pipes, cables, metal studs, ...
- Great project for novices
- Your own unique application
- Push button operation

Features:

- Detection range adjustable up to 8cm/ 3.1"
- Power supply : 9V battery
- Power consumption : 30mA max.
- LED indicator
- 12VDC-buzzer connection (*buzzer not included*)
- Dimensions : 55x64mm / 2.2"x2.5"

1. Assembly (Skipping this can lead to troubles !)

Ok, so we have your attention. These hints will help you to make this project successful. Read them carefully.

1.1 Make sure you have the right tools:

- A good quality soldering iron (25-40W) with a small tip.
- Wipe it often on a wet sponge or cloth, to keep it clean; then apply solder to the tip, to give it a wet look. This is called 'thinning' and will protect the tip, and enables you to make good connections. When solder rolls off the tip, it needs cleaning.
- Thin raisin-core solder. Do not use any flux or grease.
- A diagonal cutter to trim excess wires. To avoid injury when cutting excess leads, hold the lead so they cannot fly towards the eyes.
- Needle nose pliers, for bending leads, or to hold components in place.
- Small blade and Phillips screwdrivers. A basic range is fine.

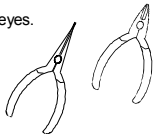
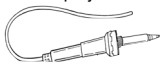

For some projects, a basic multi-meter is required, or might be handy

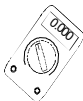

1.2 Assembly Hints :

- ⇒ Make sure the skill level matches your experience, to avoid disappointments.
- ⇒ Follow the instructions carefully. Read and understand the entire step before you perform each operation.
- ⇒ Perform the assembly in the correct order as stated in this manual
- ⇒ Position all parts on the PCB (Printed Circuit Board) as shown on the drawings.
- ⇒ Values on the circuit diagram are subject to changes, the values in this assembly guide are correct*
- ⇒ Use the check-boxes to mark your progress.
- ⇒ Please read the included information on safety and customer service

* Typographical inaccuracies excluded. Always look for possible last minute manual updates, indicated as 'NOTE' on a separate leaflet.

1.3 Soldering Hints :

1- Mount the component against the PCB surface and carefully solder the leads

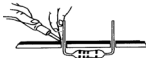

2- Make sure the solder joints are cone-shaped and shiny



3- Trim excess leads as close as possible to the solder joint



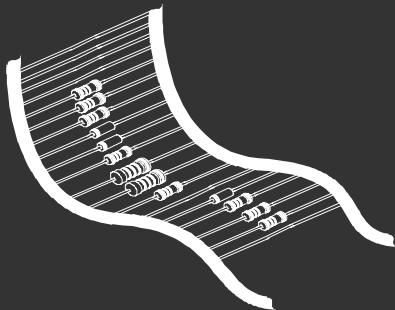

REMOVE THEM FROM THE TAPE ONE AT A TIME !

Included in this kit

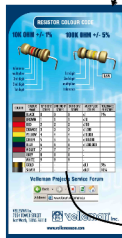

2. RESISTOR

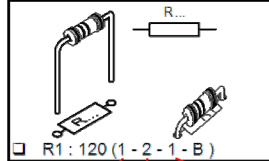

COLOUR	COLOUR NAME	1ST DIGIT/ STRIPE	2ND DIGIT/ STRIPE	3RD DIGIT/ STRIPE	MULTIPLIER STRIPE	TOL. 4TH!
	BLACK	0	0	0	x1	1%
	BROWN	1	1	1	x10	
	RED	2	2	2	x100	
	ORANGE	3	3	3	x1.000	
	YELLOW	4	4	4	x10.000	
	GREEN	5	5	5	x100.000	
	BLUE	6	6	6	x1.000.000	

**DO NOT BLINDLY FOLLOW THE ORDER OF THE COMPONENTS ONTO THE TAPE.
ALWAYS CHECK THEIR VALUE ON THE PARTS LIST!**

1. Coils

The coil consists of two windings around the ferrite core supplied.

In order to facilitate winding, thin double sided sticky tape can be stuck to the ferrite core, each winding can be held down using ordinary sellotape.

Both windings must be wound in the same direction (see fig 1.0)

- Winding L1 = 120 turns
(this winding can be marked with a sticky label)
- Winding L2 = 43 turns.

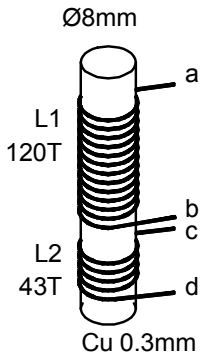
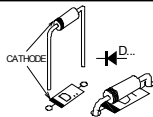

Fig. 1.0

2. Diode. Watch the polarity !

- D1 : 1N4148



3. Zenerdiode. Watch the polarity !

- ZD1 : 3V9

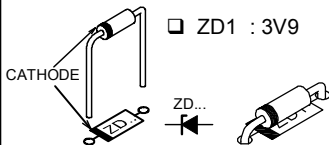

4. Resistors

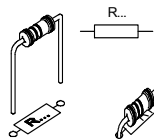

- R1 : 330 (3 - 3 - 1 - B)
- R2 : 470 (4 - 7 - 1 - B)
- R3 : 470 (4 - 7 - 1 - B)
- R4 : 2K7 (2 - 7 - 2 - B)
- R5 : 10K (1 - 0 - 3 - B)

5. Capacitors.

Choose C1 :

- C1 : 1n2 (122)
- C1 : 3n3 (332)

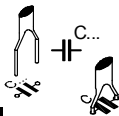

Experiment for best result

- C2 : 47nF (473)

6. Transistors.

- T1 : BC547B
- T2 : BC547B
- T3 : BC547B

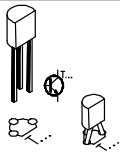

7. LED. Watch the polarity!

- LD1 : 5mm RED

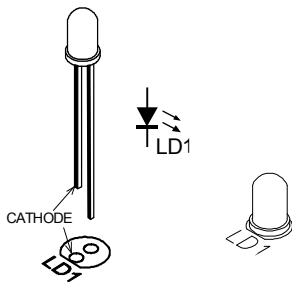

8. Trim potentiometers

- RV1 : 2K5
- RV2 : 100

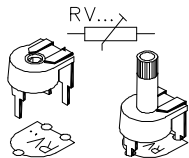

9. Push button

- SW1

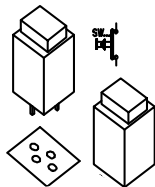

10. Assembly

- ❑ Connect the battery terminal to the point marked “+” (red) and “-” (black), see figure 2.0.

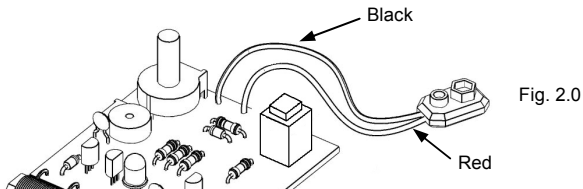

- ❑ Connect the windings to their respective points marked with a, b, (L1) and c, d (L2), see figure 3.0.

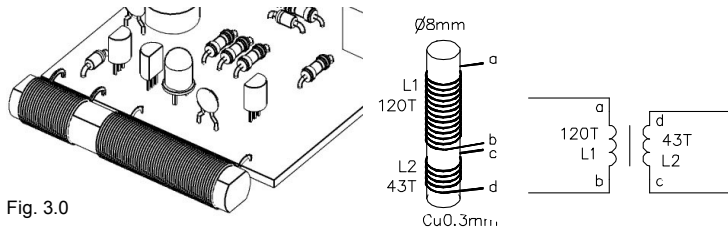

11. Test & final adjustments

1. Connect a 9V battery to the battery holder.
2. Go to a place where NO metal object is known to be in the vicinity.
3. Turn preset RV1 fully clockwise.
4. Turn RV2 fully anti-clockwise.
5. Depress the push button and hold it in during the final adjustments.
6. Turn RV1 anti-clockwise until the LED goes out.

☞ All further remaining adjustments are now concerned with RV2 only.

To set to maximum sensitivity: turn RV2 until the LED is weakly lit. When the detector now comes into the vicinity of a metal object, the LED will be more brightly lit. This gives an indication of the distance and/or the size of the metal object.

12. PCB layout.

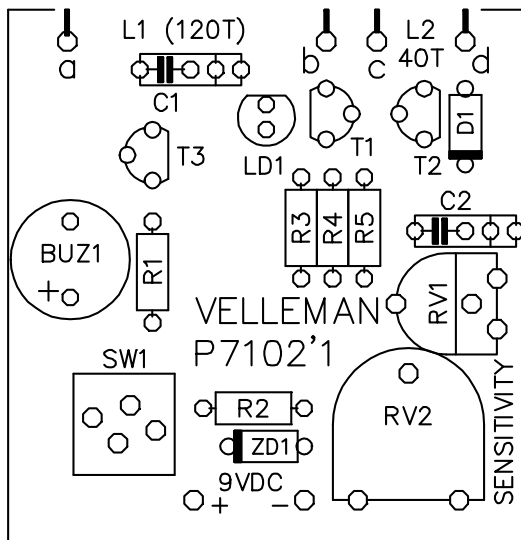

13. Diagram

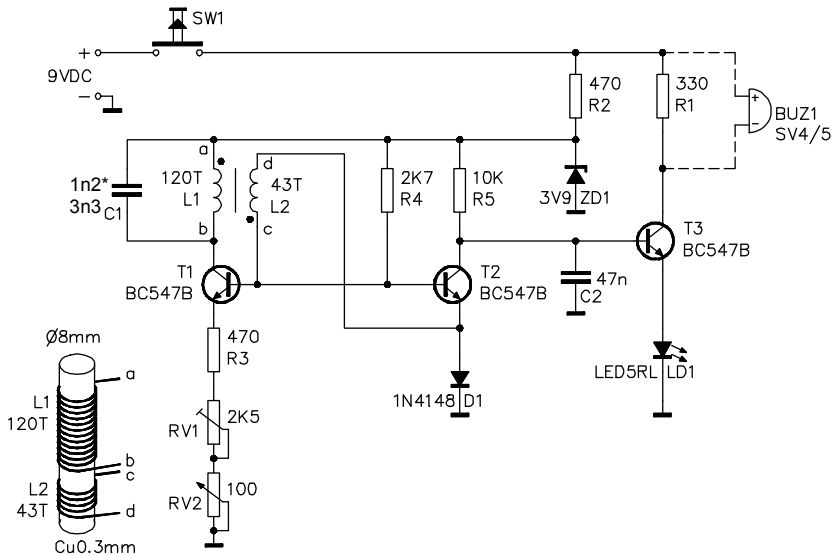



VELLEMAN NV
Legen Heirweg 33
9890 Gavere
Belgium Europe
www.velleman.be
www.velleman-kit.com

EDU 01**SOLDERLESS EDUCATIVE STARTERBOX**

The EDU01 basic experiment kit is the first step into the world of modern electronics. Build your own circuits in a fun, safe and educative way.

AVAILABLE**EDU 02****SOLAR ENERGY EXPERIMENT KIT**

Fun solar powered projects. Learn all about solar energy.

AVAILABLE**EDU 03****SOLDER EDUCATIVE STARTER BOX**

Learn how to solder, build different exciting projects. Includes spare components and demo boards.

COMING SOON**EDU 04****PIC™ TUTOR KIT**

Enter the world of microcontroller programming, easy step by step instructions. Includes programmer and test board.

The Microchip name and logo, PIC, and PICmicro are registered trademarks of Microchip Technology Inc. in the USA and other countries.

COMING SOON**EDU 05****USB TUTOR BOARD**

Learn how to connect your computer with the outside world, master the USB communication with tutorial examples. Play with LED indicators and learn how to drive LCD displays.

COMING SOON**EDU 06****SCOPE EDUKIT**

This board with different signals will teach you how to use an oscilloscope. Optimized instructions for use of our HPS140 oscilloscope. YouTube demo movies.

COMING SOON