

LED CLOCK with SLOW ON DIMMER

Attractive LED clock with nightlight connection

Total solder points: 120

Difficulty level: *beginner* 1 2 3 4 5 *advanced*



K8091EU

The K8091 is an attractive LED clock with connection possibility for a nightlight. 15 minutes before the set time, the light intensity of the connected light will increase up to full power at set time and beeps will be heard. The beep length is gradually built up so you will not be startled by a sudden alarm signal.

Features :

- ☑ clock with red 7-segment display.
- ☑ possibility to connect any lamp armature fitted with an incandescent light bulb
- ☑ sleep function (15 min) for slow light power-off.
- ☑ snooze function with alarm repeat function after 8 min.
- ☑ manually settable light intensity.
- ☑ beep and / or light option.

Specifications

- power supply: 220- 240V AC / 50Hz.
- lamp power: 40 ~ 100W max.
- power consumption: < 1W (without lamp)
- dimensions: 92x45x101mm / 3.6x1.8x3.9"



WARNING !

ALL PARTS IN THIS KIT CARRY HAZARDOUS VOLTAGES WHICH CAN KILL !

Do not touch any part of the kit while connected to the AC grid.

Do not modify the kit in any way.

Do not use the kit if the enclosure is damaged or open.

For use with regular incandescent lightbulbs (40-100W) only.

Not suited for low-voltage halogen lighting, energy saving bulbs, led lighting, fluorescent lighting, motors, buzzers, transformers etc...

We highly recommend to have your kit inspected by a qualified technician before connecting it to the AC power for the first time or after a malfunction.

1. Assembly (Skipping this can lead to troubles !)

Ok, so we have your attention. These hints will help you to make this project successful. Read them carefully.

1.1 Make sure you have the right tools:

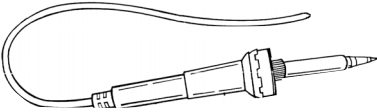
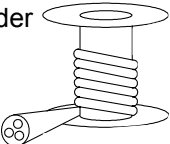
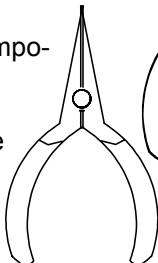
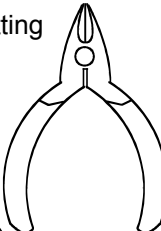
- A good quality soldering iron (25-40W) with a small tip. 
- Wipe it often on a wet sponge or cloth, to keep it clean; then apply solder to the tip, to give it a wet look. This is called 'thinning' and will protect the tip, and enables you to make good connections. When solder rolls off the tip, it needs cleaning.
- Thin raisin-core solder. Do not use any flux or grease. 
- A diagonal cutter to trim excess wires. To avoid injury when cutting excess leads, hold the lead so they cannot fly towards the eyes.
- Needle nose pliers, for bending leads, or to hold components in place. 
- Small blade and Phillips screwdrivers. A basic range is fine. 



For some projects, a basic multi-meter is required, or might be handy

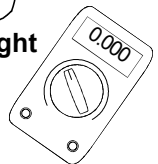

1.2 Assembly Hints :

- ⇒ Make sure the skill level matches your experience, to avoid disappointments.
- ⇒ Follow the instructions carefully. Read and understand the entire step before you perform each operation.
- ⇒ Perform the assembly in the correct order as stated in this manual
- ⇒ Position all parts on the PCB (Printed Circuit Board) as shown on the drawings.
- ⇒ Values on the circuit diagram are subject to changes.
- ⇒ Values in this assembly guide are correct*

- ⇒ Use the check-boxes to mark your progress.
- ⇒ Please read the included information on safety and customer service

* Typographical inaccuracies excluded. Always look for possible last minute manual updates, indicated as 'NOTE' on a separate leaflet.

1.3 Soldering Hints :

1- Mount the component against the PCB surface and carefully solder the leads

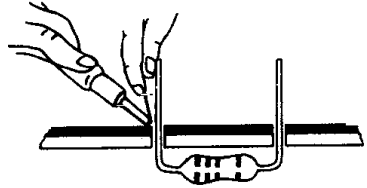

2- Make sure the solder joints are cone-shaped and shiny

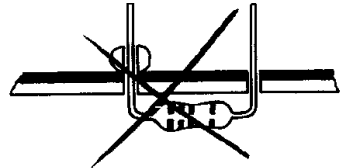
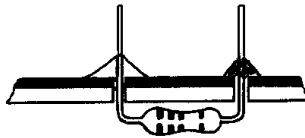

3- Trim excess leads as close as possible to the solder joint

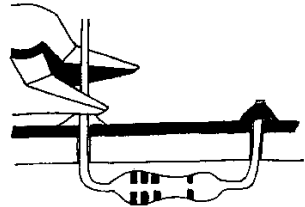

AXIAL COMPONENTS ARE TAPED IN THE CORRECT MOUNTING SEQUENCE !

REMOVE THEM FROM THE TAPE ONE AT A TIME !

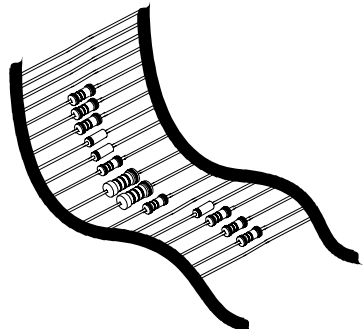

(1) ASSEMBLY OF THE COMPONENT SIDE

1. Resistors

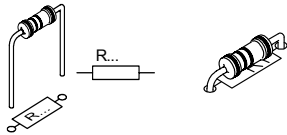

1/8W:

- R1 : 100 (1-0-1-B)
- R2 : 100 (1-0-1-B)
- R3 : 100 (1-0-1-B)
- R4 : 100 (1-0-1-B)
- R5 : 100 (1-0-1-B)
- R6 : 100 (1-0-1-B)
- R7 : 100 (1-0-1-B)
- R13 : 10K (1-0-3-B)
- R14 : 10K (1-0-3-B)
- R16 : 10 (1-0-0-B)

1/2W "metal film":

- R8 : 47 (4-7-0-B-9)
- R9 : 10 (1-0-0-B-9)
- R10 : 470K (4-7-4-B-9)
- R11 : 470K (4-7-4-B-9)
- R12 : 100K (1-0-4-B-9)

1/4W:

- R15 : 220 (2-2-1-B)

2. Diodes (check the polarity)

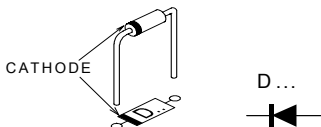

- D1 : 1N4148
- D2 : 1N4148
- D3 : 1N4148
- D4 : 1N4148
- D5 : 1N4007

3. Zener diode (check the polarity)

- ZD1 : 15V0

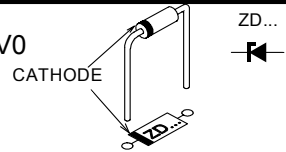

4. IC socket. Watch the position of the notch!

- IC1 : 18p

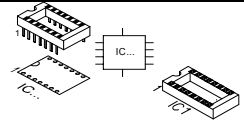

Mind the position of the notch and shorten the connection pins as short as possible after soldering!

5. Capacitors

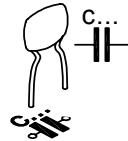

- C1 : 100nF (104)
- C2 : 100nF (104)
- C3 : 100nF (104)
- C4 : 10nF (103)
- C5 : 100pF (101)

6. Fuse.

- F1 : 1A

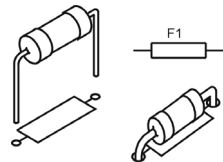

7. Buzzer

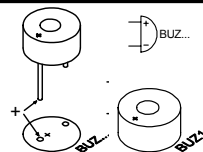

- BUZ1(3-6VDC/25mA)

8. Transistor

☐ T1 : BC547

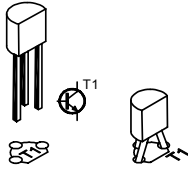

9. Voltage regulator

☐ VR2 : UA78L05

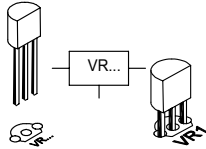

10. 1W Resistor

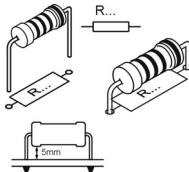

☐ R17 : 220 (2 - 2 - 1 - B)

11. Electrolytic capacitors. Watch the polarity !

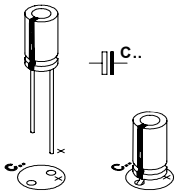

☐ C8 : 220 μ F
☐ C9 : 10 μ F

12. Terminal blocks

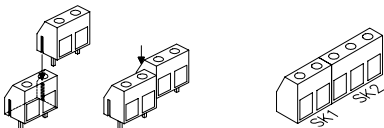

☐ SK1 : 2p (AC IN)
☐ SK2 : 2p (output)

13. Capacitors

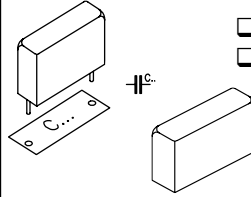

☐ C6 : 100nF
☐ C7 : 470nF

14. Push buttons

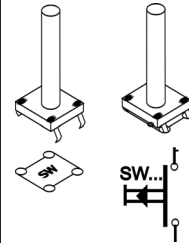

☐ SW1
☐ SW2
☐ SW3

15. Triac

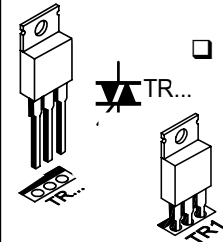

☐ TR1 : BT136

16. IC

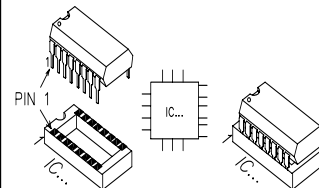

☐ IC1: VK8091EU
Programmed PIC16F627A

(2) MOUNT THESE COMPONENTS ON THE PCB SOLDERSIDE, SOLDER THEM ON THE COMPONENTS SIDE

1. Four digit display & coil

- Mount the four digit display first.

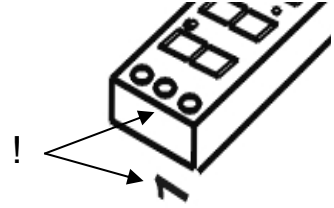
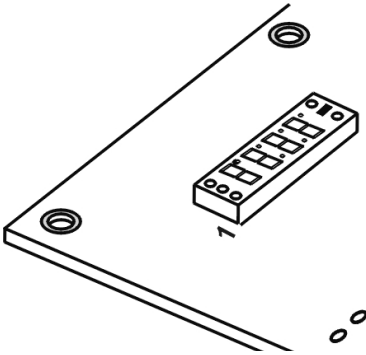

□ DY1 : 4-digit

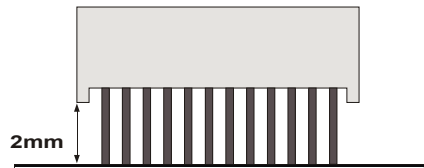

- Mounting the coil:

- 1) Cut the rubber foot and stick it to the PCB as shown.
- 2) Position the coil onto the rubber foot. Bend the leads carefully and insert them into their soldering pads. Solder carefully.

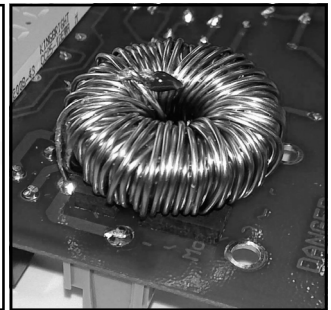
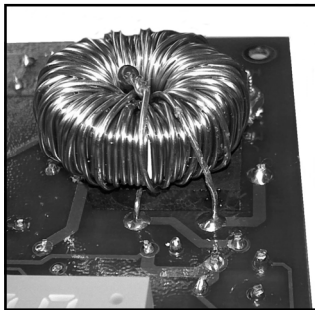
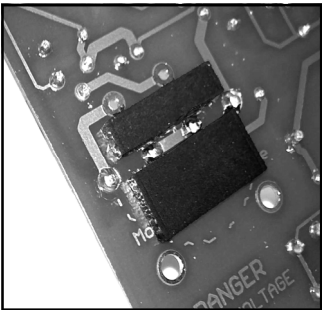

2. Power cable

- Cut 45cm of the included cable, measured from the female connector.

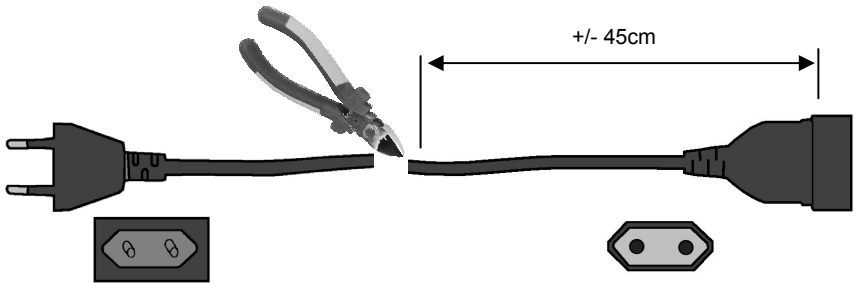

- Put both cables trough the hole on the rear cover of the housing.
- Strip the male and female cable.
- Connect the female cable/connector to the output connector SK2, the male cable/connector to output connector SK1
- When both cables have been connected to the K8091EU mount the strain relief and tighten up with the included 15mm bolts and M3 nuts.

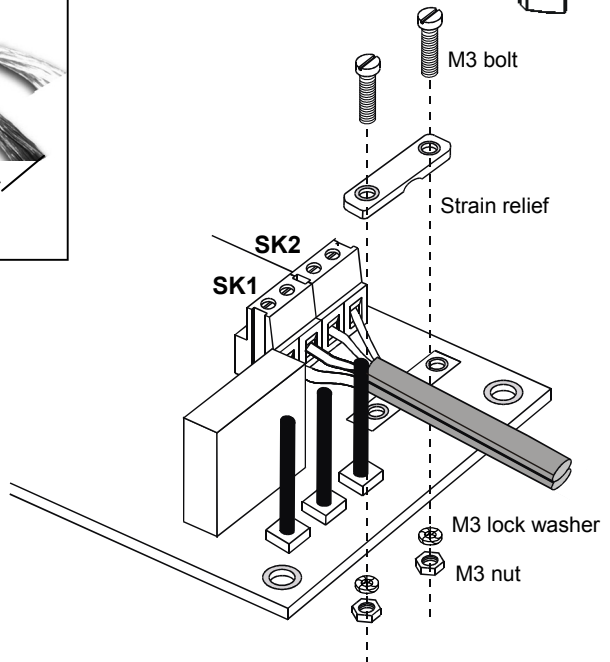
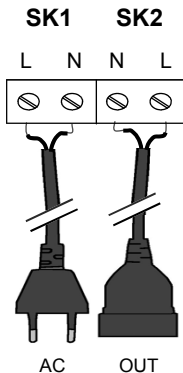
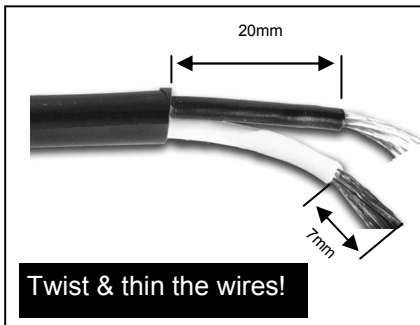
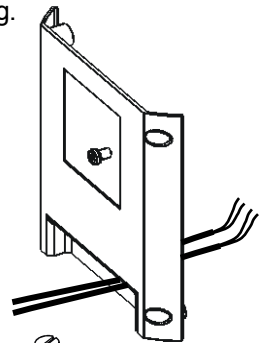

3. Assembly

- Before mounting the PCB on its place you must mount the red display.
- After placing the red display mount the PCB in the front cover with the 4-digit display facing to the red display window with 4 screws.
- At last mount the rear of the housing and closed with 4 screws.

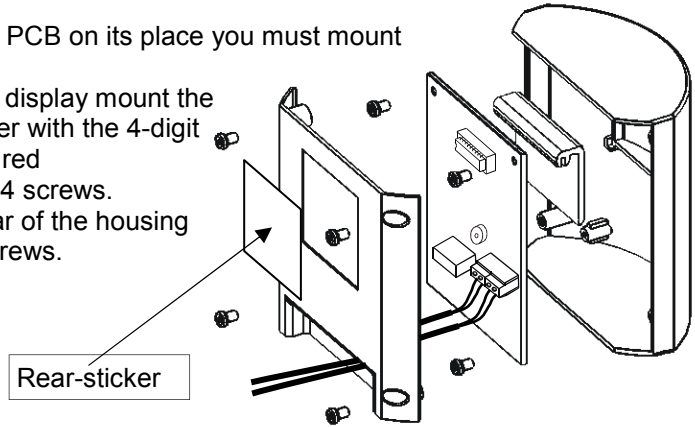

Stick the rear sticker on the backside of the housing, see figure.

Product description

Indications :

- (a) time set
- (b) alarm set
- (c) light/buzzer

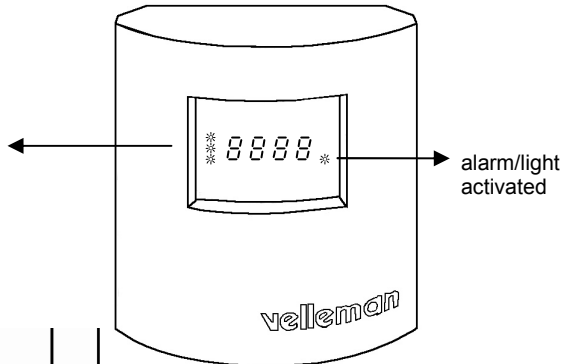

Control :

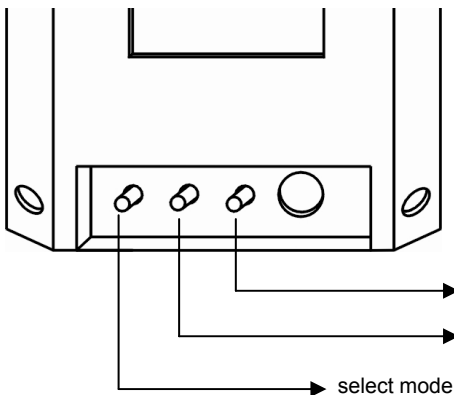

Light / Buzzer	time	run mode
sleep / snooze	hour	on
dim / cancel alarm	minutes	off

4. Connection

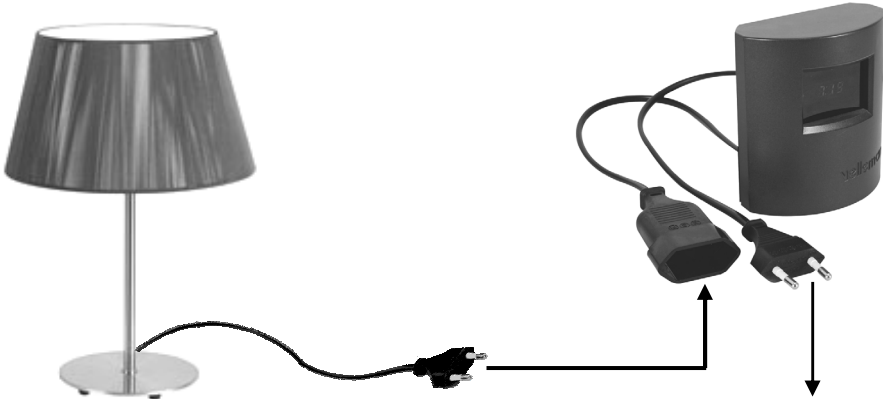

lamp power: 40 ~ 100W

power supply: 220- 240V AC / 50Hz.

5. First power-up

At first power-up

Make sure to read and understand the important safety information on p. 3
At first power-up the product number 8091 and version software appear.

Default setting

The default setting is the blinking clock time 0:00 with a default alarm time 07:00 and alarm functions (light+buzzer) deactivated.

Note: From the moment that the alarm time is changed will this time be the default setting alarm time.

6. Setting time / alarm / alarm functions

Time-setting:

- First press the "select" button to enter the time set mode, the 'time set' indicator will blink.
- Press the middle button to set the minutes, the right button for the hours.
- Confirm the setting by pressing the select-button, once confirmed you will automatic enter the alarm-mode.

Alarm:

Note: If you are not entering this mode after the time setting you must press twice the 'select' button to enter the alarm mode. The 'alarm set' indicator blinks to confirm you're in the alarm mode.

- Press the middle button to set the minutes, the right button for the hours.
- Confirm the setting by pressing the select-button, once confirmed you will automatic enter the alarm function mode.

Alarm functions:

Note: If you are not entering this mode after the alarm setting you must press three times the 'select' button to enter the alarm mode.

The 'alarm set' indicator blinks to confirm when you're in the alarm mode.

You can choose between 3 possibilities for wake-up alarm :

1. Light (*LI.on* or *LI.oF*)
2. Buzzer (*bU.on* or *bU.oF*)
3. Light & Buzzer

Note: Press the "select" button to go trough the setup mode and to exit.

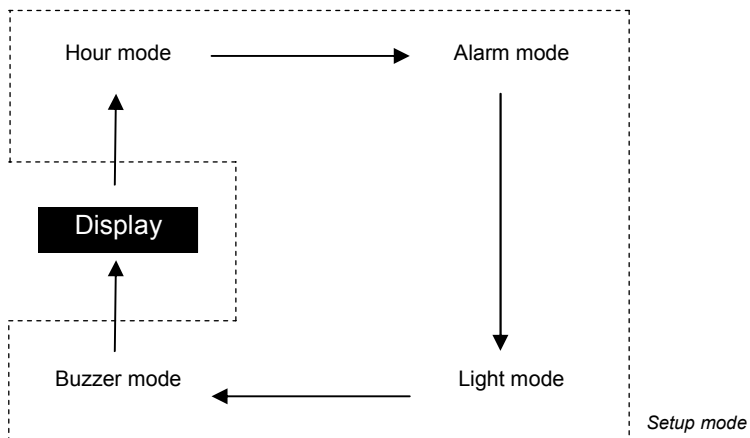
SETUP SEQUENCE:

Make sure that the switch of your nightlight is activated!

7. Alarm process

SEQUENCE:

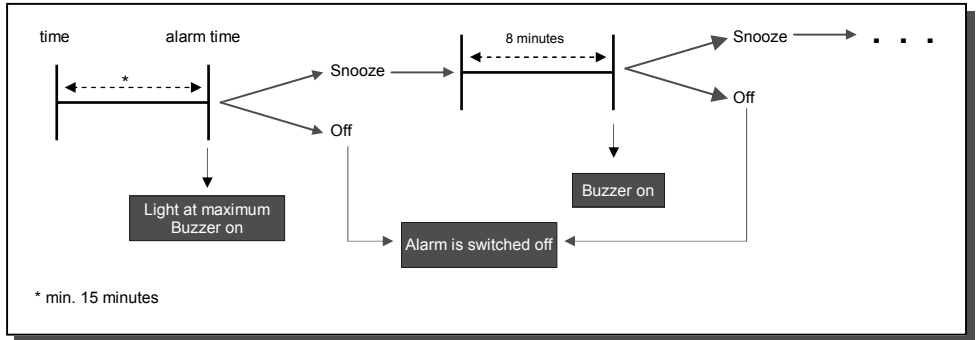

The repeat function of the buzzer will automatically repeat every 8 minutes until the alarm is deactivated by pressing the manual on/off button.

Note: if the light was already illuminated more than 15 minutes before the alarm time, will the alarm-light increase from that point to its maximum.

8. Manual light control

The nightlight can be switched on through the alarm or manually.

When you want to do it manually you can let it light up or down in gradation or directly to 100% or directly extinguish the light.

Letting the light growing up or down in gradation by holding the middle button pressed until the desired level is reached.

With a short press you go directly to the maximum or minimum light intensity.

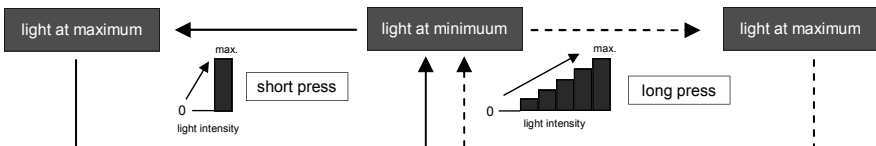

Note: when a short press after a dimming function the light will go directly to its maximum or minimum, the direction will be equal to the last dimming direction.

9. PCB

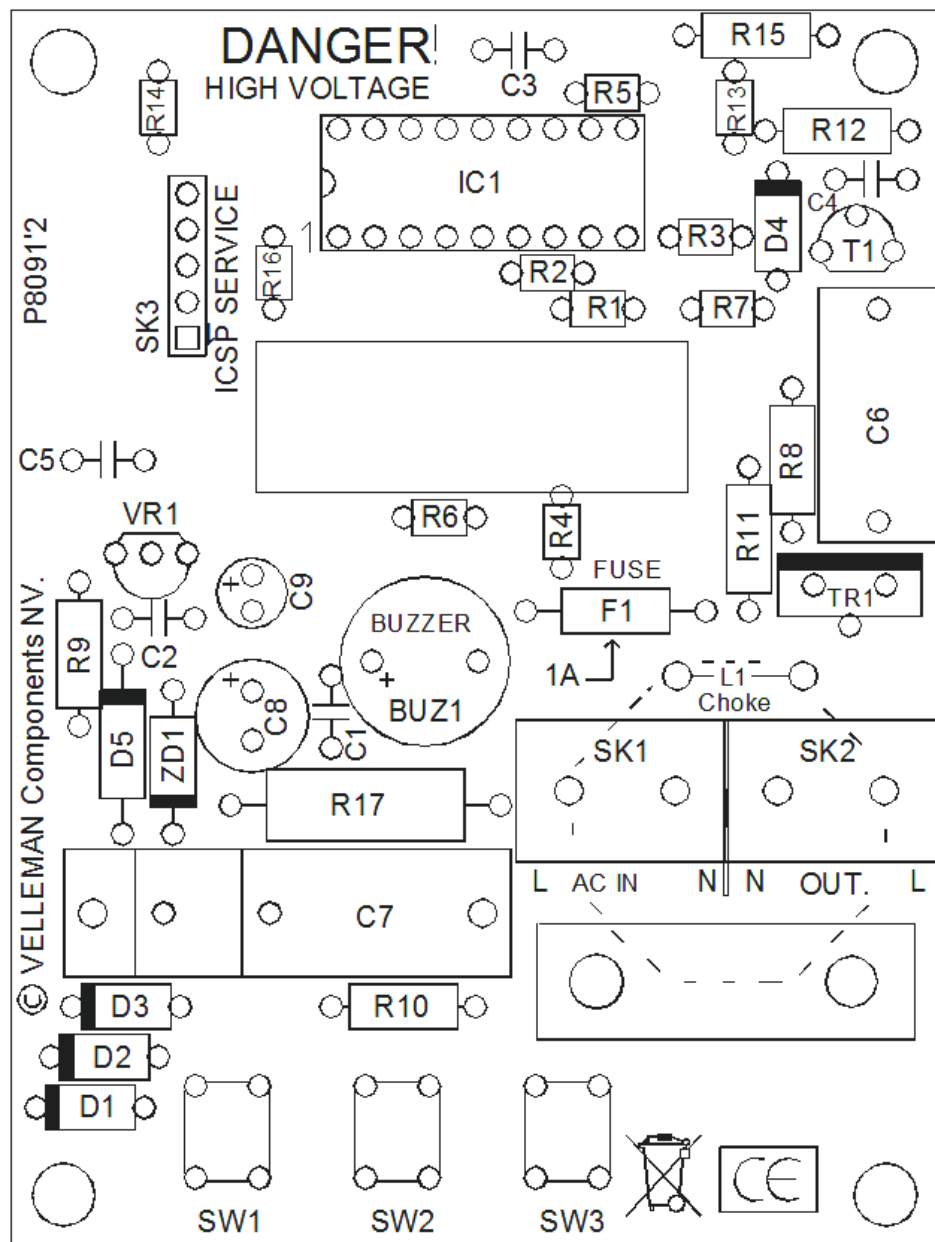

10. Schematic diagram

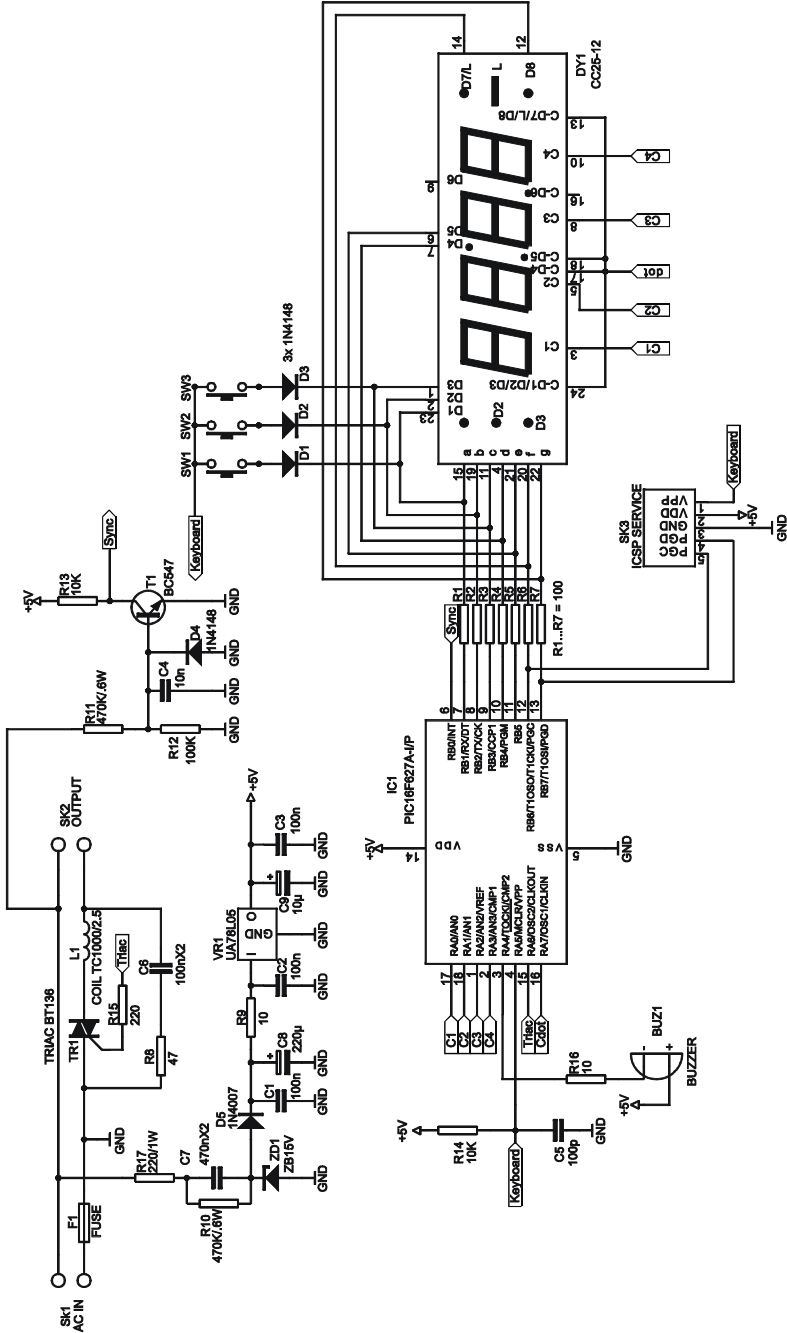



Velleman Home Automation System



**All appliances get intelligent, how about your home?
see our website : www.velbus.be**

**VELLEMAN KIT NV
Legen Heirweg 33
9890 Gavere
Belgium Europe
Info ? : <http://www.velleman.be>**

Modifications and typographical errors reserved
© Velleman Kit nv
H80911P - 2009

