

RKPT18 Project board

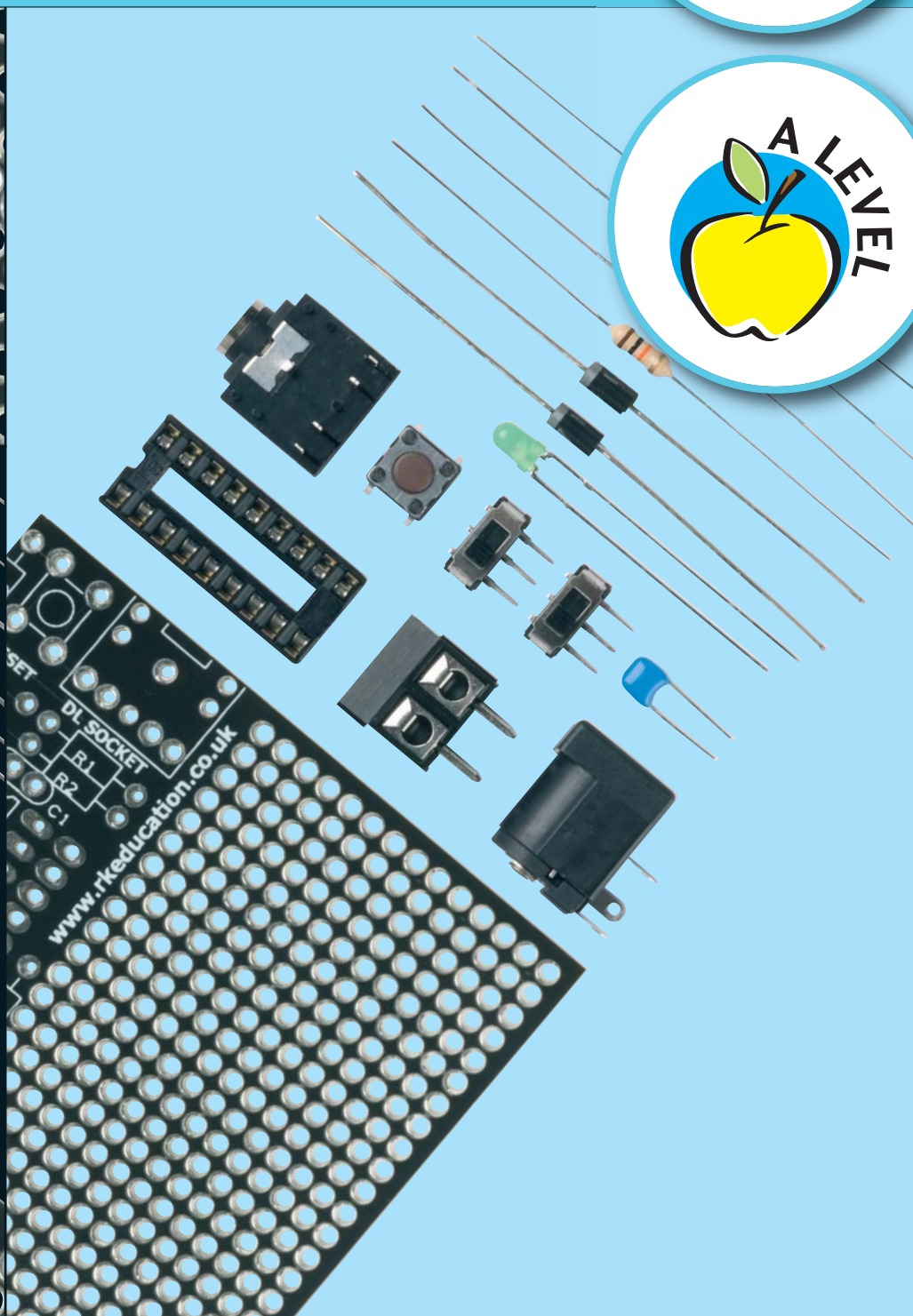
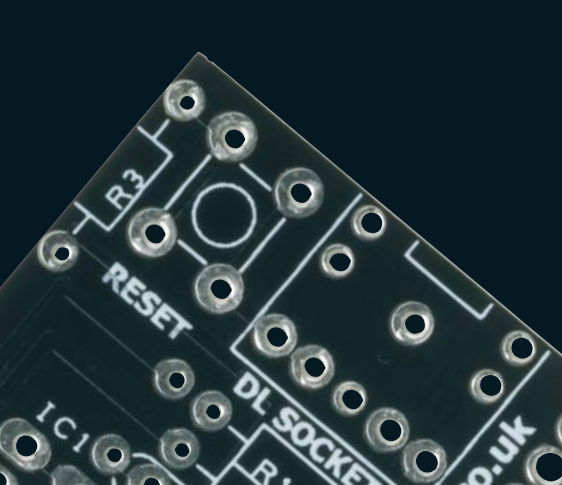
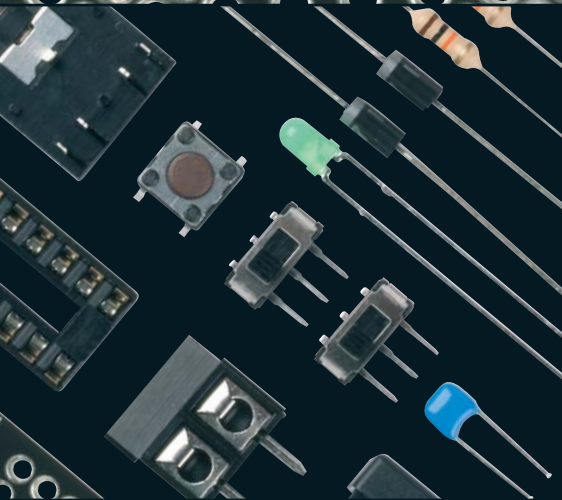
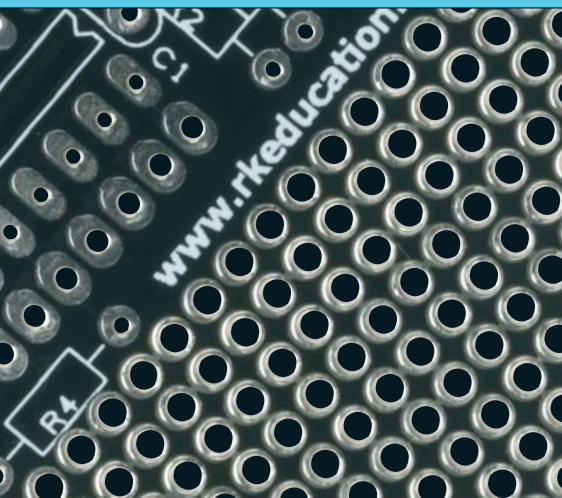

Component list and instructions for:

RKPT18

70-6004

Rapid

RKPT18 Component list and instructions

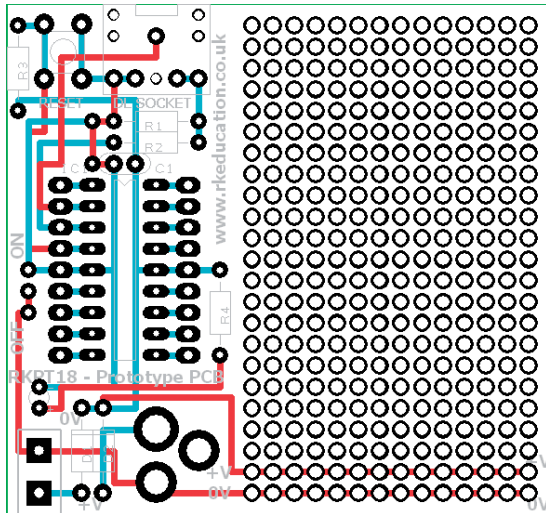

PCB layout

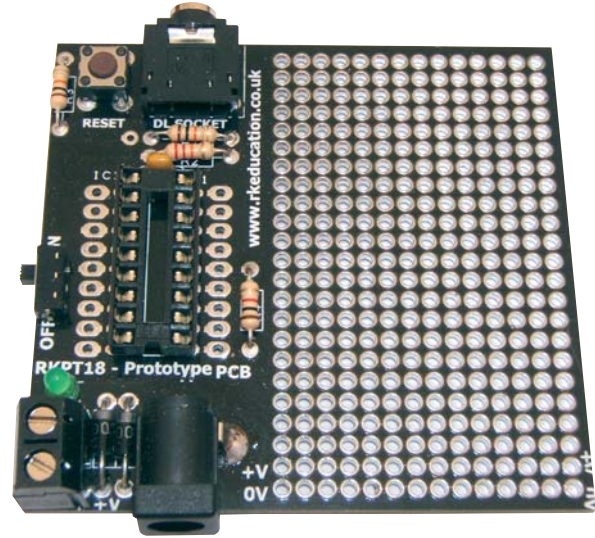

Constructed PCB

Description

The RKPT18 prototype project PCB has been designed to use PIC microcontrollers such as the kicchip from www.kicchip.co.uk

- The software is downloaded from a PC into the microcontroller via a 3.5mm stereo socket
- The clock reference is from the microcontroller's internal resonator
- All input and output pins have a PTH
- A large prototyping area
- Power rails on the prototyping area
- Power a terminal block or DC power socket
- Power switch and LED power indicator

Component list

TB1 – 2-way 5mm pitch terminal block for power supply
C1 – 100nF multilayer ceramic capacitor
D1 & D2 – 1N4007
IC1 – 18-way DIP socket with microcontroller e.g. kicchip
R1 & R3 – 10k (brown black orange)
R2 – 22k (red red orange)
R4 – 1k (brown, black, red)
RESET – PCB mounting tactile switch
DL SOCKET – PCB mount 3.5mm stereo connector
3mm green LED for power indicator
Ultra miniature slide switch for power switch

Instructions

The chip shown on the PCB is a kicchip, for instructions on using your chosen microcontroller please see the appropriate website – www.kicchip.co.uk

Connecting power

The power is connecting the terminal block, the 0V input, usually black is marked clearly as is +V which is usually red, a regulated 6V DC power supply should be used. Power can also be inputted from a regulated +6 V DC supply via the DC power socket.

A power switch has been included and is to the left of IC1.

Using the prototype area

Using the prototype area is simple and how it is used is dependent on what is being done. Access to all of the pins of IC1 is gained by through holes near the pins of IC1, simply connect using jumper wires. The bottom 2 rows of the prototyping area are connected to 0V and +V and are clearly marked on the PCB.

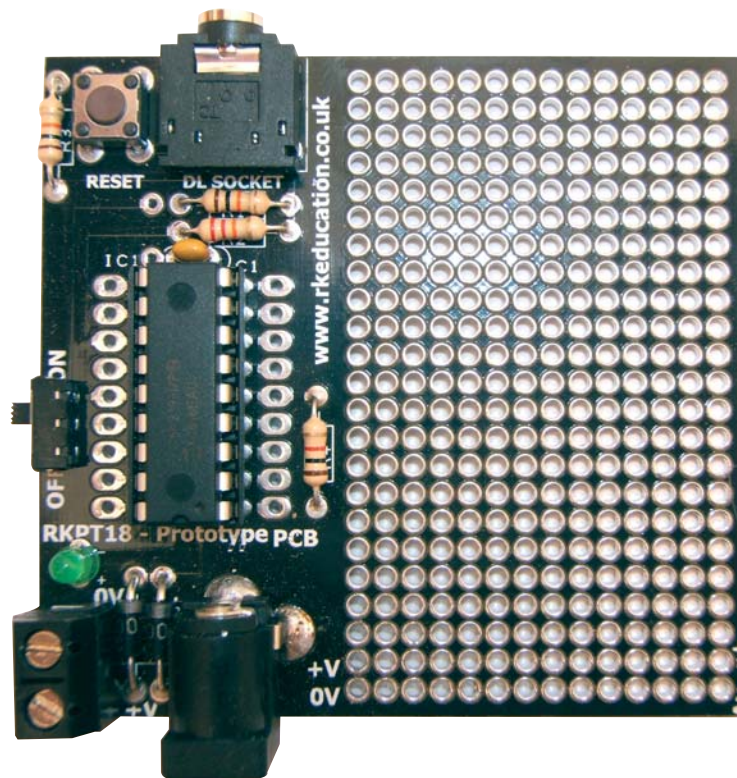

If you have any comments or queries please email us at tech@rapidelec.co.uk