

Rating	16A 125V AC	c7A us	Mounting Hole	Diagram
	10A 250V AC			
Contact Resistance	50m ohm Max.			
Insulation Resistance	DC 500V 100M ohm Min.			
Dielectric Strength	AC 1500V 1 minute			
Operation Temperature	-20°C~85°C			
Switch Function	3P SPST ON-OFF			

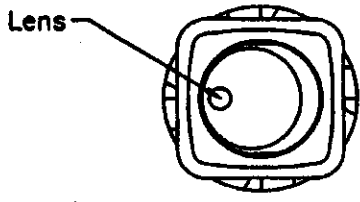

*Material
 Frame: Nylon#66+33%GF, Black
 Actuator: Nylon#66, Black
 Lens: PC
 Terminal: Copper alloy, Silver plated

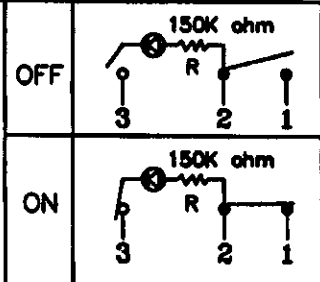
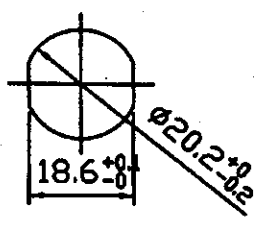
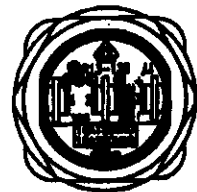
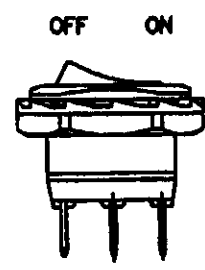
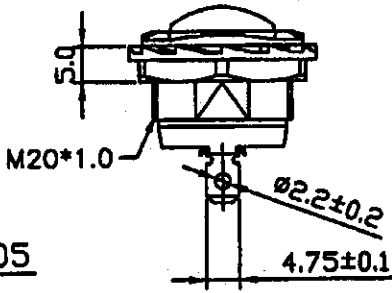
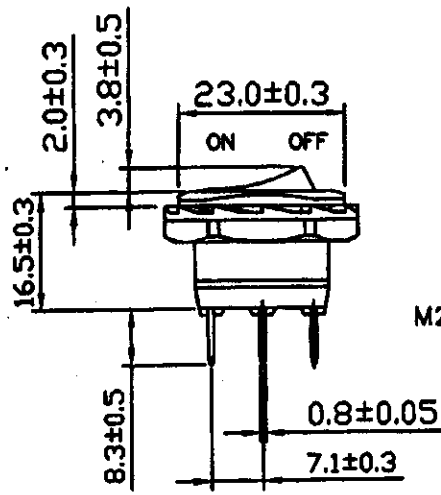

1822457	Orange Clear	Red
1822456	Green Clear	Green
1822455	Red Clear	Red
SCI NO.	Lens Color	Neon Light Color

D:\Ruby\Project\R13-135B2

△	Date	Name	Description			
Drawn	Checked	Approved	SCI No.	SEE TABLE	Model Name	ROCKER SWITCH
徐洲迎	研發部		Customer No.		Model No.	R13-135B2-02
6/27/07	李元生		Unit	mm	SHIN CHIN INDUSTRIAL CO., LTD.	