

R13-508

Screw Type

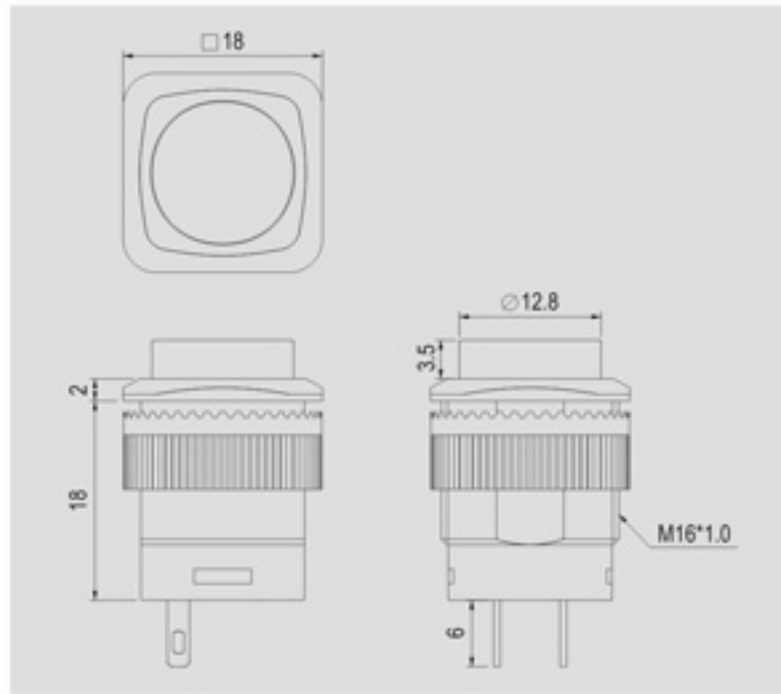

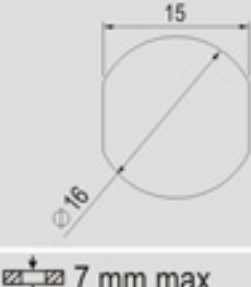



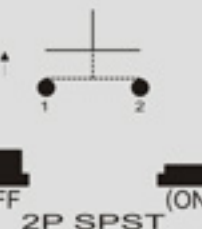

Rating	3A 125V AC 1.5A 250V AC
Contact resistance	50mΩ Max
Insulation resistance	DC 500V 100MΩ Min
Dielectric strength	AC 1500V 1 minute
Cut-out	

FEATURES

- * MATERIAL: Frames are nylon with glass fiber (UL flame: 94V-2). Terminals are silver plated brass.
- * Illuminated actuator are molded in PC, available with red, amber and green colors.
- * Mounted by nut.

R13-508 -

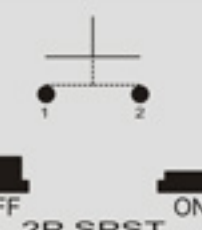
FUNCTION	BUTTON	TERMINAL
A  OFF 2P SPST (ON)	 W/O LED  With LED (3VDC)	 0  5  SO
B  OFF 2P SPST ON		

* () =momentary