

SERIES 1830 - SINGLE AND DOUBLE-POLE ROCKER SWITCHES

TO 20 (4) A 250 V AC





PRODUCT FEATURES

- ◆ 100 million times proven switching principle
- ◆ Mechanical life endurance up to 1 million switching cycles
- ◆ Wide variety
- ◆ Variants with IP 67 or dust protection insert
- ◆ Two housing variants
- ◆ Excellent actuating characteristic
- ◆ Illuminated and non-illuminated variants
- ◆ Approval for 400 V (product-dependent)

ON REQUEST

- ◆ Other colors
- ◆ Other rocker printings
- ◆ Other lamp variants
- ◆ Snap-on customized actuators
- ◆ Cable assembly

Mechanical life endurance	10E4 5E4 (basic type 1839) 1E6 (product-dependent)
Inrush current (capacitive)	120 A / 50 A (contact pair Ag / Cu)
Contact resistance (new condition)	< 100 mOhm (1 A 12 V DC)
Insulation resistance (new condition)	> 100 MOhm (500 V DC)
Voltage strength at 250 V	1 500 V function insulation / basic insulation 3 000 V reinforced insulation 500 V small contact distance
Proof tracking	250 PTI
Insulation spacing	acc. to EN 61058 for reinforced or double insulation
Protection type	IP 40 / IP 67 (product-dependent)
Ambient temperature	connection side -20 °C ... +105 °C / ... +85 °C / ... +100 °C actuating side -20 °C ... +55 °C
Flammability	UL 94 V-2 and UL 94 V-0 (product-dependent)
Heat and fire resistance	850 °C (category D)
Material	actuator PA / PC housing PA connections silver-plated / tinned
Plug force of the terminals	≤ 80 N
Approval marks	  
Suitable for appliances of protection class II	



SERIES 1830 - SINGLE AND DOUBLE-POLE ROCKER SWITCHES

TO 20 (4) A 250 V AC

 single-pole	ON/OFF switch (SPST)							Changeover switch (SPDT momentary)	ON/OFF switch (SPST)						
	1830.3111	1830.3112	1830.3118	1830.3119	1830.8112	1830.0102	1830.6103		1835.3902	1831.0112	1831.0114	1831.0115	1831.3312	1831.3313	1831.3317
Voltage lamp in V	230	230	230	230	230	230	230	230							
Actuator color / printing															
Housing color															
20 (4) A 250 V AC 1E4	•	•	•	•	•					•	•	•	•	•	•
16 (4) A 250 V AC 1E4															
10 (8) A 250 V AC 5E4	•	•	•	•	•					•	•	•	•	•	•
10 (4) A 250 V AC 1E4						•	•								
10 A 12 V DC															
6 (4) A 250 V AC 5E4						•	•								
6 (4) A 250 V AC 1E4															
6 (4) A 250 V AC															
4 (2) A 250 V AC 1E4								•							
30 mA 12 V DC															
16 A 250 V AC 1 HP	•	•	•	•	•					•	•	•	•	•	•
16 A 125 V AC 1 HP															
16 A 250 V AC 1/2 HP										•	•	•	•	•	•
16 A 125 V AC 1/3 HP															
16 A 125 V AC 1/4 HP															
6 A 250 V AC 1/2 HP						•	•								
6 A 125 V AC 1/4 HP															
6 A 125 - 250 V AC 1/8 HP															
6 A 125 V AC 1/10 HP								•							
4 A 250 V AC 1/10 HP								•							
Connection type															
Connection description	6.3	6.3	6.3	6.3	6.3		4.8	6.3				6.3	6.3	6.3	6.3
Contact distance in mm	≥ 3	≥ 3	≥ 3	≥ 3	≥ 3	≥ 3	≥ 3	≥ 3	≥ 3	≥ 3	≥ 3	≥ 3	≥ 3	≥ 3	≥ 3
Contact material	Ag	Ag	Ag	Ag	Ag	Ag	Ag	Ag	Ag	Ag	Ag	Ag	Ag	Ag	Ag
EN 60335 cap. 30 conform "G"				•											•
Miscellaneous					low lying flange		low lying flange	external lamp connection two-pole size							
Stock version	•	•	•	•	•	•			•			•	•		

ROCKER SWITCHES
PUSHBUTTON SWITCHES
TOGGLE SWITCHES
SLIDE SWITCHES
ROTARY SWITCHES
FOOT SWITCHES
POWER TOOL SWITCHES
TACT AND KEY SWITCHES
SNAP-ACTION SWITCHES
MICRO-SIGNAL SWITCHES
SENSORS

SERIES 1830 - SINGLE AND DOUBLE-POLE ROCKER SWITCHES

TO 20 (4) A 250 V AC

 single-pole	ON/OFF switch (SPST)								Normally open contact (SPNO)				Switch (SPDT)	
	1831.3606	1831.3607	1831.3815	1831.3933	1831.8112	1831.1107	1831.7102	1831.8102	1831.1202	1831.3402	1831.8202	1831.1253	1833.3312	1833.1102
Voltage lamp in V														
Actuator color / printing														
Housing color	black	black	black	black	black	black	black	black	black	black	black	black	black	black
20 (4) A 250 V AC 1E4	•	•	•	•	•									
16 (4) A 250 V AC 1E4													•	
10 (8) A 250 V AC 5E4	•	•	•	•	•									
10 (4) A 250 V AC 1E4						•	•	•						•
10 A 12 V DC														
6 (4) A 250 V AC 5E4						•	•	•						•
6 (4) A 250 V AC 1E4														
6 (4) A 250 V AC														
4 (2) A 250 V AC 1E4									•	•	•			
30 mA 12 V DC											•			
16 A 250 V AC 1 HP	•	•	•	•	•									
16 A 125 V AC 1 HP														
16 A 250 V AC 1/2 HP													•	
16 A 125 V AC 1/3 HP	•	•	•	•	•									
16 A 125 V AC 1/4 HP													•	
6 A 250 V AC 1/2 HP						•	•	•						•
6 A 125 V AC 1/4 HP						•	•	•						•
6 A 125 - 250 V AC 1/8 HP														
6 A 125 V AC 1/10 HP									•	•	•			
4 A 250 V AC 1/10 HP									•	•	•			
Connection type														
Connection description	6.3	6.3	6.3	6.3	6.3	4.8	6.3	4.8	6.3	6.3	6.3	4.8	6.3	4.8
Contact distance in mm	≥ 3	≥ 3	≥ 3	≥ 3	≥ 3	≥ 3	≥ 3	≥ 3	≥ 3	≥ 3	≥ 3	≥ 3	≥ 3	≥ 3
Contact material	Ag	Ag	Ag	Ag	Ag	Ag	Ag	Ag	Ag	Ag	Ag	Au	Ag	Ag
EN 60335 cap. 30 conform "G"	•	•												
Miscellaneous	housing with 2 separating gates	housing with 2 separating gates	IP 67 1E6 mechanical life endurance		low lying flange		low lying flange	low lying flange			low lying flange			
Stock version				•	•	•			•	•	•			•

SERIES 1830 - SINGLE AND DOUBLE-POLE ROCKER SWITCHES

TO 20 (4) A 250 V AC

single-pole	Switch (SPDT)			Switch with OFF position in the center (SPDT - Center OFF)											
	1833.3307	1833.7102	1833.8102	1838.0305	1838.3412	1838.3512	1838.3901	1838.1402	1838.1502	1838.1509	1838.1602	1838.4307	1838.7203	1838.8302	1838.3402
Voltage lamp in V															
Actuator color / printing															
Housing color	Black	Black	Black	Black	Black	Black	Black	Black	Black	Black	Black	Black	Black	Black	Black
20 (4) A 250 V AC 1E4															
16 (4) A 250 V AC 1E4				●	●	●	●								
10 (8) A 250 V AC 5E4															
10 (4) A 250 V AC 1E4	●	●	●												
10 A 12 V DC															
6 (4) A 250 V AC 5E4	●	●	●												
6 (4) A 250 V AC 1E4								●	●	●	●	●	●	●	●
6 (4) A 250 V AC															●
4 (2) A 250 V AC 1E4															
30 mA 12 V DC															
16 A 250 V AC 1 HP															
16 A 125 V AC 1 HP															
16 A 250 V AC 1/2 HP				●	●	●	●								
16 A 125 V AC 1/3 HP				●	●	●	●								
16 A 125 V AC 1/4 HP															
6 A 250 V AC 1/2 HP	●	●	●												
6 A 125 V AC 1/4 HP	●	●	●												
6 A 125 - 250 V AC 1/8 HP								●	●	●	●	●	●	●	●
6 A 125 V AC 1/10 HP															
4 A 250 V AC 1/10 HP															
Connection type															
Connection description	6.3	6.3	6.3		6.3	6.3	6.3	4.8	4.8	4.8	4.8	2.8	6.3	6.3	6.3
Contact distance in mm	≥ 3	≥ 3	≥ 3	≥ 3	≥ 3	≥ 3	≥ 3	≥ 3	≥ 3	≥ 3	≥ 3	≥ 3	≥ 3	≥ 3	≥ 3
Contact material	Ag	Ag	Ag	Ag	Ag	Ag	Ag	Ag	Ag	Ag	Ag	Ag	Ag	Ag	Ag
EN 60335 cap. 30 conform "G"	●														
Miscellaneous		low lying flange	low lying flange	momentary function both sides	momentary function both sides		IP 67 1E6 mechanical life endurance	momentary function both sides			momentary function one side	momentary function one side	momentary function one side low lying flange	momentary function both sides low lying flange	momentary function both sides
Stock version	●		●			●	●	●	●		●			●	●

ROCKER SWITCHES

PUSHBUTTON SWITCHES

TOGGLE SWITCHES

SLIDE SWITCHES

ROTARY SWITCHES

FOOT SWITCHES

POWER TOOL SWITCHES

TACT AND KEY SWITCHES

SNAP-ACTION SWITCHES

MICRO-SIGNAL SWITCHES

SENSORS

SERIES 1830 - SINGLE AND DOUBLE-POLE ROCKER SWITCHES

TO 20 (4) A 250 V AC

single-pole	Switch with OFF position in the center (SPDT - Center OFF)		Changeover switch (SPDT momentary)		
	1838.3502		1833.1202	1833.3402	1833.6206
					
Voltage lamp in V					
Actuator color / printing	●		●	●	●
Housing color	■		■	■	■
20 (4) A 250 V AC 1E4					
16 (4) A 250 V AC 1E4					
10 (8) A 250 V AC 5E4					
10 (4) A 250 V AC 1E4					
10 A 12 V DC					
6 (4) A 250 V AC 5E4					
6 (4) A 250 V AC 1E4					
6 (4) A 250 V AC	●				
4 (2) A 250 V AC 1E4			●	●	●
30 mA 12 V DC					
16 A 250 V AC 1 HP					
16 A 125 V AC 1 HP					
16 A 250 V AC 1/2 HP					
16 A 125 V AC 1/3 HP					
16 A 125 V AC 1/4 HP					
6 A 250 V AC 1/2 HP					
6 A 125 V AC 1/4 HP					
6 A 125 - 250 V AC 1/8 HP	●				
6 A 125 V AC 1/10 HP			●	●	●
4 A 250 V AC 1/10 HP			●	●	●
Connection type	⏏		⏏	⏏	⏏
Connection description	6.3		4.8	6.3	4.8
Contact distance in mm	≥ 3		≥ 3	≥ 3	≥ 3
Contact material	Ag		Ag	Ag	Ag
EN 60335 cap. 30 conform "G"					
Miscellaneous					low lying flange
Stock version	●			●	

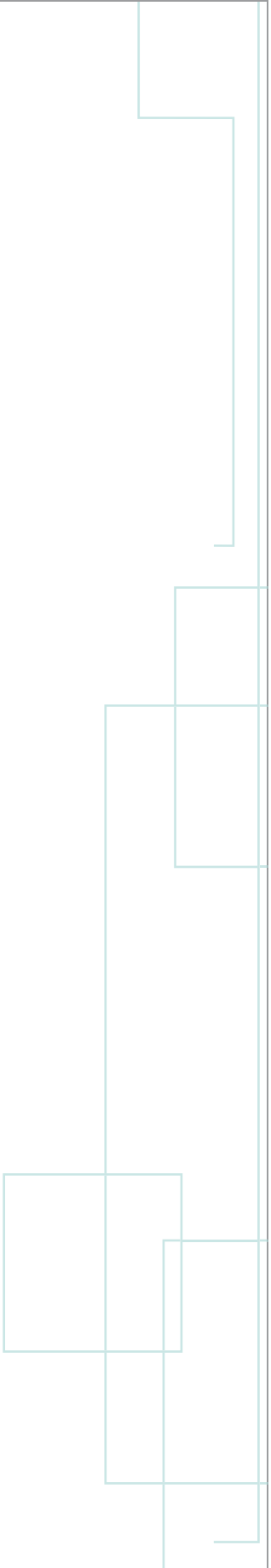

ROCKER SWITCHES
PUSHBUTTON SWITCHES
TOGGLE SWITCHES
SLIDE SWITCHES
ROTARY SWITCHES
FOOT SWITCHES
POWER TOOL SWITCHES
TACT AND KEY SWITCHES
SNAP-ACTION SWITCHES
MICRO-SIGNAL SWITCHES
SENSORS

SERIES 1830 - SINGLE AND DOUBLE-POLE ROCKER SWITCHES

TO 20 (4) A 250 V AC

		ON/OFF switch (DPST)								Switch (DPDT)		ON/OFF switch (DPST)				
		1835.3419	1835.3111	1835.3112	1835.3114	1835.3118	1835.3418	1835.9413	1835.1115	1835.7108		1835.3802	1835.3116	1835.3107	1832.1612	1832.3311
Voltage lamp in V		400	230	230	230	230	230	230	230	230		230	115 -230	12		
Actuator color / printing																
Housing color																
20 (4) A 250 V AC 1E4		•	•	•	•	•	•	•					•		•	•
16 (4) A 250 V AC 1E4																
10 (8) A 250 V AC 5E4		•	•	•	•	•	•	•					•		•	•
10 (4) A 250 V AC 1E4									•	•		•				
10 A 12 V DC														•		
6 (4) A 250 V AC 5E4									•	•		•				
6 (4) A 250 V AC 1E4																
6 (4) A 250 V AC																
4 (2) A 250 V AC 1E4																
30 mA 12 V DC																
16 A 250 V AC 1 HP		•	•	•	•	•	•	•					•		•	•
16 A 125 V AC 1 HP																
16 A 250 V AC 1/2 HP																
16 A 125 V AC 1/3 HP															•	•
16 A 125 V AC 1/4 HP																
6 A 250 V AC 1/2 HP									•	•		•				
6 A 125 V AC 1/4 HP																
6 A 125 - 250 V AC 1/8 HP																
6 A 125 V AC 1/10 HP																
4 A 250 V AC 1/10 HP																
Connection type																
Connection description		6.3	6.3	6.3	6.3	6.3	6.3	4.8	4.8	4.8		6.3	6.3	6.3	4.8	6.3
Contact distance in mm		≥ 3	≥ 3	≥ 3	≥ 3	≥ 3	≥ 3	≥ 3	≥ 3	≥ 3		≥ 3	≥ 3	≥ 3	≥ 3	≥ 3
Contact material		Ag	Ag	Ag	Ag	Ag	Ag	Ag	Ag	Ag		Ag	Ag	Ag	Ag	Ag
EN 60335 cap. 30 conform "G"																
Miscellaneous		10 (8) 400 V AC 5E4 cover frame 33.2 long					cover frame 33.2 long	PCB holder 248.103.011 low lying flange		low lying flange					cover frame 33.2 long	
Stock version			•	•	•	•		•					•			•

ROCKER SWITCHES
PUSHBUTTON SWITCHES
TOGGLE SWITCHES
SLIDE SWITCHES
ROTARY SWITCHES
FOOT SWITCHES
POWER TOOL SWITCHES
TACT AND KEY SWITCHES
SNAP-ACTION SWITCHES
MICRO-SIGNAL SWITCHES
SENSORS

SERIES 1830 - SINGLE AND DOUBLE-POLE ROCKER SWITCHES

TO 20 (4) A 250 V AC

		ON/OFF switch (DPST)										Normally open contact (DPNO)		Switch (DPDT)	
		1832.3312	1832.3313	1832.3508	1832.3602	1832.6112	1832.7103	1832.8112	1832.9103	1832.0113	1832.1102	1832.9101	1832.3407	1832.8204	1834.3311
Voltage lamp in V															
Actuator color / printing		⊖	⊖	⊖	⊖	⊖	⊖	⊖	⊖	⊖	⊖	⊖	⊖	⊖	⊖
Housing color		■	■	■	■	■	■	■	■	■	■	■	■	■	■
20 (4) A 250 V AC 1E4		●	●	●	●	●	●	●	●						
16 (4) A 250 V AC 1E4										●					●
10 (8) A 250 V AC 5E4		●	●	●	●	●	●	●							
10 (4) A 250 V AC 1E4											●	●			
10 A 12 V DC															
6 (4) A 250 V AC 5E4											●	●			
6 (4) A 250 V AC 1E4															
6 (4) A 250 V AC															
4 (2) A 250 V AC 1E4													●	●	
30 mA 12 V DC															
16 A 250 V AC 1 HP		●	●	●	●	●	●	●							
16 A 125 V AC 1 HP									●						
16 A 250 V AC 1/2 HP										●					●
16 A 125 V AC 1/3 HP		●	●	●	●	●	●	●							●
16 A 125 V AC 1/4 HP										●					●
6 A 250 V AC 1/2 HP											●	●			
6 A 125 V AC 1/4 HP											●	●			
6 A 125 - 250 V AC 1/8 HP															
6 A 125 V AC 1/10 HP													●	●	
4 A 250 V AC 1/10 HP													●	●	
Connection type		⊖	⊖	⊖	⊖	⊖	⊖	⊖	⊖	⊖	⊖	⊖	⊖	⊖	⊖
Connection description		6.3	6.3	6.3	6.3	4.8	6.3	6.3	6.3	6.3	4.8	6.3	6.3	6.3	6.3
Contact distance in mm		≥ 3	≥ 3	≥ 3	≥ 3	≥ 3	≥ 3	≥ 3	≥ 3	≥ 3	≥ 3	≥ 3	≥ 3	≥ 3	≥ 3
Contact material		Ag	Ag	Ag	Ag	Ag	Ag	Ag	Ag	Ag	Ag	Ag	Ag	Ag	Ag
EN 60335 cap. 30 conform "G"			●												
Miscellaneous				single-pole occupied	cover frame 33.2 long	low lying flange	low lying flange	low lying flange	low lying flange	dust protection inlay	low lying flange		low lying flange		
Stock version		●			●			●			●		●		

SERIES 1830 - SINGLE AND DOUBLE-POLE ROCKER SWITCHES

TO 20 (4) A 250 V AC

		Switch (DPDT)	1834.3312	1834.1102	1834.1103	1834.3309	1834.3603	1834.6103	1839.1402	1839.1407	1839.1410	1839.1502	1839.1509	1839.1518	1839.1602	1839.2203	1839.3502	1839.3503
Voltage lamp in V																		
Actuator color / printing																		
Housing color																		
20 (4) A 250 V AC 1E4																		
16 (4) A 250 V AC 1E4			●															
10 (8) A 250 V AC 5E4																		
10 (4) A 250 V AC 1E4				●	●	●	●	●										
10 A 12 V DC																		
6 (4) A 250 V AC 5E4				●	●	●	●	●										
6 (4) A 250 V AC 1E4									●	●	●	●	●	●	●	●	●	●
6 (4) A 250 V AC																		
4 (2) A 250 V AC 1E4																		
30 mA 12 V DC																		
16 A 250 V AC 1 HP																		
16 A 125 V AC 1 HP																		
16 A 250 V AC 1/2 HP			●															
16 A 125 V AC 1/3 HP																		
16 A 125 V AC 1/4 HP			●															
6 A 250 V AC 1/2 HP				●	●	●	●	●										
6 A 125 V AC 1/4 HP				●	●	●	●	●										
6 A 125 - 250 V AC 1/8 HP									●	●	●	●	●	●	●	●	●	●
6 A 125 V AC 1/10 HP																		
4 A 250 V AC 1/10 HP																		
Connection type																		
Connection description			6.3	4.8	4.8	6.3	6.3	4.8	4.8	4.8	4.8	4.8	4.8	4.8	4.8	4.8	6.3	6.3
Contact distance in mm			≥ 3	≥ 3	≥ 3	≥ 3	≥ 3	≥ 3	≥ 3	≥ 3	≥ 3	≥ 3	≥ 3	≥ 3	≥ 3	≥ 3	≥ 3	≥ 3
Contact material			Ag	Ag	Ag	Ag	Ag	Ag	Ag	Ag	Ag	Ag	Ag	Ag	Ag	Ag	Ag	Ag
EN 60335 cap. 30 conform "G"							●											
Miscellaneous							cover frame 33.2 long	low lying flange	momentary function both sides	momentary function both sides	momentary function both sides dust protection inlay		dust protection inlay	momentary function one side	momentary function one side			
Stock version			●	●		●			●	●		●	●				●	

ROCKER SWITCHES
PUSHBUTTON SWITCHES
TOGGLE SWITCHES
SLIDE SWITCHES
ROTARY SWITCHES
FOOT SWITCHES
POWER TOOL SWITCHES
TACT AND KEY SWITCHES
SNAP-ACTION SWITCHES
MICRO-SIGNAL SWITCHES
SENSORS

















SERIES 1830 - SINGLE AND DOUBLE-POLE ROCKER SWITCHES

TO 20 (4) A 250 V AC

		Switch (DPDT)	1839.3602	1839.7304	1839.3352	1839.0105	1839.3412	1839.3512	1834.3402	1834.3504
Voltage lamp in V										
Actuator color / printing										
Housing color										
20 (4) A 250 V AC 1E4										
16 (4) A 250 V AC 1E4							●	●		
10 (8) A 250 V AC 5E4										
10 (4) A 250 V AC 1E4										
10 A 12 V DC										
6 (4) A 250 V AC 5E4										
6 (4) A 250 V AC 1E4			●	●						
6 (4) A 250 V AC										
4 (2) A 250 V AC 1E4									●	●
30 mA 12 V DC					●					
16 A 250 V AC 1 HP										
16 A 125 V AC 1 HP										
16 A 250 V AC 1/2 HP							●	●		
16 A 125 V AC 1/3 HP							●	●		
16 A 125 V AC 1/4 HP										
6 A 250 V AC 1/2 HP										
6 A 125 V AC 1/4 HP										
6 A 125 - 250 V AC 1/8 HP			●	●						
6 A 125 V AC 1/10 HP									●	●
4 A 250 V AC 1/10 HP									●	●
Connection type										
Connection description			6.3	6.3	6.3	6.3	6.3	6.3	6.3	6.3
Contact distance in mm			≥ 3	≥ 3	≥ 3	≥ 3	≥ 3	≥ 3	≥ 3	≥ 3
Contact material			Ag	Ag	Au	Ag	Ag	Ag	Ag	Ag
EN 60335 cap. 30 conform "G"										
Miscellaneous			momentary function one side	momentary function one side dust protection inlay, low lying flange	cover frame 33.2 long	dust protection inlay	momentary function both sides			single-pole occupied
Stock version			●				●	●	●	

SERIES 1830 - SINGLE AND DOUBLE-POLE ROCKER SWITCHES

TO 20 (4) A 250 V AC

Lamp	Lamp				
	1837.1118	1837.2504	1837.3102	1837.8102	1837.8108
					
Voltage lamp in V	230	230	230	230	230
Actuator color / printing					
Housing color					
20 (4) A 250 V AC 1E4					
16 (4) A 250 V AC 1E4					
10 (8) A 250 V AC 5E4					
10 (4) A 250 V AC 1E4					
10 A 12 V DC					
6 (4) A 250 V AC 5E4					
6 (4) A 250 V AC 1E4					
6 (4) A 250 V AC					
4 (2) A 250 V AC 1E4					
30 mA 12 V DC					
16 A 250 V AC 1 HP					
16 A 125 V AC 1 HP					
16 A 250 V AC 1/2 HP					
16 A 125 V AC 1/3 HP					
16 A 125 V AC 1/4 HP					
6 A 250 V AC 1/2 HP					
6 A 125 V AC 1/4 HP					
6 A 125 - 250 V AC 1/8 HP					
6 A 125 V AC 1/10 HP					
4 A 250 V AC 1/10 HP					
Connection type					
Connection description	4.8		6.3	6.3	6.3
Contact distance in mm					
Contact material					
EN 60335 cap. 30 conform "G"					
Miscellaneous		low lying flange		size basic type 1835	size basic type 1835
Stock version	●		●	●	●

ROCKER SWITCHES

PUSHBUTTON SWITCHES

TOGGLE SWITCHES

SLIDE SWITCHES

ROTARY SWITCHES

FOOT SWITCHES

POWER TOOL SWITCHES

TACT AND KEY SWITCHES

SNAP-ACTION SWITCHES

MICRO-SIGNAL SWITCHES

SENSORS

SERIES 1830 - SINGLE AND DOUBLE-POLE ROCKER SWITCHES

TO 20 (4) A 250 V AC



Basic types 1830, 1831, 1833 and 1838
single-pole
illuminated / non-illuminated

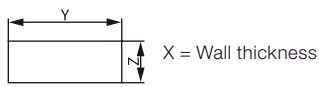

X	Y	Z
0.75 ... 1.25	30 ^{-0.1}	11 ^{+0.1}
1.25 ... 2	30.2 ^{-0.1}	11 ^{+0.1}
2 ... 3	30.6 ^{-0.1}	11 ^{+0.1}

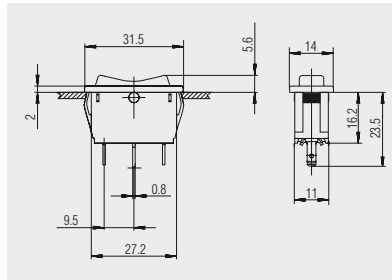

Quick-connect terminal 2.8
1838.4307

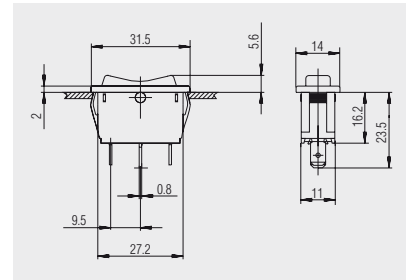

Quick-connect terminal 4.8
basic type 1838

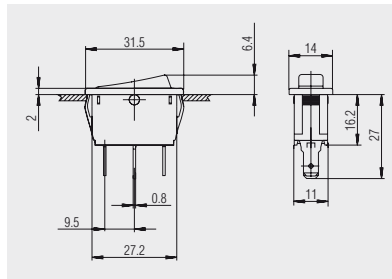

Quick-connect terminal 4.8
basic types 1830, 1831 and 1833

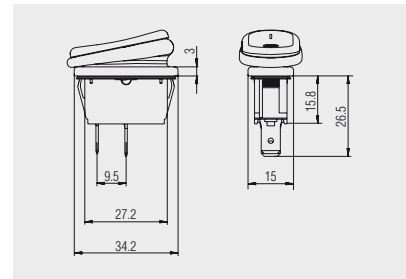

Quick-connect terminal 6.3
1831.3815

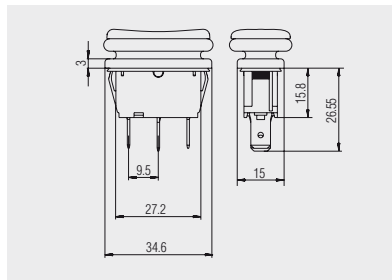

Quick-connect terminal 6.3
1838.3901

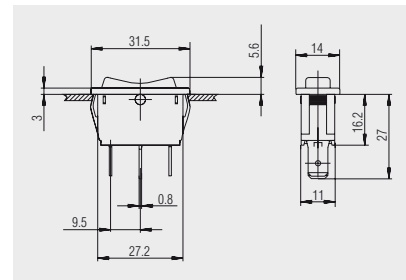

Quick-connect terminal 6.3
basic type 1838

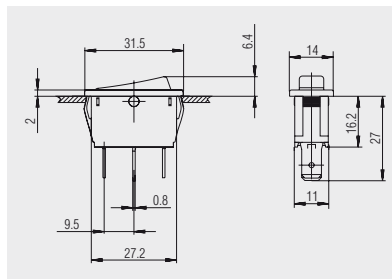

Quick-connect terminal 6.3
basic types 1831 and 1833

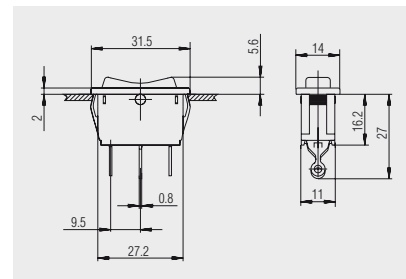

Solder terminal
basic type 1838

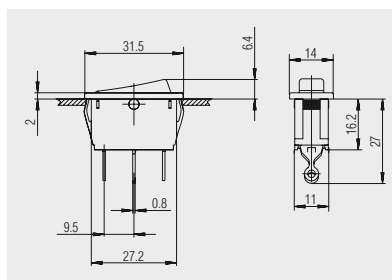

Solder terminal
basic types 1830 and 1831

SERIES 1830 - SINGLE AND DOUBLE-POLE ROCKER SWITCHES

TO 20 (4) A 250 V AC



Basic types 1832, 1834, 1835 and 1839
double-pole
illuminated / non-illuminated

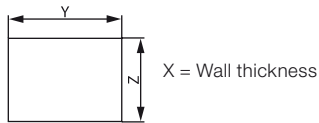

X	Y	Z
0.75 ... 1.25	30 ^{-0.1}	22 ^{+0.2}
1.25 ... 2	30.2 ^{-0.1}	22 ^{+0.2}
2 ... 3	30.6 ^{-0.1}	22 ^{+0.2}

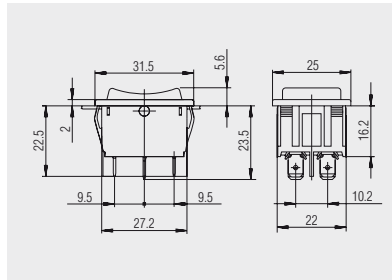

Quick-connect terminal 4.8
basic type 1839

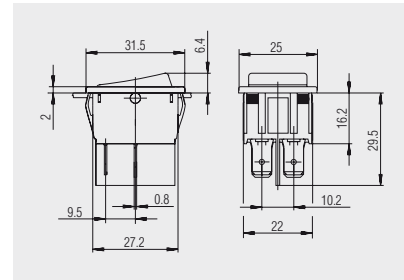

Quick-connect terminal 6.3 / 4.8
basic types 1832, 1834 and 1835

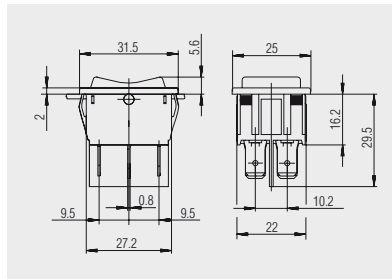

Quick-connect terminal 6.3
basic type 1839

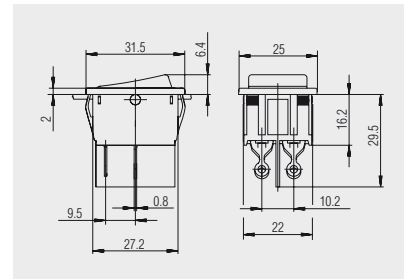

Solder terminal
basic type 1832

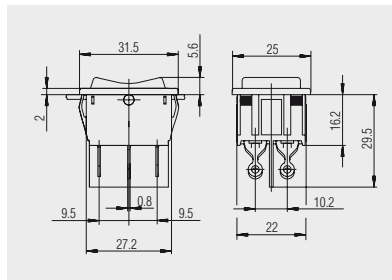

Solder terminal
basic type 1839

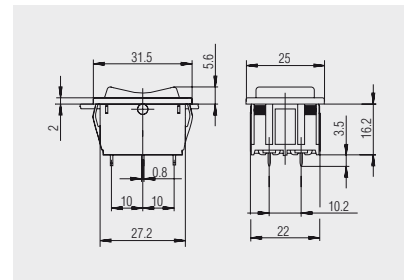

PCB terminal
basic type 1839



Basic types 1830, 1831, 1833 and 1838
single-pole, lower lying flange
illuminated / non-illuminated

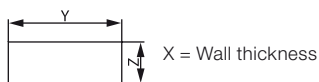

X	Y	Z
0.75 ... 1.25	30 ^{-0.1}	11 ^{+0.1}
1.25 ... 2	30.2 ^{-0.1}	11 ^{+0.1}
2 ... 3	30.6 ^{-0.1}	11 ^{+0.1}

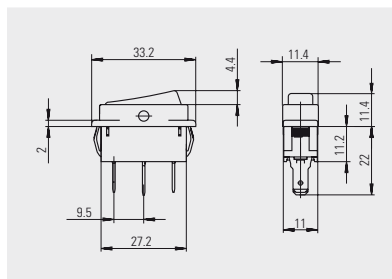

Quick-connect terminal 4.8
basic types 1830, 1831 and 1833

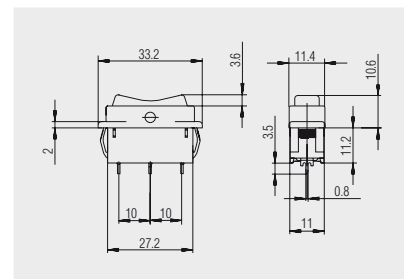

PCB terminal
basic type 1838

ROCKER SWITCHES

PUSHBUTTON SWITCHES

TOGGLE SWITCHES

SLIDE SWITCHES

ROTARY SWITCHES

FOOT SWITCHES

POWER TOOL SWITCHES

TACT AND KEY SWITCHES

SNAP-ACTION SWITCHES

MICRO-SIGNAL SWITCHES

SENSORS

SERIES 1830 - SINGLE AND DOUBLE-POLE ROCKER SWITCHES

TO 20 (4) A 250 V AC



Basic types 1832, 1834, 1835 and 1839
double-pole, lower lying flange illuminated / non-illuminated

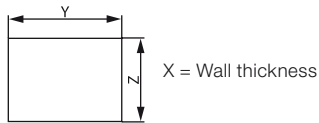

X	Y	Z
0.75 ... 1.25	30 ^{-0.1}	22 ^{+0.2}
1.25 ... 2	30.2 ^{-0.1}	22 ^{+0.2}
2 ... 3	30.6 ^{-0.1}	22 ^{+0.2}

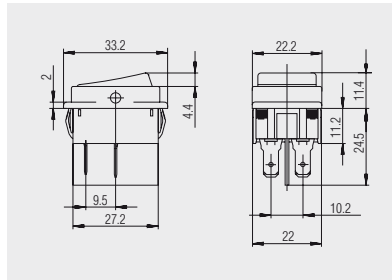

Quick-connect terminal 4.8
basic types 1832 and 1834

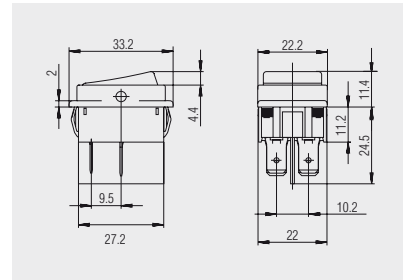

Quick-connect terminal 6.3
basic type 1832

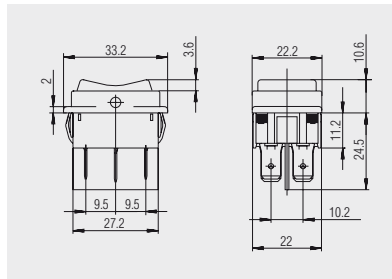

Quick-connect terminal 6.3
basic type 1839

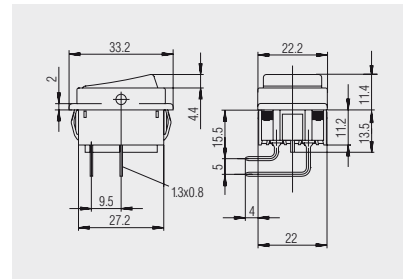

PCB terminal angled
basic types 1832 and 1835

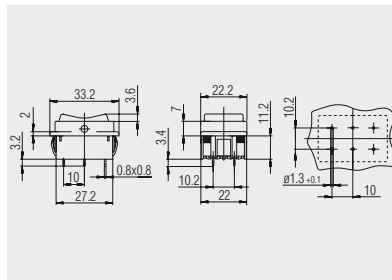

PCB terminal
basic type 1839

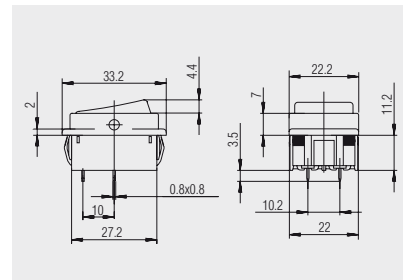

PCB terminal
basic types 1832 and 1835



Basic type 1837
Lamp
single and double-pole

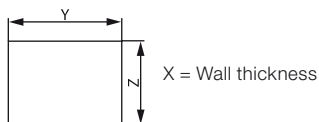

X	Y	Z
0.75 ... 1.25	30 ^{-0.1}	22 ^{+0.1}
1.25 ... 2	30.2 ^{-0.1}	22 ^{+0.1}
2 ... 3	30.6 ^{-0.1}	22 ^{+0.1}

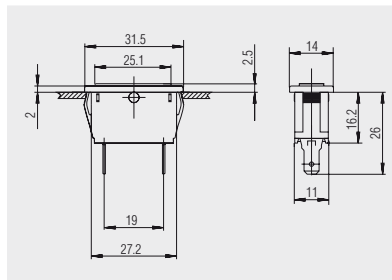

Quick-connect terminal 4.8
single-pole size

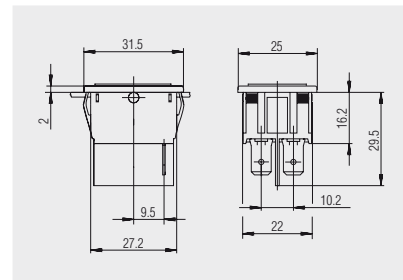

Quick-connect terminal 6.3
double-pole size

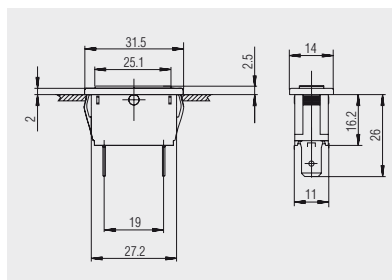

Quick-connect terminal 6.3
single-pole size

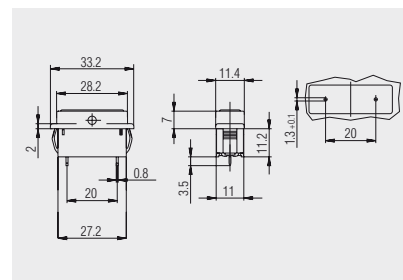

PCB terminal, lower lying flange, 1837.2504

SERIES 1830 - SINGLE AND DOUBLE-POLE ROCKER SWITCHES

TO 20 (4) A 250 V AC



Protection cap
203.731.011

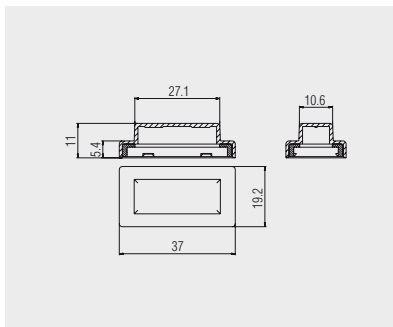

Transparent PVC-protection cap for single-pole switches of basic types 1830, 1831, 1833 and 1838. Serves as dust and water protection of the actuation side.



Protection cap
203.201.011

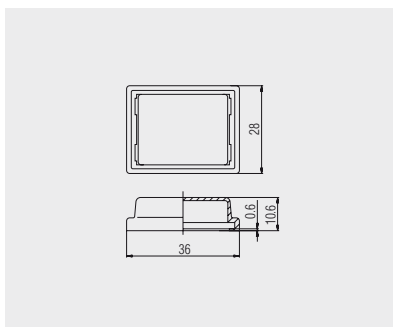

Transparent PVC-protection cap for double-pole switches of basic types 1832, 1834, 1835 and 1839 with frame length 33.2 mm. Serves as dust and water protection of the actuation side.



Dummy cap
203.146.051

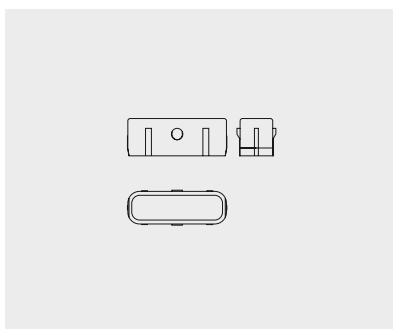

Dummy cap for single-pole size of basic types 1830, 1831, 1833, 1837 and 1838 of PA black



Dummy cap
203.145.051

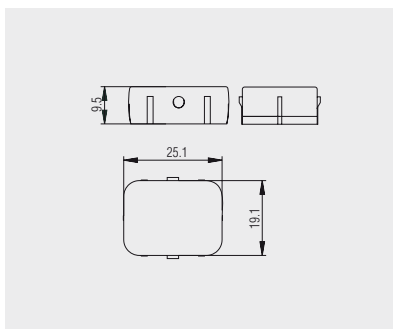

Dummy cap for double-pole size of basic types 1832, 1834, 1835, 1837 and 1839 of PA black

ROCKER SWITCHES

PUSHBUTTON SWITCHES

TOGGLE SWITCHES

SLIDE SWITCHES

ROTARY SWITCHES

FOOT SWITCHES

POWER TOOL SWITCHES

TACT AND KEY SWITCHES

SNAP-ACTION SWITCHES

MICRO-SIGNAL SWITCHES

SENSORS