



Serie 581

Miniatur Rundsteckverbinder Serie 581 Miniature circular connectors series 581

Kurzinformation Brief information

Kabelsteckverbinder

- Steckverbinder mit Schraubverriegelung nach IEC 130-9
- Schutzart IP 40 ¹⁾
- Gute EMV Eigenschaften
- Ausführungen mit Kabeltülle (guter Knickschutz)
- Innenliegende Zugentlastung
- Versionen mit Klemmkorb und Lötöse oder mit Kabelklemme
- Winkelausführungen siehe Serie 682

Cable Connector

- Connector with screw locking according to IEC 130-9
- Degree of protection IP 40 ¹⁾
- Good EMI characteristics
- Construction with cable bushing (good antikink)
- Internal strain relief
- Versions with pinch ring and solder eye ring or with cable clamp
- Angled versions see series 682

Aufbau des Steckverbinders:
Construction of the connector:

Ausführung mit Kabelklemme
Construction with cable clamp

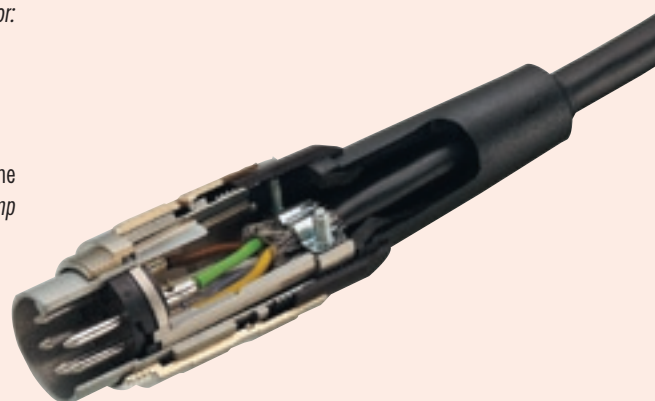

Ausführung mit Lötöse
Construction with solder eye

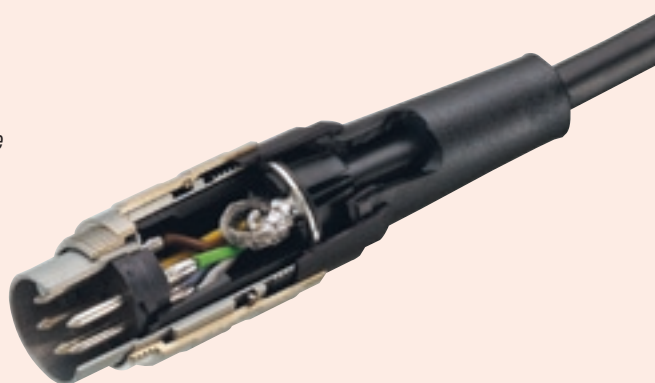

Flanschsteckverbinder

- 1 Standard: mit Lötanschluss, wird von vorn eingesetzt und von hinten verschraubt.
- 2 Mit Lötanschluss, von vorn verschraubbar, besonders geeignet für vorkonfektionierte Kabelbäume, die nach dem Lötén eingebaut werden.
- 3 Mit Tauchlötanschluss, für den Anschluss auf die Leiterplatte (Abbildung vor dem Einbau in das Gehäuse).
- 4 Mit Tauchlötanschluss nach der Gehäusemontage.

Chassis sockets

- 1 Standard, with solder termination, mounted from front side and fastened from back side.
- 2 With solder termination, mounted from back side and fastened from front side, especially suited for preassembled cable trees which are mounted after soldering.
- 3 Dip solder termination for connection to PCB (figure: before built in into housing).
- 4 Dip solder termination after installation into housing.

1



2



3

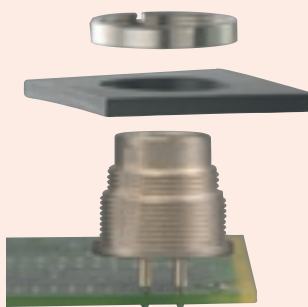

4

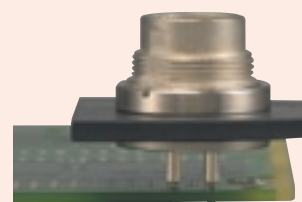

¹⁾ Erläuterung der Schutzarten siehe Seite TI-3 – TI-4. / ¹⁾ Explanation of protection standards see page TI-3 – TI-4.

Miniatur Rundsteckverbinder Serie 581 Miniature circular connectors series 581		Technische Daten ¹⁾ Specifications ¹⁾													
Allgemeine Kennwerte		General Characteristics													
Polzahl	Number of contacts	2	3 DIN	4	5	5 DIN	6 DIN	7	7 DIN	8 DIN	12	14	16	19	24
Verriegelung	Locking system	schrauben / screw													
Anschlussart	Termination	löten, tauchlöten / solder, dip solder													
Anschlussquerschnitt in mm ²	Wire gauge in mm ²	max. 0,75						max. 0,25				0,14			
Anschlussquerschnitt in AWG	Wire gauge in AWG	max. 20						max. 24				26			
Kabeldurchlass	Cable outlet	4 - 6 mm (.16 - .24) / 6 - 8 mm (.24 - .32)													
Schutzart Gehäuse	Shell protection	IP 40													
Mechanische Lebensdauer	Mechanical operation	> 500 Steckzyklen / > 500 mating cycles													
Obere Grenztemperatur	Upper temperature	+ 85 °C (+ 185 °F)													
Untere Grenztemperatur	Lower temperature	- 40 °C (- 40 °F)													
Gewicht Kabelsteckverbinder	Weight cable connector	~ 25 g													
Gewicht Flanschsteckverbinder	Weight socket	~ 12 g													
Elektrische Kennwerte		Electrical Characteristics													
Bemessungsspannung	Rated voltage	250 V (32 V)		60 V (32V)	250 V (32V)	125 V (32V)	60 V (32 V)								
Bemessungs-Stoßspannung	Rated impulse voltage	1500 V		500 V	1500 V	800 V	500 V								
Verschmutzungsgrad	Pollution degree	1 (2) ²⁾													
Überspannungskategorie	Overvoltage categorie	I (II) ²⁾													
Isolierstoffgruppe	Material group	III													
Prüfstoßspannung	Test voltage	1750 V		550 V	1750 V	910 V	550 V								
Bemessungsstrom (40 °C)	Rated current (40 °C)	7 A	6 A		5 A			3 A		1 A					
Durchgangswiderstand	Contact resistance	≤ 5 mΩ						≤ 3 mΩ							
Isolationswiderstand	Insulation resistance	≥ 10 ¹⁰ Ω													
Werkstoffe		Materials													
Kontaktstift	Pin contact	CuZn (Messing/brass)													
Kontaktbuchse	Socket contact	CuSn (Bronze/bronze)													
Kontaktoberfläche	Contact plating	Ag (Silber/silver) / Au (Gold/gold)						Au (Gold/gold)							
Steckerkörper	Male insert	PBT (UL 94 V-0)													
Buchsenkörper	Female Insert	PBT (UL 94 V-0)													
Gehäuse Kabelstecker	Housing cable connector	CuZn (Messing/brass)													
Gewinding	Ring nut	Messing, vernickelt/brass, nickel plated													
Flanschgehäuse	Socket	Zink-Druckguss, vernickelt/zinc diecasting, nickel plated													







¹⁾ Normen und Prüfbedingungen für diese Angaben siehe Seite TI-16 / Standards and test parameters for this data see page TI-16.

²⁾ Bei Verschmutzungsgrad 2, Überspannungskategorie II reduzierte Bemessungsspannung 32 V. / In case of pollution degree 2, overvoltage categorie II rated voltage is reduced to 32 V.

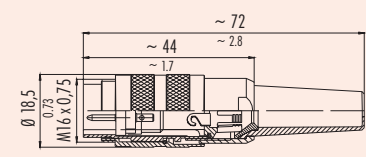
Ü
TI

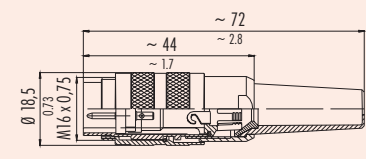
Miniatur Rundsteckverbinder Serie 581 Miniature circular connectors series 581

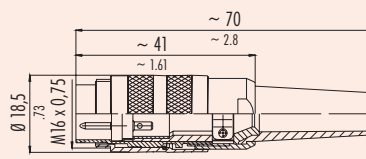

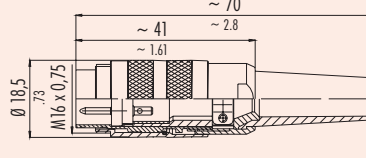



Kabelstecker Male cable connectors

Bezeichnung — Abbildung Description — Figure	Maßzeichnung Drawing	Polzahl Contacts	Bestell-Nr./Ordering-No.	
			versilberte Kontakte silver plated contacts	vergoldete Kontakte gold plated contacts
Kabelstecker mit Lötöse Kabeldurchlass 4 - 6 mm <i>Male cable connector with solder eye cable outlet 4 - 6 mm (.16 - .24 in.)</i> 		2	99-2001-00-02	99-2001-09-02
		3 DIN	99-2005-00-03	99-2005-09-03
		4	99-2009-00-04	99-2009-09-04
		5	99-2013-00-05	99-2013-09-05
		5 (Stereo)	99-2017-00-05	99-2017-09-05
		6 DIN	99-2021-00-06	99-2021-09-06
		7	99-2025-00-07	99-2025-09-07
		7 DIN	99-2581-00-07	— ¹⁾
		8 DIN	99-2061-00-08	99-2061-09-08
		12	—	99-2029-00-12
		14	—	99-2033-00-14
		16	—	99-2037-00-16
		19	—	99-2041-00-19
24	—	—		
Kabelstecker mit Lötöse Kabeldurchlass 6 - 8 mm <i>Male cable connector with solder eye cable outlet 6 - 8 mm (.24 - .32 in.)</i> 		2	99-2001-02-02	99-2001-92-02
		3 DIN	99-2005-02-03	99-2005-92-03
		4	99-2009-02-04	99-2009-92-04
		5	99-2013-02-05	99-2013-92-05
		5 (Stereo)	99-2017-02-05	99-2017-92-05
		6 DIN	99-2021-02-06	99-2021-92-06
		7	99-2025-02-07	99-2025-92-07
		7 DIN	— ¹⁾	— ¹⁾
		8 DIN	99-2061-02-08	99-2061-92-08
		12	—	99-2029-02-12
		14	—	99-2033-02-14
		16	—	99-2037-02-16
		19	—	99-2041-02-19
24	—	99-2045-02-24		
Kabelstecker mit Kabelklemme Kabeldurchlass 4 - 6 mm <i>Male cable connector with cable clamp cable outlet 4 - 6 mm (.16 - .24 in.)</i> 		2	99-2001-10-02	99-2001-19-02
		3 DIN	99-2005-10-03	— ¹⁾
		4	99-2009-10-04	— ¹⁾
		5	99-2013-10-05	99-2013-19-05
		5 (Stereo)	99-2017-10-05	— ¹⁾
		6 DIN	99-2021-10-06	— ¹⁾
		7	99-2025-10-07	99-2025-19-07
		7 DIN	— ¹⁾	— ¹⁾
		8 DIN	99-2061-10-08	— ¹⁾
		12	—	99-2029-10-12
		14	—	99-2033-10-14
		16	—	99-2037-10-16
		19	—	99-2041-10-19
24	—	—		
Kabelstecker mit Kabelklemme Kabeldurchlass 6 - 8 mm <i>Male cable connector with cable clamp cable outlet</i> 		2	99-2001-20-02	99-2001-29-02
		3 DIN	99-2005-20-03	99-2005-29-03
		4	99-2009-20-04	99-2009-29-04
		5	99-2013-20-05	99-2013-29-05
		5 (Stereo)	99-2017-20-05	— ¹⁾
		6 DIN	99-2021-20-06	99-2021-29-06
		7	99-2025-20-07	99-2025-29-07
		7 DIN	— ¹⁾	— ¹⁾
		8 DIN	99-2061-20-08	99-2061-29-08
		12	—	99-2029-20-12
		14	—	99-2033-20-14
		16	—	99-2037-20-16
		19	—	99-2041-20-19
24	—	99-2045-20-24		

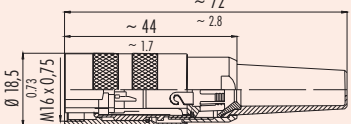
¹⁾ Auf Anfrage / Upon request.

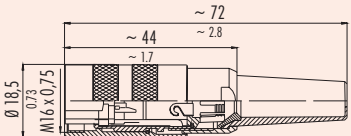
620
702
709
710
711
712
719
423
425
440
581
678
680
682
720
723
623
690
691
692
693
694
707
713
718
733
763
765
768
714
715
766
815
820
825
876
772
775
A
B
C
R

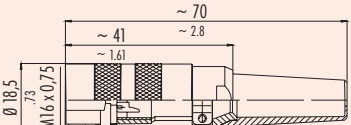
Miniatur Rundsteckverbinder Serie 581 Kabeldosen *Miniature circular connectors series 581* *Female cable connectors*

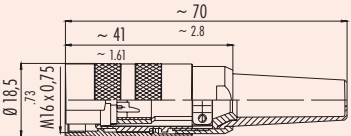
Bezeichnung — Abbildung Description — Figure	Maßzeichnung Drawing	Polzahl Contacts	Bestell-Nr./Ordering-No.	
			versilberte Kontakte silver plated contacts	vergoldete Kontakte gold plated contacts
Kabeldose mit Lötöse Kabeldurchlass 4 - 6 mm <i>Female cable connector with solder eye cable outlet 4 - 6 mm (.16 - .24 in.)</i> 		2	99-2002-00-02	99-2002-09-02
		3 DIN	99-2006-00-03	99-2006-09-03
		4	99-2010-00-04	99-2010-09-04
		5	99-2014-00-05	99-2014-09-05
		5 (Stereo)	99-2018-00-05	99-2018-09-05
		6 DIN	99-2022-00-06	99-2022-09-06
		7	99-2026-00-07	99-2026-09-07
		7 DIN	99-2582-00-07	—
		8 DIN	99-2062-00-08	99-2062-09-08
		12	—	99-2030-00-12
		14	—	99-2034-00-14
		16	—	99-2038-00-16
		19	—	99-2042-00-19
		24	—	—
Kabeldose mit Lötöse Kabeldurchlass 6 - 8 mm <i>Female cable connector with solder eye cable outlet 6 - 8 mm (.24 - .32 in.)</i> 		2	99-2002-02-02	99-2002-92-02
		3 DIN	99-2006-02-03	99-2006-92-03
		4	99-2010-02-04	99-2010-92-04
		5	99-2014-02-05	99-2014-92-05
		5 (Stereo)	99-2018-02-05	99-2018-92-05
		6 DIN	99-2022-02-06	99-2022-92-06
		7	99-2026-02-07	99-2026-92-07
		7 DIN	—	—
		8 DIN	99-2062-02-08	99-2062-92-08
		12	—	99-2030-02-12
		14	—	99-2034-02-14
		16	—	99-2038-02-16
		19	—	99-2042-02-19
		24	—	99-2046-02-24
Kabedose mit Kabelklemme Kabeldurchlass 4 - 6 mm <i>Female cable connector with cable clamp cable outlet 4 - 6 mm (.16 - .24 in.)</i> 		2	99-2002-10-02	99-2002-19-02
		3 DIN	99-2006-10-03	99-2006-19-03
		4	99-2010-10-04	99-2010-19-04
		5	99-2014-10-05	99-2014-19-05
		5 (Stereo)	99-2018-10-05	— ¹⁾
		6 DIN	99-2022-10-06	99-2022-19-06
		7	99-2026-10-07	— ¹⁾
		7 DIN	—	— ¹⁾
		8 DIN	99-2062-10-08	99-2062-19-08
		12	—	99-2030-10-12
		14	—	99-2034-10-14
		16	—	99-2038-10-16
		19	—	99-2042-10-19
		24	—	—
Kabeldose mit Kabelklemme Kabeldurchlass 6 - 8 mm <i>Female cable connector with cable clamp cable outlet 6 - 8 mm (.24 - .32 in.)</i> 		2	99-2002-20-02	99-2002-29-02
		3 DIN	99-2006-20-03	99-2006-29-03
		4	99-2010-20-04	99-2010-29-04
		5	99-2014-20-05	99-2014-29-05
		5 (Stereo)	99-2018-20-05	— ¹⁾
		6 DIN	99-2022-20-06	99-2022-29-06
		7	99-2026-20-07	99-2026-29-07
		7 DIN	—	— ¹⁾
		8 DIN	99-2062-20-08	99-2062-29-08
		12	—	99-2030-20-12
		14	—	99-2034-20-14
		16	—	99-2038-20-16
		19	—	99-2042-20-19
		24	—	99-2046-20-24

¹⁾ Auf Anfrage / Upon request.

Ü
TI

620
702
709
710
711
712
719
423
425
440
581
678
680
682
720
723
623
690
691
692
693
694
707
713
718
733
763
765
768
714
715
766
815
820
825
876
772
775
A
B
C
R

Ü
TI

620
702
709
710
711
712
719
423
425
440
581
678
680
682
720
723
623
690
691
692
693
694
707
713
718
733
763
765
768
714
715
766
815
820
825
876
772
775
A
B
C

R







Miniatur Rundsteckverbinder Serie 581 Miniature circular connectors series 581

Flanschstecker Male sockets

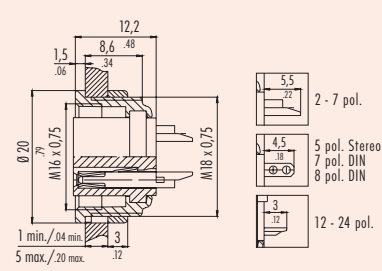
Bezeichnung — Abbildung Description — Figure	Maßzeichnung Drawing	Polzahl Contacts	Bestell-Nr./Ordering-No.	
			versilberte Kontakte silver plated contacts	vergoldete Kontakte gold plated contacts
Flanschstecker, löten Male socket, solder		2	09-0303-00-02	09-0303-09-02
		3 DIN	09-0307-00-03	09-0307-09-03
		4	09-0311-00-04	09-0311-09-04
		5	09-0315-00-05	09-0315-09-05
		5 (Stereo)	09-0319-00-05	09-0319-09-05
		6 DIN	09-0323-00-06	09-0323-09-06
		7	09-0327-00-07	09-0327-09-07
		7 DIN	09-1583-00-07	—
		8 DIN	09-0473-00-08	09-0473-09-08
		12	—	09-0331-00-12
		14	—	09-0053-00-14
		16	—	09-0339-00-16
19	—	09-0335-00-19		
24	—	09-0197-00-24		
Flanschstecker, löten, von vorn verschraubbar Male socket, solder, front fastened		2	09-0303-80-02	09-0303-89-02
		3 DIN	09-0307-80-03	09-0307-89-03
		4	09-0311-80-04	09-0311-89-04
		5	09-0315-80-05	09-0315-89-05
		5 (Stereo)	09-0319-80-05	09-0319-89-05
		6 DIN	09-0323-80-06	09-0323-89-06
		7	09-0327-80-07	09-0327-89-07
		7 DIN	—	—
		8 DIN	09-0473-80-08	09-0473-89-08
		12	—	09-0331-80-12
		14	—	09-0053-80-14
		16	—	09-0339-80-16
19	—	09-0335-80-19		
24	—	09-0197-80-24		
Flanschstecker, tauchlöten, von vorn verschraubbar Male socket, dip solder, front fastened		2	09-0303-90-02	09-0303-99-02
		3 DIN	09-0307-90-03	09-0307-99-03
		4	09-0311-90-04	09-0311-99-04
		5	09-0315-90-05	09-0315-99-05
		5 (Stereo)	09-0319-90-05	09-0319-99-05
		6 DIN	09-0323-90-06	09-0323-99-06
		7	09-0327-90-07	09-0327-99-07
		7 DIN	—	—
		8 DIN	09-0473-90-08	09-0473-99-08
		12	—	09-0331-90-12
		14	—	09-0053-90-14
		16	—	09-0339-90-16
19	—	09-0335-90-19		
24	—	09-0197-90-24		
Flanschstecker mit Flexplatte, von vorn verschraubbar Male socket with flexible PCB, front fastened		7	09-0327-65-07	
		8	09-0473-65-08	
		12		09-0331-65-12
		12		09-0331-66-12

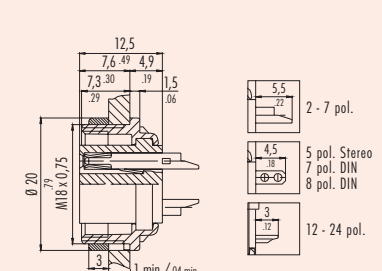
Weitere Maße siehe Seite 581-11
Additional dimensions see page 581-11

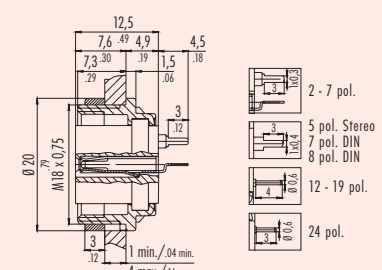
¹⁾ Flanschstecker von Serie 680 / Sockets from series 680.

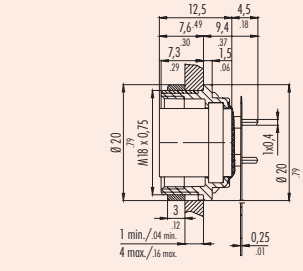
Miniatur Rundsteckverbinder Serie 581 Miniature circular connectors series 581		Flanschdosen Female sockets		
Bezeichnung — Abbildung Description — Figure	Maßzeichnung Drawing	Polzahl Contacts	Bestell-Nr./Ordering-No.	
			versilberte Kontakte silver plated contacts	vergoldete Kontakte gold plated contacts
Flanschdose, löten Female socket, solder 		2	09-0304-00-02	09-0304-09-02
		3 DIN	09-0308-00-03	09-0308-09-03
		4	09-0312-00-04	09-0312-09-04
		5	09-0316-00-05	09-0316-09-05
		5 (Stereo)	09-0320-00-05	09-0320-09-05
		6 DIN	09-0324-00-06	09-0324-09-06
		7	09-0328-00-07	09-0328-09-07
		7 DIN	09-1584-00-07	—
		8 DIN	09-0474-00-08	09-0474-09-08
		12	—	09-0332-00-12
		14	—	09-0054-00-14
		16	—	09-0340-00-16
		19	—	09-0336-00-19
Flanschdose, löten, von vorn verschraubbar Female socket, solder, front fastened 		2	09-0304-80-02	09-0304-89-02
		3 DIN	09-0308-80-03	09-0308-89-03
		4	09-0312-80-04	09-0312-89-04
		5	09-0316-80-05	09-0316-89-05
		5 (Stereo)	09-0320-80-05	09-0320-89-05
		6 DIN	09-0324-80-06	09-0324-89-06
		7	09-0328-80-07	09-0328-89-07
		7 DIN	—	—
		8 DIN	09-0474-80-08	09-0474-89-08
		12	—	09-0332-80-12
		14	—	09-0054-80-14
		16	—	09-0340-80-16
		19	—	09-0336-80-19
Flanschdose, tauchlöten, von vorn verschraubbar Female socket, dip solder, front fastened 		2	09-0304-90-02	09-0304-99-02
		3 DIN	09-0308-90-03	09-0308-99-03
		4	09-0312-90-04	09-0312-99-04
		5	09-0316-90-05	09-0316-99-05
		5 (Stereo)	09-0320-90-05	09-0320-99-05
		6 DIN	09-0324-90-06	09-0324-99-06
		7	09-0328-90-07	09-0328-99-07
		7 DIN	—	—
		8 DIN	09-0474-90-08	09-0474-99-08
		12	—	09-0332-90-12
		14	—	09-0054-90-14
		16	—	09-0340-90-16
		19	—	09-0336-90-19
24	—	09-0198-90-24		
Flanschdose mit Flexplatte, von vorn verschraubbar Female socket with flexible PCB, front fastened 		7	09-0328-65-07	
		8	09-0474-65-08	
		12		09-0332-65-12
		12		09-0332-66-12

Ü
TI

620
702
709
710
711
712
719
423
425
440
581
678
680
682
720
723
623
690
691
692
693
694
707
713
718
733
763
765
768
714
715
766
815
820
825
876
772
775
A
B
C

R

¹⁾ Flanschstecker von Serie 680 / Sockets from series 680.

Ü
TI

Miniatur Rundsteckverbinder Serie 581 Miniature circular connectors series 581

Polbilder Contact arrangements

Polbilder mit Sicht auf die Lötanschlussseite der Stifteinsätze
Contact arrangements with view on the solder termination side of male inserts

x-y Koordinaten
x-y Coordinates

2 pol

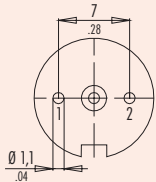

3 pol (DIN 41524)

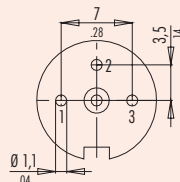

4 pol

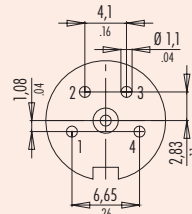

12 pol

	X	Y
A	-0,41	-3,45
B	2,29	-3,61
C	4,10	-1,21
D	3,20	1,34
E	2,71	3,59
F	0,41	3,45
G	-2,29	3,61
H	-4,10	1,21
J	-3,20	-1,34
K	-2,71	-3,59
L	2,00	-1,51
M	-2,00	1,51

5 pol

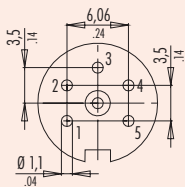

5 pol stereo (DIN 41524)

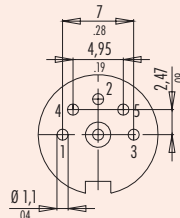

6 pol (DIN 45322)

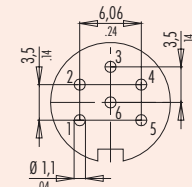

14 pol

	X	Y		X	Y
A	2,50	-4,00	T	-2,40	-0,95
C	4,25	0,00	U	-0,95	-2,40
E	2,30	4,00			
G	-2,30	4,00			
J	-4,25	0,00			
L	-2,50	-4,00			
M	0,95	-2,40			
N	2,40	-0,95			
O	2,40	0,95			
P	0,95	2,40			
R	-0,95	2,40			
S	-2,40	0,95			

7 pol

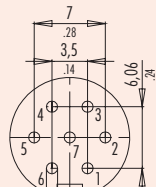

7 pol (DIN 45329)

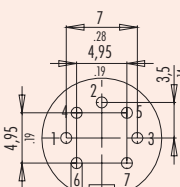

8 pol (DIN 45326)

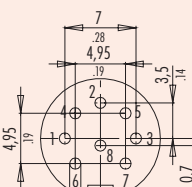

16 pol

	X	Y		X	Y
A	2,50	-4,00	N	2,45	-0,80
B	4,00	-2,25	O	2,40	2,10
C	4,25	0,00	P	-1,50	2,10
D	4,00	2,40	R	-2,45	-0,80
E	2,30	4,00			
F	0,00	4,25			
G	-2,30	4,00			
H	-4,00	2,40			
I	-4,25	0,00			
K	-4,00	-2,25			
L	-2,50	-4,00			
M	0,00	-2,60			

12 pol

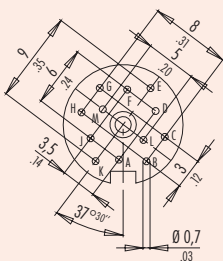

14 pol

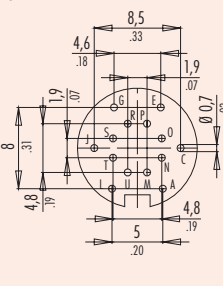

16 pol

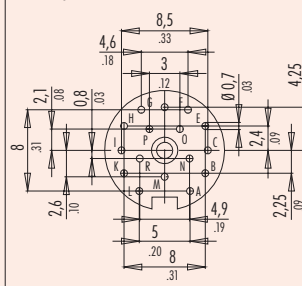

19 pol

	X	Y		X	Y
A	2,50	-4,00	N	2,40	-0,95
B	4,00	-2,25	O	2,40	0,95
C	4,25	0,00	P	0,95	2,40
D	4,00	2,40	R	-0,95	2,40
E	2,30	4,00	S	-2,40	0,95
F	0,00	4,25	T	-2,40	-0,95
G	-2,30	4,00	U	-0,95	-2,40
H	-4,00	2,40			
I	-4,25	0,00			
K	-4,00	-2,25			
L	-2,50	-4,00			
M	0,95	-2,40			

19 pol

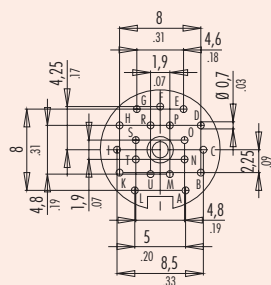

24 pol

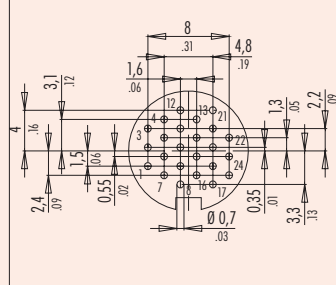

Montageausschnitt
Panel cut out

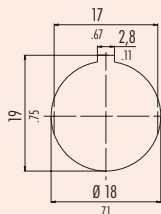

24 pol

	X	Y		X	Y
1	-4,00	-1,50	13	0,80	3,10
2	-4,00	0,35	14	0,80	1,30
3	-4,00	2,20	15	0,80	-0,55
4	-2,40	3,10	16	0,80	-2,40
5	-2,40	1,30	17	2,40	-3,30
6	-2,40	-0,55	18	2,40	-1,50
7	-2,40	2,40	19	2,40	0,35
8	-0,80	-3,30	20	2,40	2,20
9	-0,80	-1,50	21	2,40	4,00
10	-0,80	0,35	22	4,00	1,30
11	-0,80	2,20	23	4,00	-0,55
12	-0,80	4,00	24	4,00	-2,40

¹⁾ Polbilder von Serie 680 / Contact arrangements from series 680.

620
702
709
710
711
712
719
423
425
440
581
678
680
682
720
723
623
690
691
692
693
694
707
713
718
733
763
765
768
714
715
766
815
820
825
876
772
775
A
B
C
R

Miniatur Rundsteckverbinder Serie 581 Miniature circular connectors series 581

Einzelteildarstellung Component part drawings

Kabelsteckverbinder mit Lötösenring
Cable connector with solder eye ring

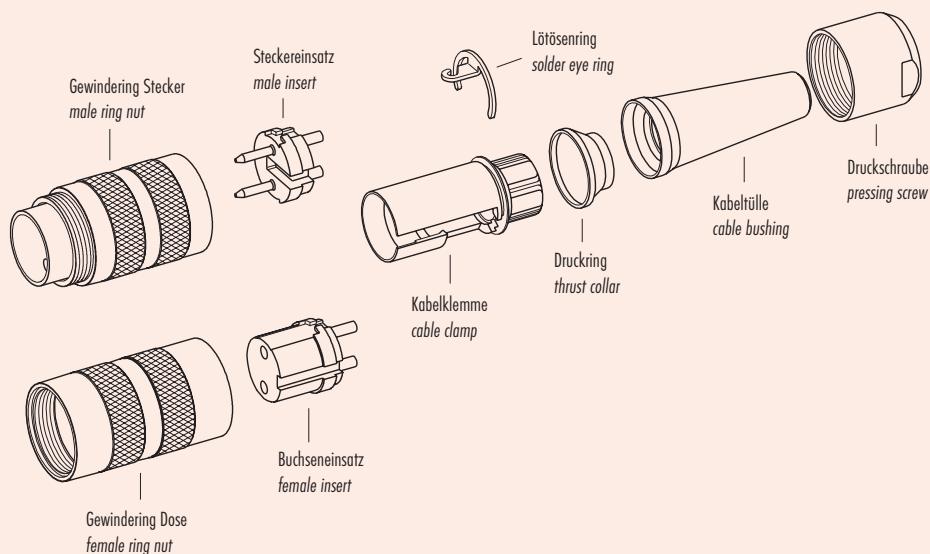

Kabelsteckverbinder mit Kabelklemme
Cable connector with cable clamp

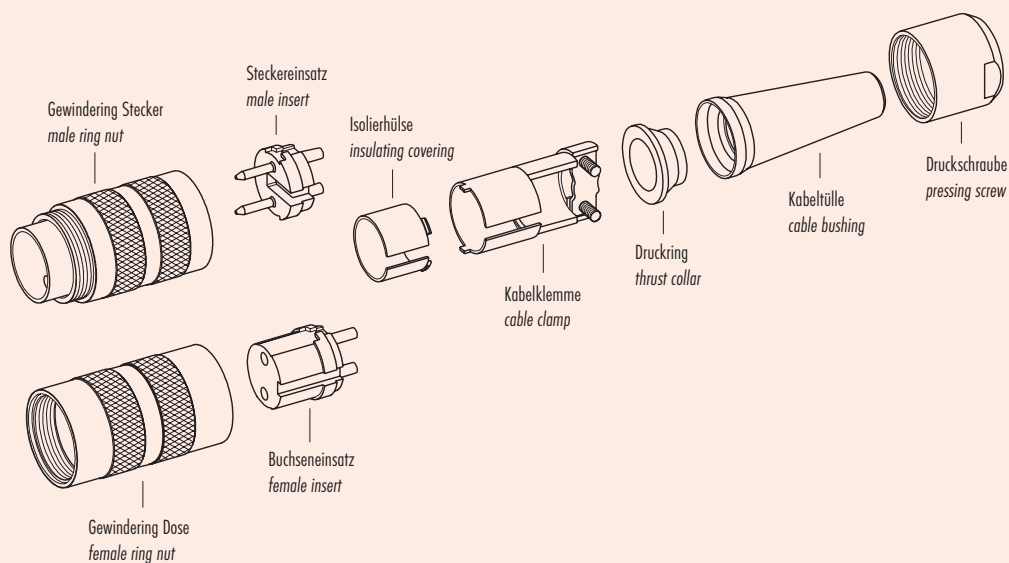

Schirmdämpfungskurve nach DIN 47250-6 für Kabelsteckverbinder mit Kabelklemme (Kabeltyp: IEEE 802.3)
Attenuation curve according to DIN 47250-6 for cable connector with cable clamp (cable version: IEEE 802.3)

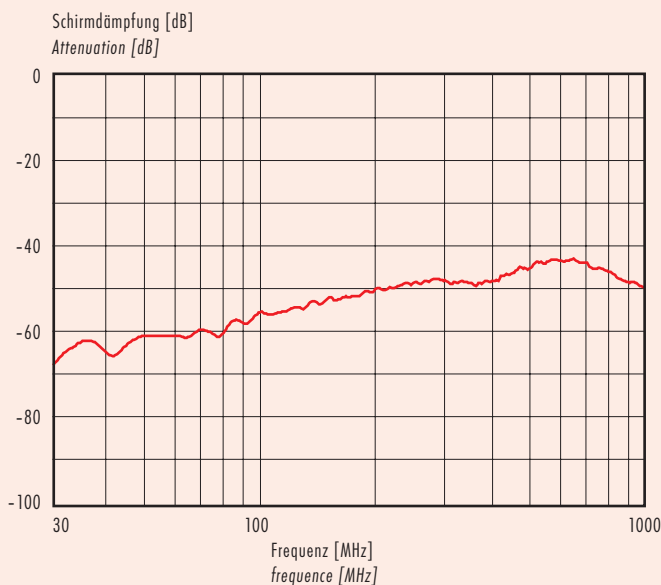

620
702
709
710
711
712
719
423
425
440
581
678
680
682
720
723
623
690
691
692
693
694
707
713
718
733
763
765
768
714
715
766
815
820
825
876
772
775
A
B
C
R

Ü
TI

620
702
709
710
711
712
719
423
425
440
581
678
680
682
720
723
623
690
691
692
693
694
707
713
718
733
763
765
768
714
715
766
815
820
825
876
772
775
A
B
C

R

Miniatur Rundsteckverbinder Serie 581 Miniature circular connectors series 581

Zubehör Accessories

Bezeichnung Description	Abbildung Figure	Maßzeichnung Drawing	Bestell-Nr. Ordering-No.
Schutzkappe für Kabelstecker, IP 67 Protection cap for male cable connector, IP 67			08-1077-000-000
Schutzkappe für Kabeldose, IP 67 Protection cap for female cable connector, IP 67			08-1078-000-000
Schutzkappe für Flanschstecker, IP 67 Protection cap for male socket, IP 67			08-1079-000-000
Schutzkappe für Flanschdose, IP 67 Protection cap for female socket, IP 67			08-1080-000-000
Schutzkappe für Flanschstecker, IP 67 Protection cap for male socket, IP 67			08-2670-000-000
Schutzkappe für Flanschdose, IP 67 Protection cap for female socket, IP 67			08-2671-000-000
Blindstopfen Blind plug			08-2668-000-001

Miniatur Rundsteckverbinder Serie 581 <i>Miniature circular connectors series 581</i>		Zubehör <i>Accessories</i>	
Bezeichnung <i>Description</i>	Abbildung <i>Figure</i>	Maßzeichnung <i>Drawing</i>	Bestell-Nr. <i>Ordering-No.</i>
Schutzkappe für Kabel- und Flanschstecker, staubdicht, IP 54 <i>Protection cap for male cable connector and male socket, dustproof, IP 54</i>			02-0054-000
Schutzkappe für Kabel- und Flanschdose, staubdicht, IP 54 <i>Protection cap for female cable connector and female socket, dustproof, IP 54</i>			02-0055-001
			02-0055-000 (schwarz/black)
Distanzhülse für Flanschsteckverbinder, Tauchlötversion, 2-19 contacts <i>Distance shell for socket, dip solder version, 2-19 contacts</i>			02-0007-000
Montageschlüssel für Kabelsteckverbinder <i>Mounting spanner for cable connector</i>			02-1785-000
Viereckflansch für Flanschsteckverbinder <i>Rectangular flange for socket</i>			08-0045-000-001
Lötösenring <i>Solder eye ring</i>			04-0186-009
6-kant Mutter <i>Hexagonal nut</i>			01-0146-001 ¹⁾
			01-5006-001 ²⁾
			01-0010-001 ^{1) 3)}

¹⁾ 2,5 mm/.10

²⁾ 5 mm/.20

³⁾ Mit Rändel/With knurled screw

Ü
TI

Miniatur Rundsteckverbinder Serie 581 Miniature circular connectors series 581

Zeichnungen Drawings

09-0327-65-07

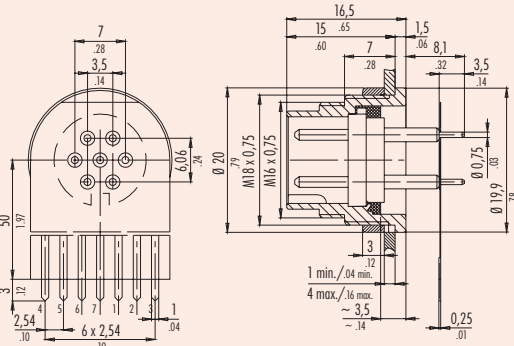

09-0328-65-07

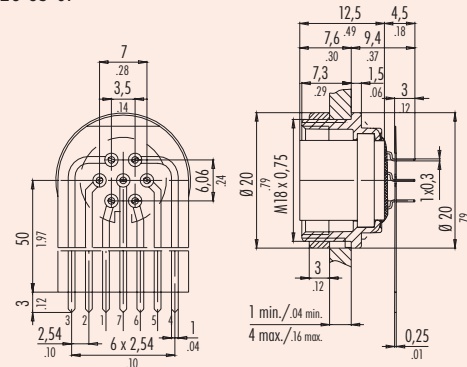

09-0473-65-08

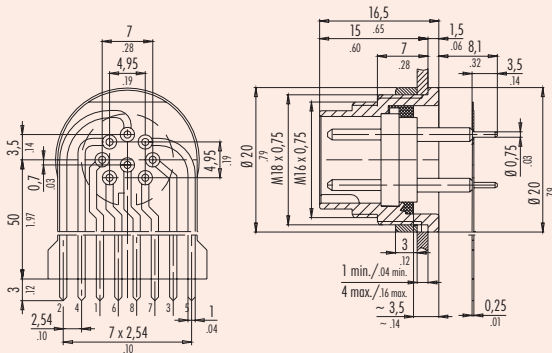

09-0474-65-08

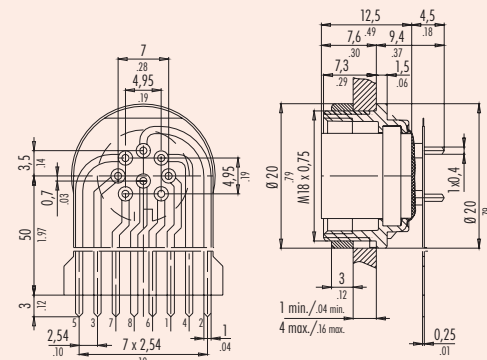

09-0331-65-12

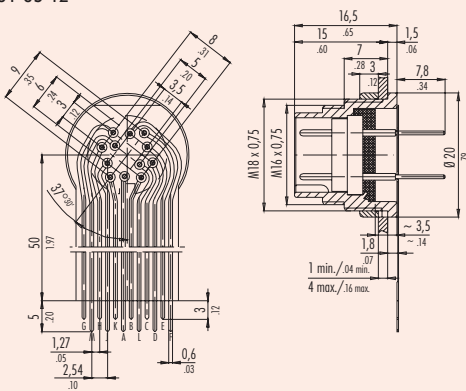

09-0332-65-12

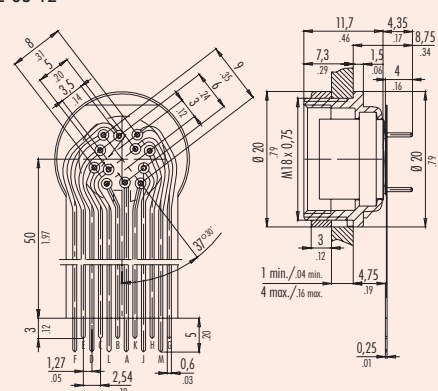

09-0331-66-12

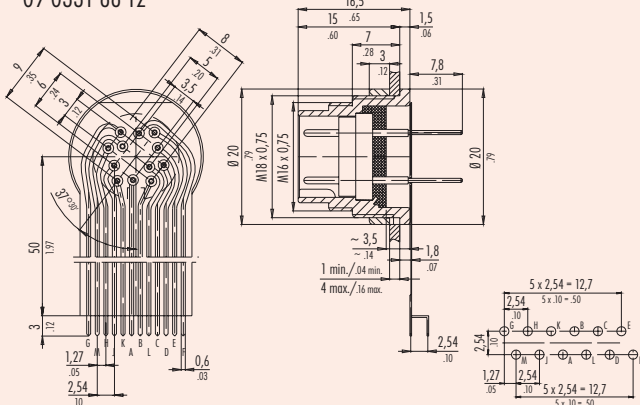

09-0332-66-12

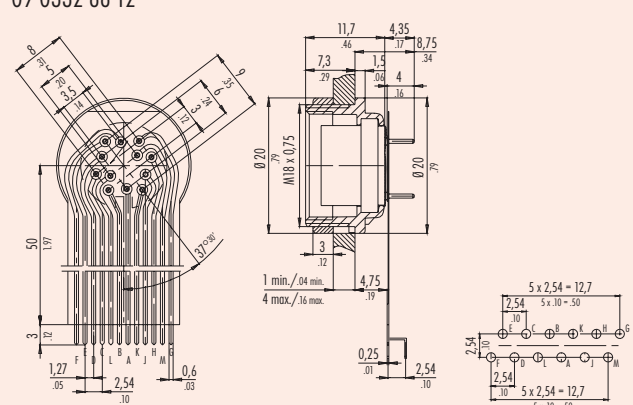

620
702
709
710
711
712
719
423
425
440

581
678
680
682
720
723
623
690
691
692
693
694

707
713
718
733
763
765
768
714
715
766

815
820
825
876
772
775
A
B
C
R