



Serie 691

Maschinen Rundsteckverbinder Serie 691 Circular connectors for machines series 691

Kurzinformation Brief information

Kabelsteckverbinder

- Steckverbinder mit Schraubverriegelung
- Schutzart IP 40¹⁾
- Integrierte Kabelzugentlastung
- Transparenter Kabelknickschutz

Cable Connector

- Connector with screw locking
- Degree of protection IP 40¹⁾
- Internal strain relief
- Transparent cable bushing

Aufbau des Steckverbinders:
Construction of the connector:

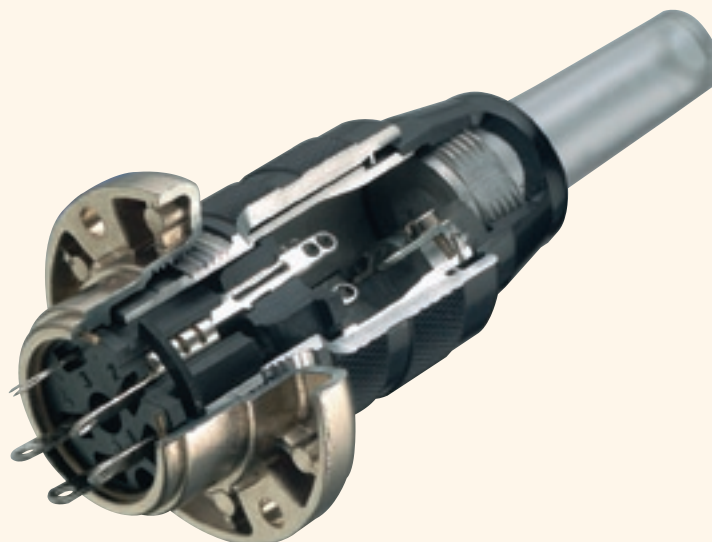

Flanschsteckverbinder

- Steckverbinder wird von vorn in den Montageausschnitt eingesetzt und wird von vorn verschraubt. (Befestigungsschrauben sind nicht in der Lieferung enthalten)
- Metallausführung

Sockets

- Front mounting into housing and fastened from front side. (Screws are not included)
- Metal construction

Flanschstecker:
Male socket:



Flanschdose:
Female socket:



¹⁾ Erläuterung der Schutzarten siehe Seite TI-3 – TI-4. / ¹⁾ Explanation of protection standards see page TI-3 – TI-4.







Maschinen Rundsteckverbinder Serie 691 Circular connectors for machines series 691		Technische Daten ¹⁾ Specifications ¹⁾			
Allgemeine Kennwerte		General Characteristics			
Polzahl	Number of contacts	3	5	7	12
Verriegelung	Locking system	schrauben / screw			
Anschlussart	Termination	löten / solder			
Anschlussquerschnitt in mm ²	Wire gauge in mm ²	max. 1,5		max. 0,75	
Anschlussquerschnitt in AWG	Wire gauge in AWG	max. 16		max. 20	
Kabeldurchlass	Cable outlet	5 - 8 mm (.20 - .32)			
Schutzart Gehäuse	Shell protection	IP 40			
Mechanische Lebensdauer	Mechanical operation	> 500 Steckzyklen / > 500 mating cycles			
Obere Grenztemperatur	Upper temperature	+ 85 °C (+ 185 °F)			
Untere Grenztemperatur	Lower temperature	- 40 °C (- 40 °F)			
Gewicht Kabelsteckverbinder	Weight cable connector	~ 40 g			
Gewicht Flanschsteckverbinder	Weight socket	~ 30 g			
Elektrische Kennwerte		Electrical Characteristics			
Bemessungsspannung	Rated voltage	250 V		125 V	
Bemessungs-Stoßspannung	Rated impulse voltage	2500 V		1500 V	
Verschmutzungsgrad	Pollution degree	1			
Überspannungskategorie	Overvoltage categorie	II			
Isolierstoffgruppe	Material group	III			
Prüfstoßspannung	Test voltage	2950 V		1750 V	
Bemessungsstrom (40 °C)	Rated current (40 °C)	10 A		5 A	
Durchgangswiderstand	Contact resistance	≤ 5 mΩ		≤ 8 mΩ	
Isolationswiderstand	Insulation resistance	≥ 10 ¹⁰ Ω			
Werkstoffe		Materials			
Kontaktstift	Pin contact	CuZn (Messing/brass)			
Kontaktbuchse	Socket contact	CuSn (Bronze/bronze)			
Kontaktoberfläche	Contact plating	Ag (Silber/silver) / 7 + 12 p. Stift (Male contacts) CuZnSn			
Steckerkörper	Male insert	PBT (UL 94 V-0)		PET (UL 94 V-0)	
Buchsenkörper	Female insert	PBT (UL 94 V-0)		PET (UL 94 V-0)	
Gehäuse Kabelstecker	Housing cable connector	GD - Al (eloxiert/anodized)			
Verriegelungsring	Ring nut	GD - Al (eloxiert/anodized)			
Flanschgehäuse	Socket	Zink-Druckguss, vernickelt/zinc diecasting, nickel plated			

¹⁾ Normen und Prüfbedingungen für diese Angaben siehe Seite TI-16. / Standards and test parameters for this data see page TI-16.

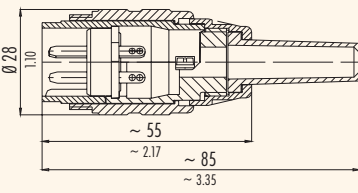
Ü
TI

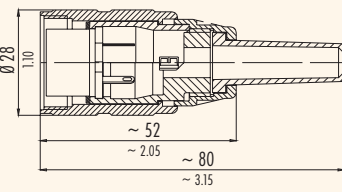
Maschinen Rundsteckverbinder Serie 691 Circular connectors for machines series 691

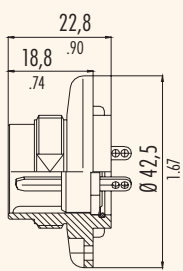
Steckverbinder Connectors

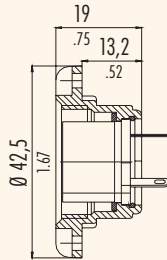
Bezeichnung – Abbildung Description – Figure	Maßzeichnung Drawing	Polzahl Contacts	Bestell-Nr. Ordering-No
Kabelstecker Male cable connector 		3	09-0033-00-03
		5	09-0037-00-05
		7	09-0041-00-07
		12	09-0445-00-12
Kabeldose Female cable connector 		3	09-0034-00-03
		5	09-0038-00-05
		7	09-0042-00-07
		12	09-0446-00-12
Flanschstecker Male socket 		3	09-0035-00-03
		5	09-0039-00-05
		7	09-0043-00-07
		12	09-0447-00-12
Flanschdose Female socket 		3	09-0036-00-03
		5	09-0040-00-05
		7	09-0044-00-07
		12	09-0448-00-12

620
702
709
710
711
712
719
423
425
440
581
678
680
682
720
723
623
690
691
692
693
694
707
713
718
733
763
765
768
714
715
766
815
820
825
876
772
775
A
B
C
R

Maschinen Rundsteckverbinder Serie 691 Circular connectors for machines series 691

Einzelteildarstellung Component part drawings

Kabelstecker
Male cable connector

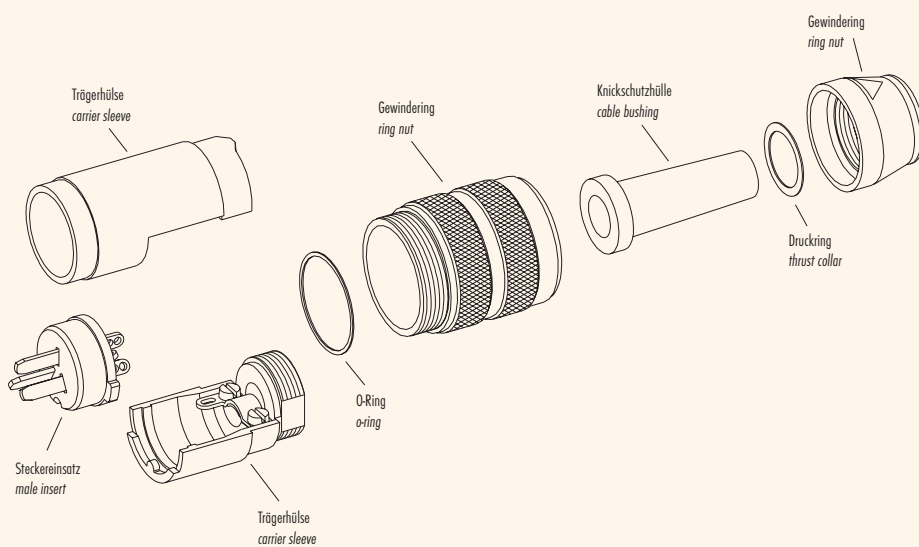

Kabeldose
Female cable connector

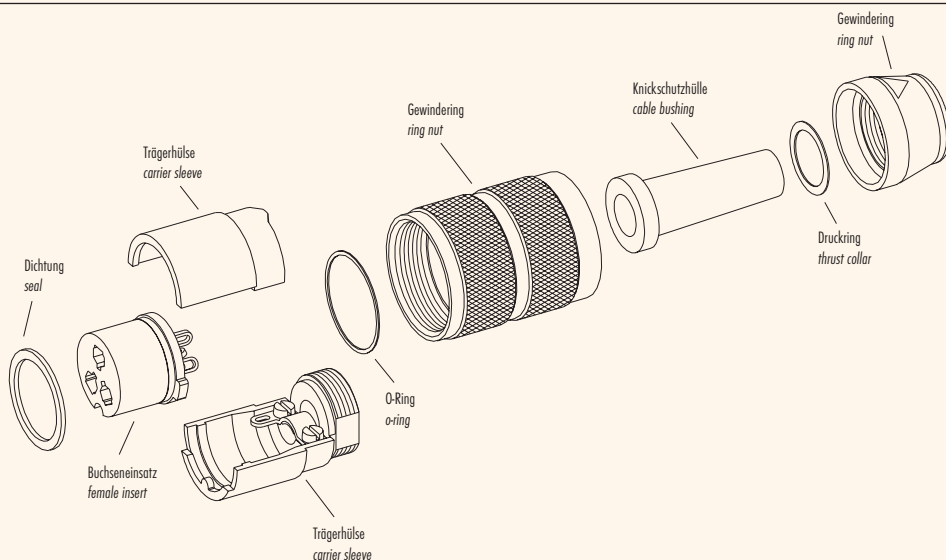

Montageausschnitt
Panel cut out

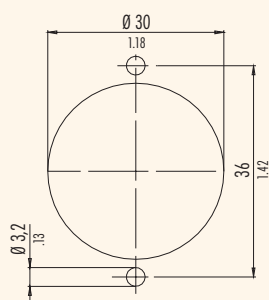

Polbilder mit Sicht auf
Lötanschlussseite der
Stifteinsätze
Contact arrangements with
view on solder termination
side of male inserts

3 Pol
3 contacts

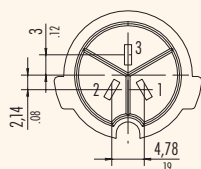

5 Pol
5 contacts

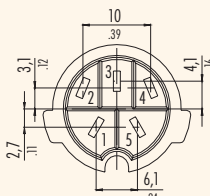

7 Pol
7 contacts

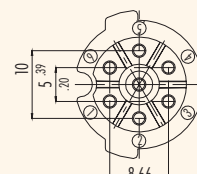

12 Pol
12 contacts

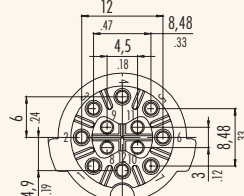

- 620
- 702
- 709
- 710
- 711
- 712
- 719
- 423
- 425
- 440
- 581
- 678
- 680
- 682
- 720
- 723
- 623
- 690
- 691
- 692
- 693
- 694
- 707
- 713
- 718
- 733
- 763
- 765
- 768
- 714
- 715
- 766
- 815
- 820
- 825
- 876
- 772
- 775
- A
- B
- C
- R

Ü

TI

620

702

709

710

711

712

719

423

425

440

581

678

680

682

720

723

623

690

691

692

693

694

707

713

718

733

763

765

768

714

715

766

815

820

825

876

772

775

A

B

C

R