



Product information GDM 3011 schwarz/black

Industrial Connecting Solutions:Rectangular Connectors:Valve Connectors (Type A -B -C):Type A:Field Attachable Valve Connectors:Valve Connectors (DIN EN 175 301-803):GDM 3011 schwarz/black
<http://e-catalog.hirschmann.com/link/57078-24228-256261-256266-256270-276215-24311-34891/en/conf/uisstate>

Name GDM 3011 schwarz/black



cable socket with central screw M 3 x 35

Delivery informations

Availability available

Product description

Description cable socket with central screw M 3 x 35

Type GDM 3011 schwarz/black

Order No. 931 952-100

Other standard types grey housing, Order no. 931 952-106

Number of contacts 3 + PE

Cable gland PG 11

Conductor size max. 1.5 mm²

Standard DIN EN 175 301-803-A

Housing Color black

Construction type A

Technical data

Pin dimensions 6.3 mm x 0.8 mm, 4.8 mm x 0.8 mm

Rated voltage AC/DC 250 V

Rated current 16 A

Contact resistance <= 4 mOhm

Type of termination screw

Suitable cables 6 mm to 9 mm diameter

Mounting central nut

Material

Contact surface material Sn

Contact bearer material PA

Housing material PA

Environmental conditions

Protection class (IEC 60529) IP 65 (gasket necessary)

Pollution severity 3

Temperature range -40 °C to +125 °C

Inflammability class

Housing 94 HB

Contact bearer 94 HB

Approvals

VDE VDE

SEV SEV

CSA CSA

Packing unit

Packaging unit 200 pieces

Scope of delivery and accessories

Accessories to order separately (NBR) flat gasket GDM 3-7, Order no. 730 801-002; (EPDM) flat gasket GDM 3-21, Order no. 731 739-004; profiled gasket GDM 3-16, Order no. 731 531-002; knurled screw GDM 3011-8, Order no. 732 574-001; stainless steel screw GDM 3011 RF-1, Order no. 734 363-001



HIRSCHMANN

A BELDEN BRAND

Industrial Connecting Solutions:Rectangular Connectors:Valve Connectors (Type A -B -C):Type A:Field Attachable Valve Connectors:Valve Connectors (DIN EN 175 301-803):GDM 3011 schwarz/black
<http://e-catalog.hirschmann.com/link/57078-24228-256261-256266-256270-276215-24311-34891/en/conf/ui/state>

Picture

Drawing

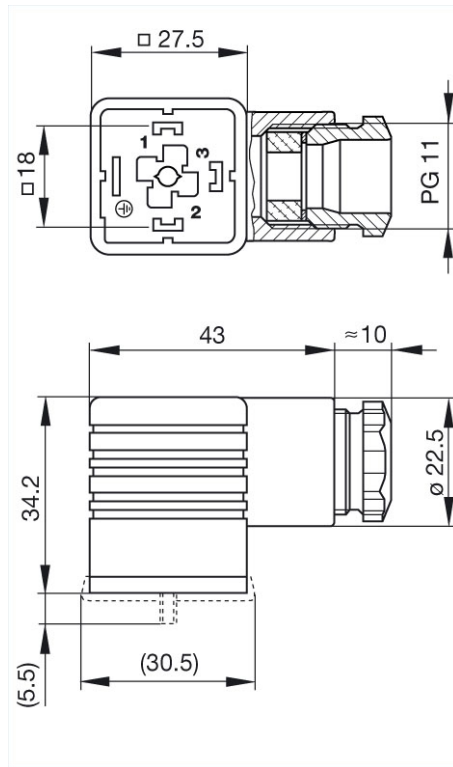

Belden Deutschland GmbH

Im Gewerbepark 2
58579 Schalksmühle
Germany
Phone: +49 7127/14-1806
E-Mail: icos-sales@belden.com

The information published in the websites has been compiled as carefully as possible. It is subject to alteration without notice in technical as well as in price-related/commercial respect. The complete information and data were available on user documentation. Mandatory information can only be obtained by a concrete query.