



Push Switch

Rating	16A 125V AC 1/8HP 10A 250V AC 1/3HP 	Mounting Hole	Diagram												
	10A 250V ~ 														
Contact Resistance	50m ohm Max.														
Insulation Resistance	DC 500V 100M ohm Min.														
Dielectric Strength	AC 1500V 1 minute														
Operation Temperature	-20°C~85°C	<table border="1"> <tr> <td>Panel Thickness</td> <td>X</td> <td>Y</td> </tr> <tr> <td>0.75...1.25</td> <td>19.2-0.1</td> <td>13+0.1</td> </tr> <tr> <td>1.25...2</td> <td>19.4-0.1</td> <td>13+0.1</td> </tr> <tr> <td>2...3</td> <td>19.8-0.1</td> <td>13+0.1</td> </tr> </table>	Panel Thickness	X	Y	0.75...1.25	19.2-0.1	13+0.1	1.25...2	19.4-0.1	13+0.1	2...3	19.8-0.1	13+0.1	
Panel Thickness	X	Y													
0.75...1.25	19.2-0.1	13+0.1													
1.25...2	19.4-0.1	13+0.1													
2...3	19.8-0.1	13+0.1													
Switch Function	2P SPST ON-OFF														

*** Material**

Frame: Nylon#66, Black

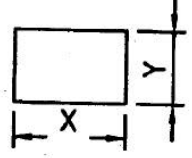
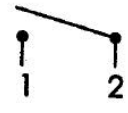
Actuator: Nylon#66, Black

Terminal: Silver plated, Copper alloy

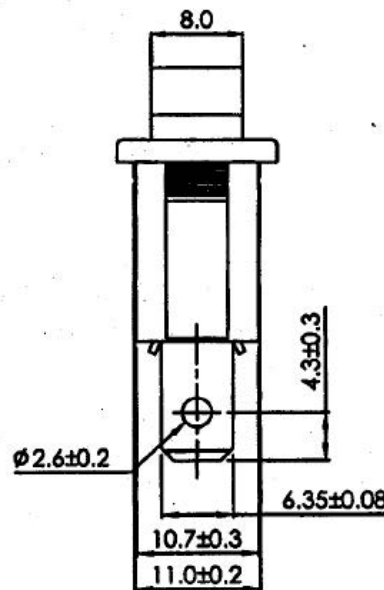
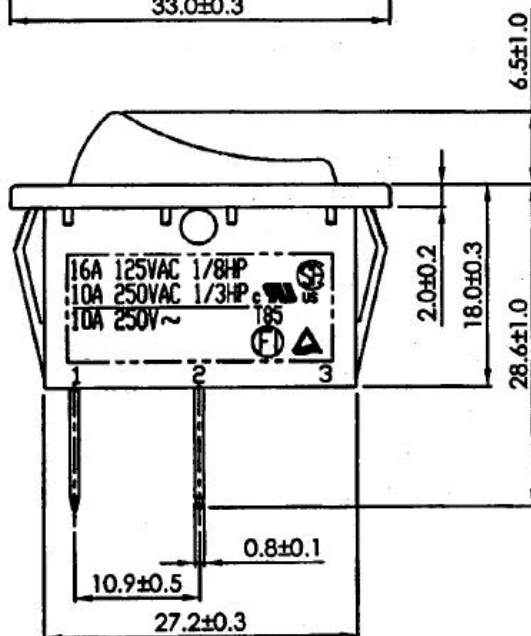
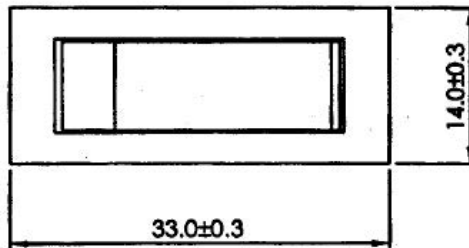

Unit: mm