

Order code	Manufacturer code	Description
78-0620	n/a	TACTILE SWITCH 6X6MM HEIGHT 4.3MM (RC)
78-0621	n/a	TACTILE SWITCH 6X6MM HEIGHT 5MM (RC)
78-0622	n/a	TACTILE SWITCH 6X6MM HEIGHT 7MM (RC)
78-0623	n/a	TACT SWIT 6X6MM HEIGHT 7.3MM SQ 2.4MM RC
78-0624	n/a	TACT SWIT 6X6MM HEIGHT 7.3MM SQ 2.8MM RC
78-0625	n/a	TACTILE SWITCH 6X6MM HEIGHT 9.5MM (RC)
78-0626	n/a	TACTILE SWITCH 6X6MM HEIGHT 13MM (RC)

	Page 1 of 5
The enclosed information is believed to be correct, Information may change 'without notice' due to product improvement. Users should ensure that the product is suitable for their use. E. & O. E.	Revision A 04/07/2003

DTS-6.2 SERIES



DIMENSIONS

DTS-61~66 □

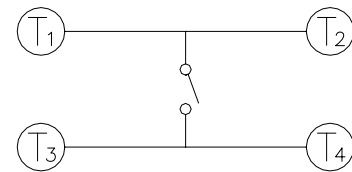
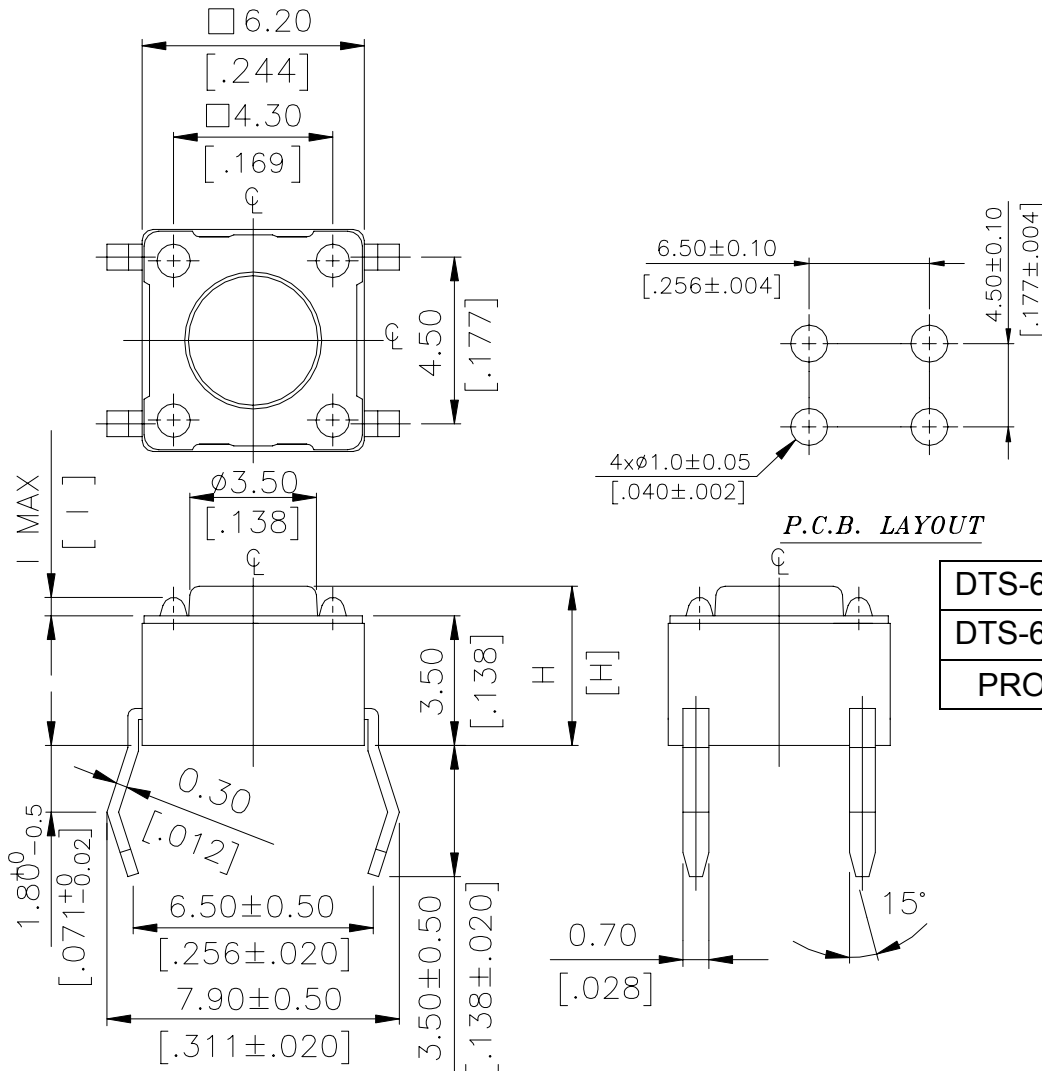

CIRCUIT DIAGRAM

DTS-62~66 □	0.6 MAX	.0236 MAX
DTS-61 □	0.5 MAX	.0197 MAX
PROD.	NO.	I INCHES.

DTS-66 □	13.0 [.512]
DTS-65 □	9.5 [.374]
DTS-63 □	7.0 [.275]
DTS-62 □	5.0 [.197]
DTS-61 □	4.3 [.169]
PROD.	NO. H

General Tolerance : ±0.2mm

DTS-644 · 648 □

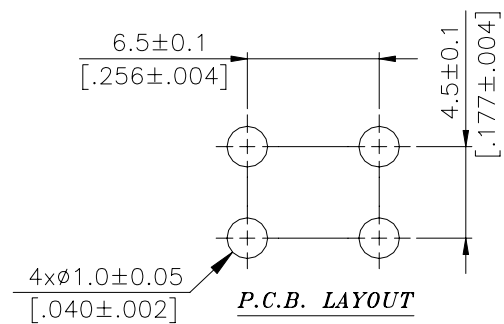
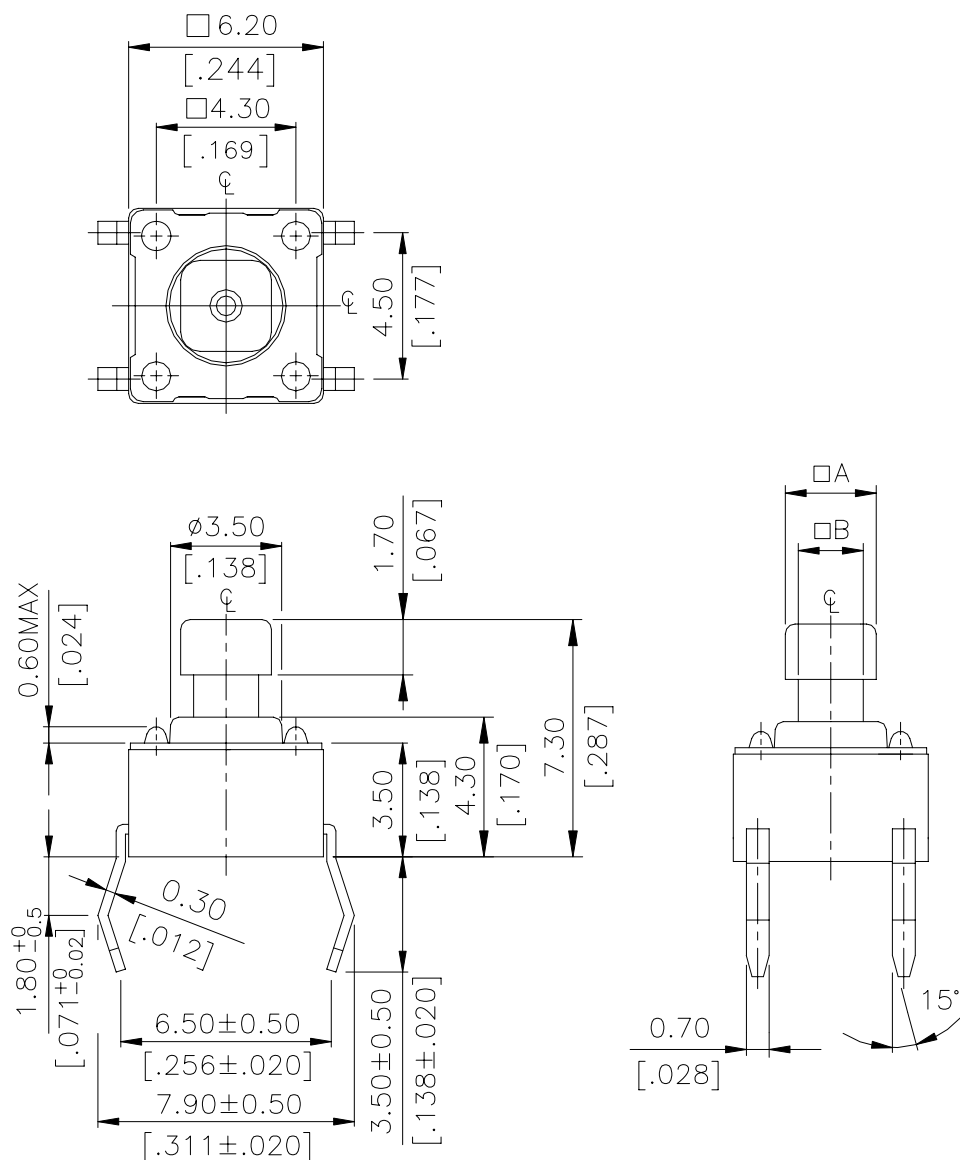

CIRCUIT DIAGRAM

DTS-644 □	□A	2.4	[.095]
	□B	1.6	[.063]
DTS-648 □	□A	2.8	[.110]
	□B	2.0	[.079]
PROD.	NO.	LOC.	MM. INCH.

DIMENSION

General Tolerance : ±0.2mm

DTS-21、25

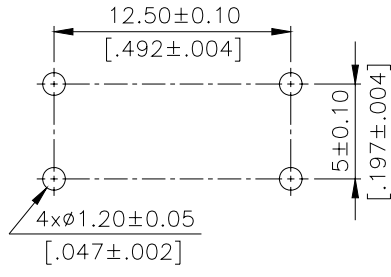
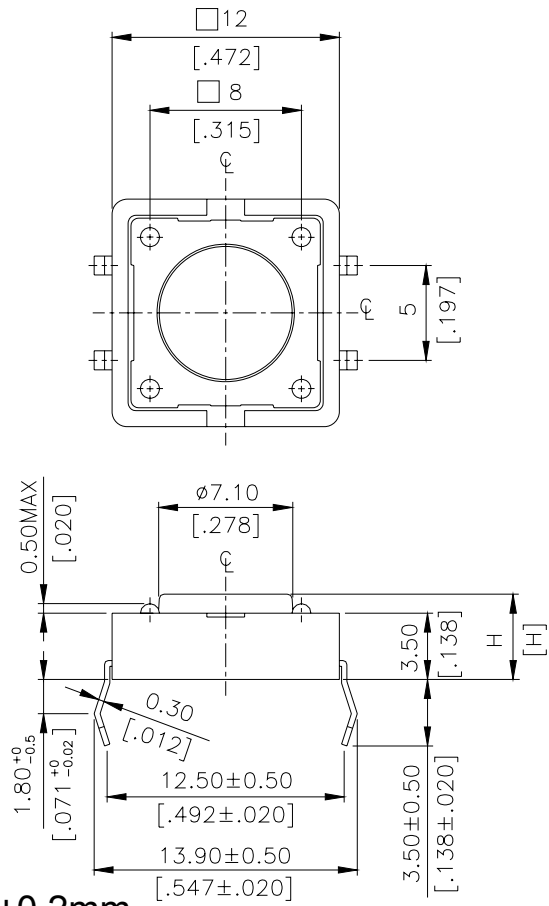

P.C.B. LAYOUT

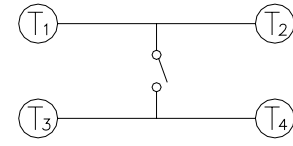

CIRCUIT DIAGRAM

DTS-25	8.5 [0.335]
DTS-21	4.3 [0.169]
PROD. NO.	H
附表 A	

General Tolerance : $\pm 0.2\text{mm}$

DTS-24

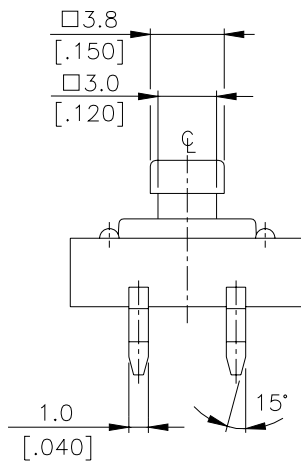
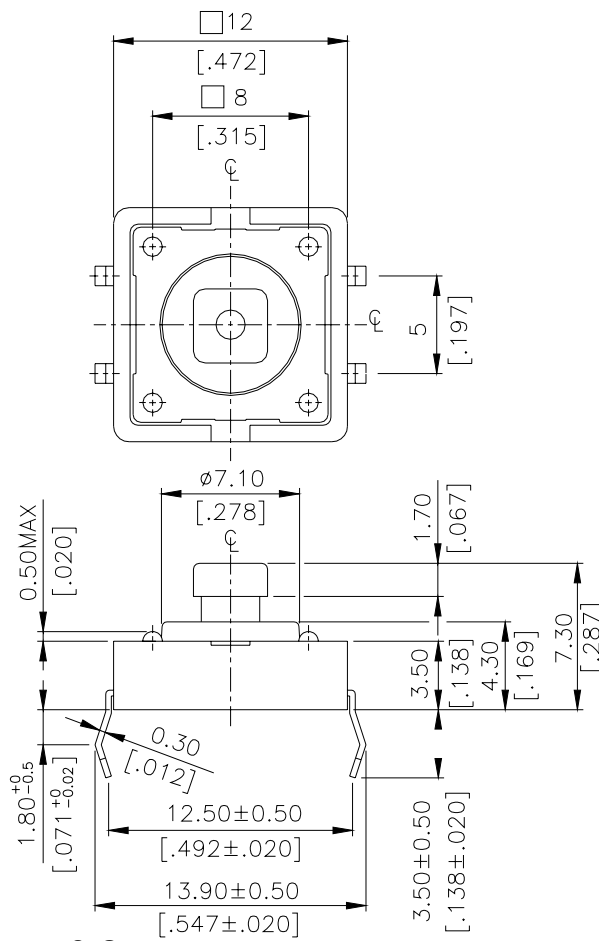

P.C.B. LAYOUT

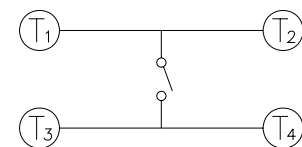
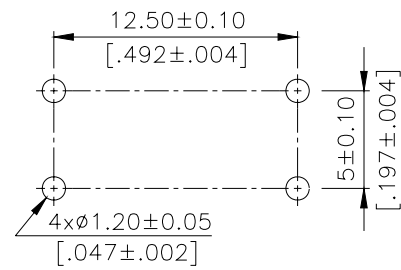

CIRCUIT DIAGRAM

General Tolerance : $\pm 0.2\text{mm}$

DTS-21(063)

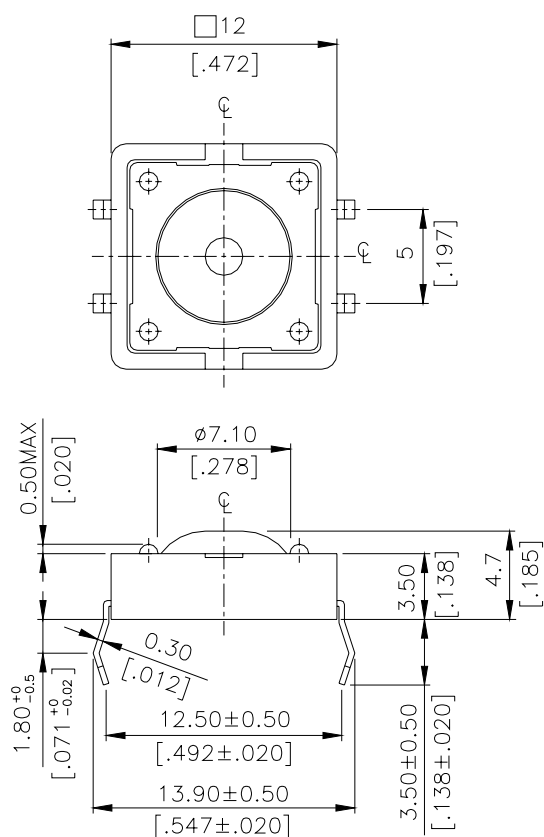

General Tolerance : $\pm 0.2\text{mm}$

HOW TO ORDER

D T S □ - □ □ □ - □ - □ (□□□)

(063) =Silicon Rubber Actuator
[DTS-21 Only]
(231) =Total H : 6.0mm (DTS-6)
(083) =Total H : 12.6mm (DTS-6)

Package style:

□ = Bulk pack
▲ B = Tube
(▲ Except DTS-63, 644,648,65,66)

Soldering:

V = Lead Free Solderable

Color of stem for operating force:

▲ K = Black , 100gf
N = Brown , 160gf
R = Red , 260gf
S = Salmon , 320gf
▲ Y =Yellow , 520gf
(▲ 12x12 K、Y Unavailable)

Dimension H :

◎ 6 X 6 mm	◎ 12 x 12 mm
1 = 4.3 mm	1 = 4.3 mm
2 = 5.0 mm	4 = 7.3 mm (SQ.) x 3.8 mm
3 = 7.0 mm	5 = 8.5 mm
44 = 7.3 mm(SQ.)x2.4 mm	
48 = 7.3 mm(SQ.)x2.8 mm	
5 = 9.51 mm	
6 = 13 mm	

Prod. Size :

6= 6x6 mm
2= 12x12 mm
□ = None Post
▲ =With Post
< ▲ Only For 12x12 >
Tactile Switch

SPECIFICATION

△ MECHANICAL

Operation Force:520±130gf Yellow(Y)
320±80gf Salmon(S)
260±50gf Red(R)
160±50gf Brown(N)
100±50gf Black(K)

Stop Strength: Place the switch such that vertical, a static load of 3 kgf shall be applied in the direction of stem operation for a period Of 15 seconds.

Stroke : (12x12) 0.35±0.1mm
(6x6) 0.25+0.2/-0.1mm

Operation Temperature Range : -25°C to +70°C

Storage Temperature Range : -30°C to +80°C

△ ELECTRICAL (6X6)

Electrical Life : 300,000 cycles for 320gf,520gf
500,000 cycles for 260gf
1,000,000 cycles for 100gf,160gf

Rating : 50 Ma , 12 VDC

Contact Resistance : 100mΩ max

Insulation Resistance : 100MΩ min , 500 VDC

Dielectric Strength : 250 VAC / minute

Contact Arrangement : 1 pole 1 throw

MATERIAL

△ COVER : Stainless steel

△ CONTACT DISC : Phosphor bronze with silver cladding

△ TERMINAL : Brass with silver plated

△ BASE : UL94V-0 Nylon Thermoplastic

△ STEM : UL94V-0 Nylon Thermoplastic

Color : Black(100gf) , Brown(160gf) , Red(260gf)

Salmon(320gf) , Yellow(520gf)

Silicon Rubber Color : Red (300gf) [DTS-21 Only]

CAP : Termoplastic ABS

△ ELECTRICAL (12X12)

Electrical Life: 100,000 cycles for 320gf

100,000 cycles for 260gf

200,000 cycles for 160gf

SOLDERING PROCESS

△WAVE SOLDERING: Recommended solder temperature at 500°F(260°C)max. 5 seconds subject to PBC 1.6mm thickness (For through hole type)

△Hand soldering : Use a soldering iron of 30 watts , controlled at 350°C approximately max 5 seconds while applying solder.

PACKING

Part Number	Number Per Bag	Number Per Tube
DTS-6□□□	1000	-
DTS-61	-	77
DTS-62	-	77
DTS-2	500	-
DTS-2□□	-	39

DTS-61.62 TUBE

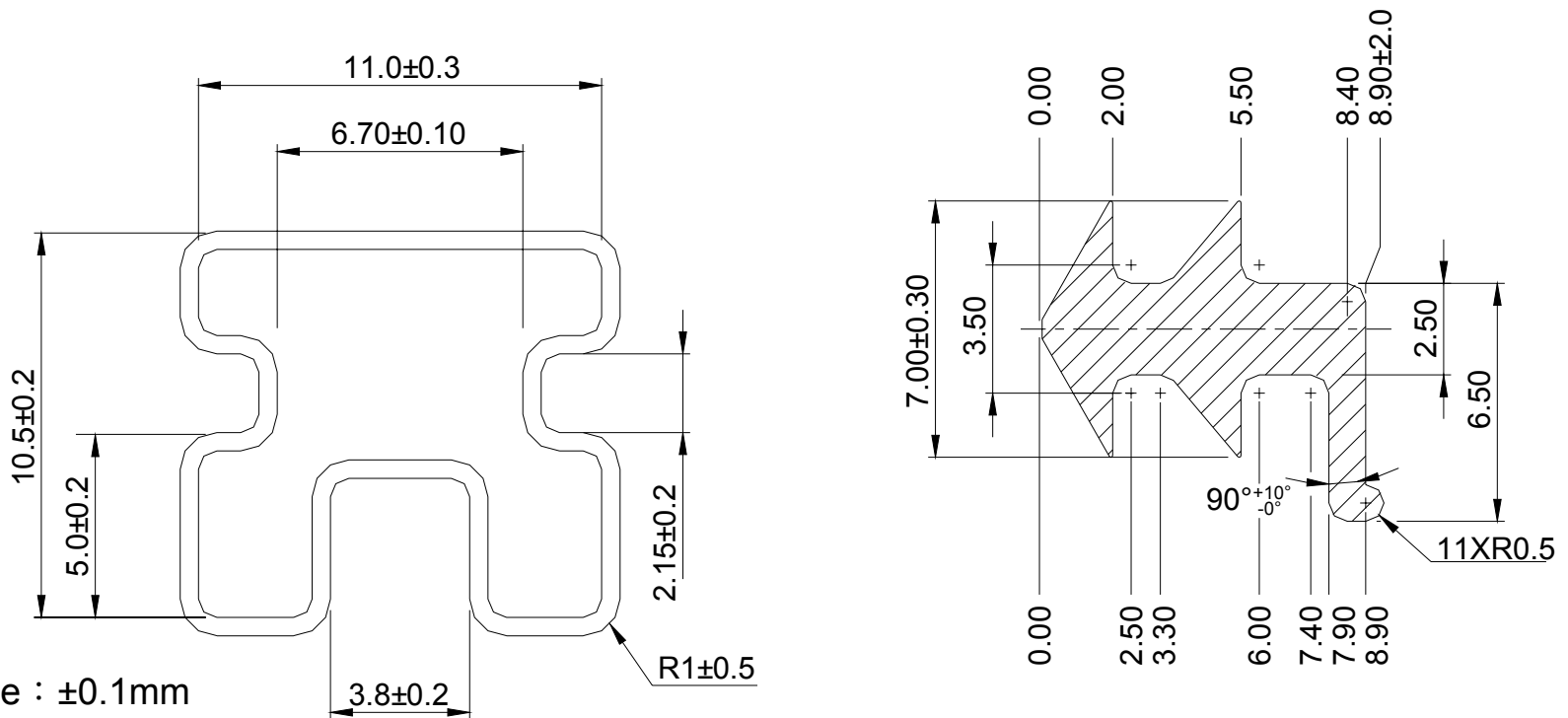

General Tolerance : $\pm 0.1\text{mm}$

DTS-2 □ □ TUBE

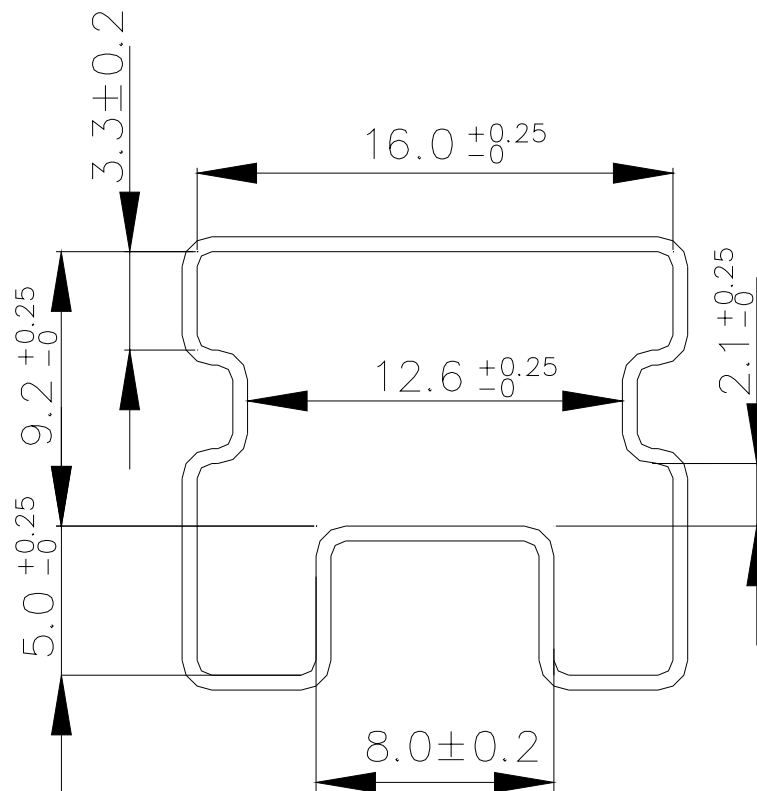

General Tolerance : $\pm 0.1\text{mm}$