

FSR® 400 Series Data Sheet

Force Sensing Resistors®

Features and Benefits

- Actuation Force as low as 0.2N and sensitivity range to 20N
- Cost Effective
- Ultra Thin
- Robust; up to 10M actuations
- Simple and easy to integrate

Description

Interlink Electronics FSR® 400 series is part of the single zone Force Sensing Resistor® family. Force Sensing Resistors®, or FSRs®, are robust polymer thick film (PTF) devices that exhibit a decrease in resistance with increase in force applied to the surface of the sensor. This force sensitivity is optimized for use in human touch control of electronics devices such as automotive electronics, medical systems, industrial, and robotics applications.

The 400 series sensors come in six different models with four different connecting options.



P/N: 94-00027 Rev. E

Embrace the Power of Sensor Technologies

Device Characteristics

Actuation Force*	~0.2N min
Force Sensitivity Range*	~0.2N – 20N
Force Resolution	Continuous (analog)
Force Repeatability Single Part	+/- 2%
Force Repeatability Part to Part	+/- 6% (Single Batch)
Non-Actuated Resistance	>10 Mohms
Hysteresis	+10% Average (RF+ - RF-)/RF+
Device Rise Time	< 3 Microseconds
Long Term Drift 1kg load, 35 days	< 5% log10(time)
Operating Temperature Performance Cold: -40°C after 1 hour Hot: +85°C after 1 hour Hot Humid: +85°C 95RH after 1 hour	-5% average resistance change -15% average resistance change +10% average resistance change
Storage Temperature Performance Cold: -25°C after 120 hours Hot: +85°C after 120 hours Hot Humid: +85°C 95RH after 240 hours	-10% average resistance change -5% average resistance change +30% average resistance change
Tap Durability Tested to 10 Million actuations, 1kg, 4Hz	-10% average resistance change
Standing Load Durability 2.5kg for 24 hours	-5% average resistance change
EMI	Generates no EMI
ESD	Not ESD Sensitive
UL	All materials UL grade 94 V-1 or better
RoHS	Compliant

Connector Options

Bare Tail

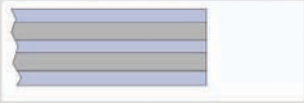

Female Tin Contacts
PN: TE 2-487406-4

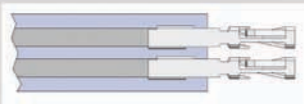

Female Tin Contacts with 2 Pin Housing
PN: TE 2-487406-4
PN: TE 2-487378-1



Solder Tabs
PN: TE 1-88997-2

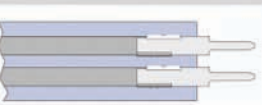

Other Available Part Numbers:
Hardware Development Kit, PN 54-76247

Application Information

For specific application needs please contact Interlink Electronics support team. An Integration Guide and Hardware Development Kit (HDK) are also available. FSR®s are two-wire devices with a resistance that depends on applied force. Below is a force vs. resistance graph that illustrates a typical FSR® response characteristic. Please note that the graph values are reference only and actual values are dependent upon actuation system mechanics and sensor geometry.

For simple force-to-voltage conversion, the FSR® device is tied to a measuring resistor in a voltage divider (see figure below) and the output is described by the following equation.

$$V_{OUT} = \frac{R_M V_+}{(R_M + R_{FSR})}$$

In the shown configuration, the output voltage increases with increasing force. If RFSR and RM are swapped, the output swing will decrease with increasing force. The measuring resistor, RM, is chosen to maximize the desired force sensitivity range and to limit current. Depending on the impedance requirements of the measuring circuit, the voltage divider could be followed by an op-amp.

A family of force vs. VOUT curves is shown on the graph below for a standard FSR® in a voltage divider configuration with various RM resistors. A V+ of 5V was used for these examples. Please note that the graph values are for reference only and will vary between different sensors and applications.

Refer to the FSR® Integration Guide for more integration methods and techniques.

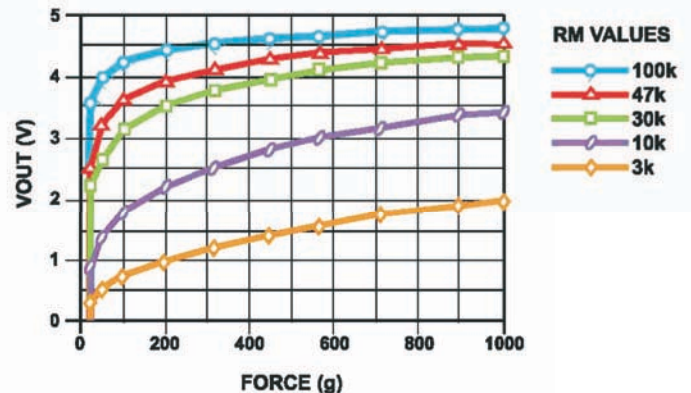
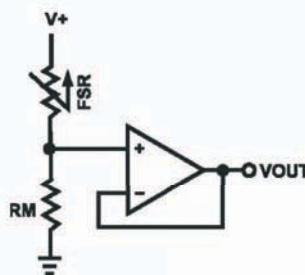
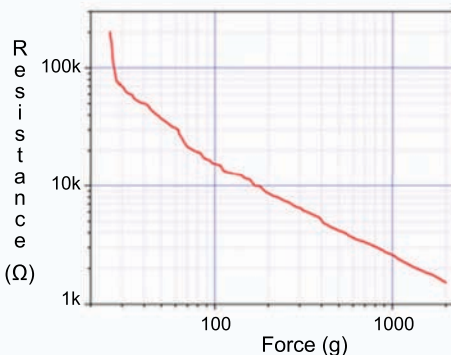

FSR® Model 400

Force Sensing Resistor®

Model 400:

Active Area: $\varnothing 5.08\text{mm}$
Nominal Thickness: 0.30mm
Switch Travel: 0.05mm

Available Part Numbers:

PN: 34-00007 Model 400
- No contacts or solder tabs
PN: 34-00011 Model 400
- with female contacts
PN: 34-44001 Model 400
- with female contacts and housing
PN: 30-49649 Model 400
- with solder tabs

Sensor Mechanical Data

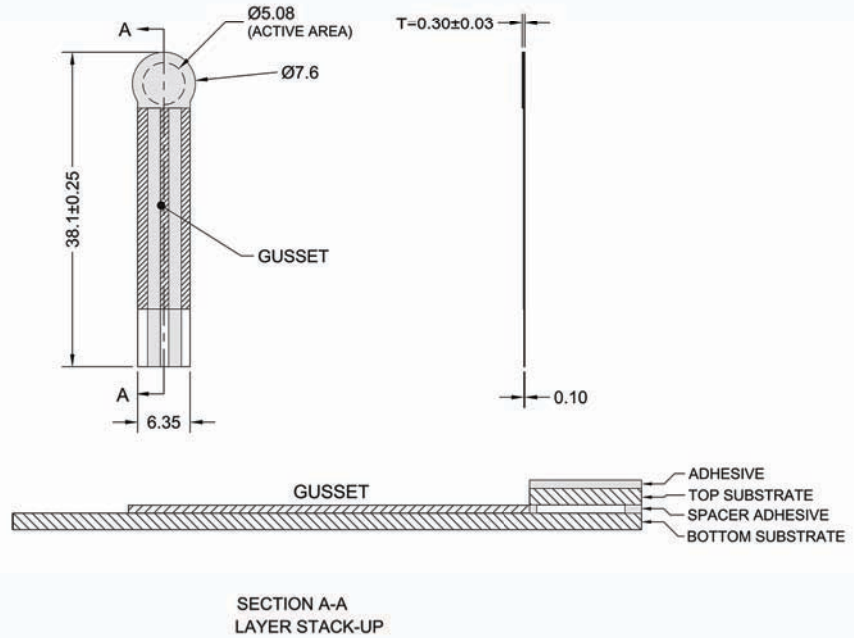

Exploded View

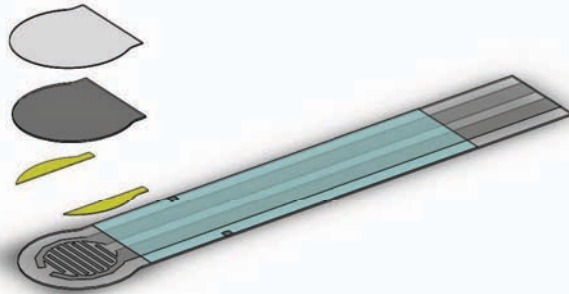

FSR® Model 400 Short Tail

Force Sensing Resistor®

Model 400 Short Tail:

Active Area: $\varnothing 5.62\text{mm}$
Normal Thickness: 0.30mm
Switch Travel: 0.05mm

Available Part Numbers:

PN: 34-47021 Model 400 Short Tail
- No contacts or solder tabs
PN: 34-00005 Model 400 Short Tail
- with female contacts
PN: 34-00006 Model 400 Short Tail
- with female contacts and housing
PN: 34-00004 Model 400 Short Tail
- with solder tabs

Sensor Mechanical Data

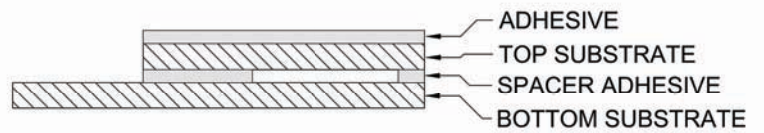
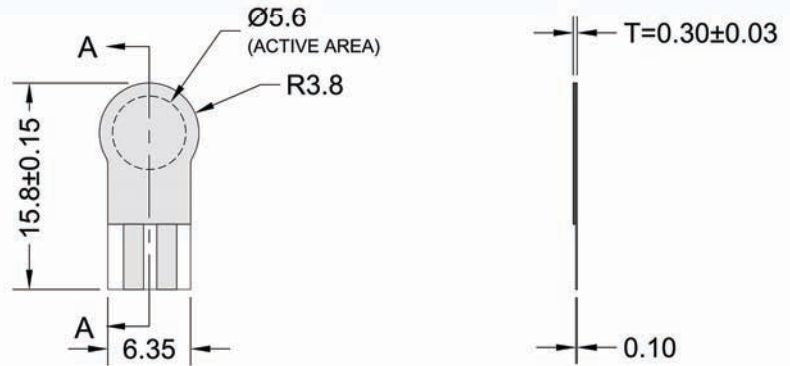

SECTION A-A
LAYER STACK-UP

Exploded View

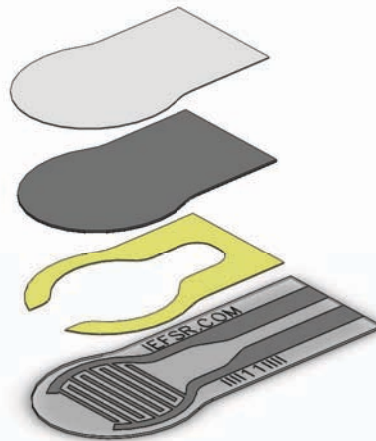

FSR® Model 402

Force Sensing Resistor®

Model 402:

Active Area: $\varnothing 14.68\text{mm}$
Nominal Thickness: 0.46mm
Switch Travel: 0.15mm

Available Part Numbers:

PN: 44-29103 Model 402
- No contacts or solder tabs
PN: 34-00012 Model 402
- with female contacts
PN: 34-00001 Model 402
- with female contacts and housing
PN: 30-81794 Model 402
- with solder tabs

Sensor Mechanical Data

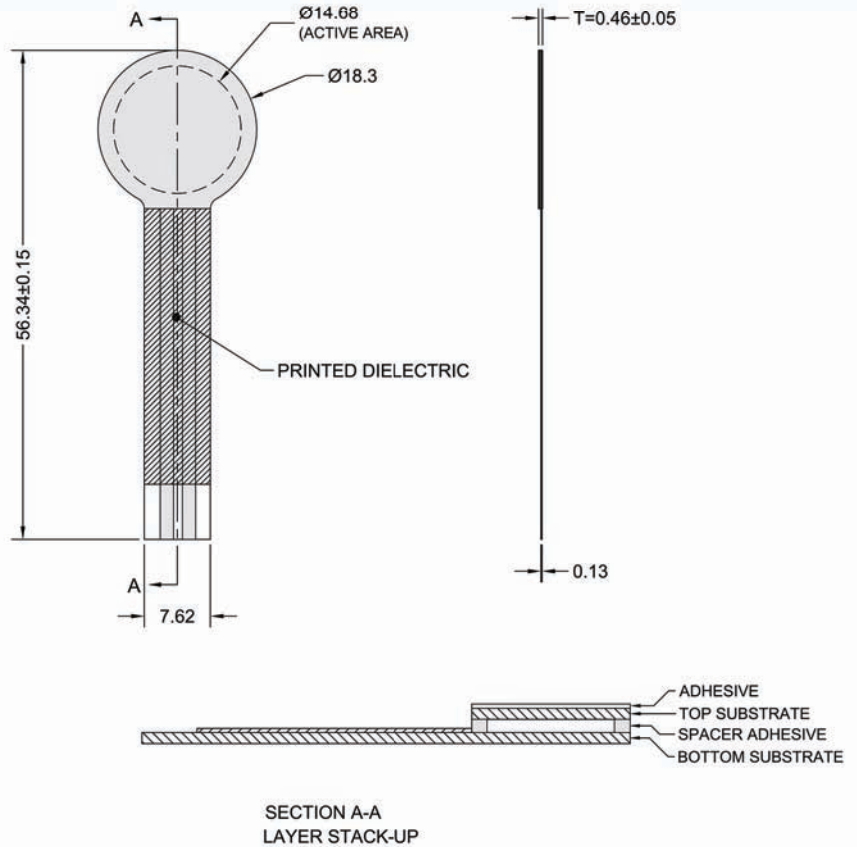

Exploded View

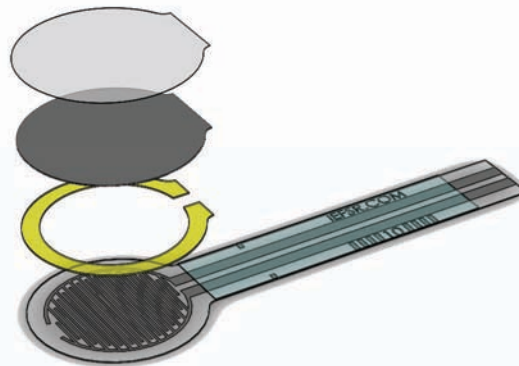

FSR® Model 402 Short Tail

Force Sensing Resistor®

Model 402 Short Tail:

Active Area: $\varnothing 12.70\text{mm}$
Normal Thickness: 0.46mm
Switch Travel: 0.15mm

Available Part Numbers:

PN: 34-00016 Model 402 Short Tail
- No contacts or solder tabs
PN: 34-00017 Model 402 Short Tail
- with female contacts
PN: 34-00018 Model 402 Short Tail
- with female contacts and housing
PN: 34-00015 Model 402 Short Tail
- with solder tabs

Sensor Mechanical Data

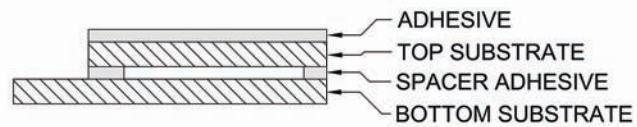
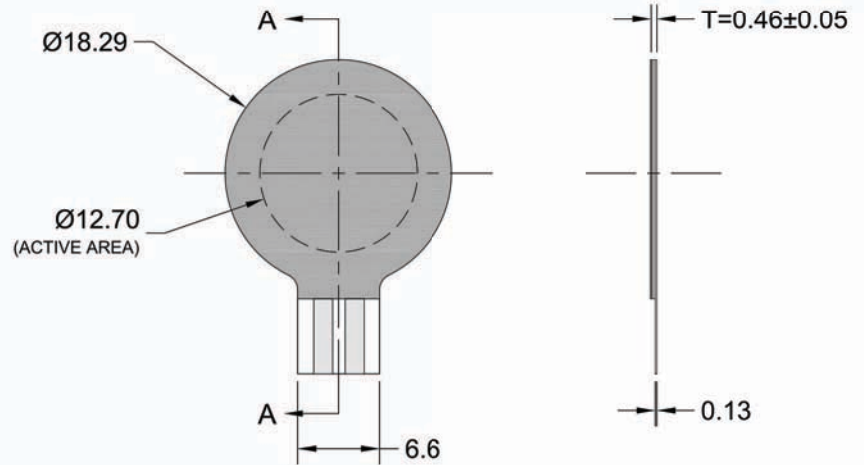

SECTION A-A
LAYER STACK-UP

Exploded View

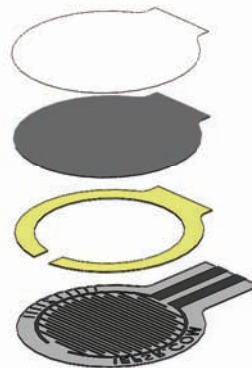

FSR® Model 406

Model 406:

Active Area: 39.6mm x 39.6mm
Nominal Thickness: 0.46mm
Switch Travel: 0.15mm

Available Part Numbers:

PN: 34-00009 Model 406
- No contacts or solder tabs
PN: 34-00013 Model 406
- with female contacts
PN: 34-61152 Model 406
- with female contacts and housing
PN: 30-73258 Model 406
- with solder tabs

Sensor Mechanical Data

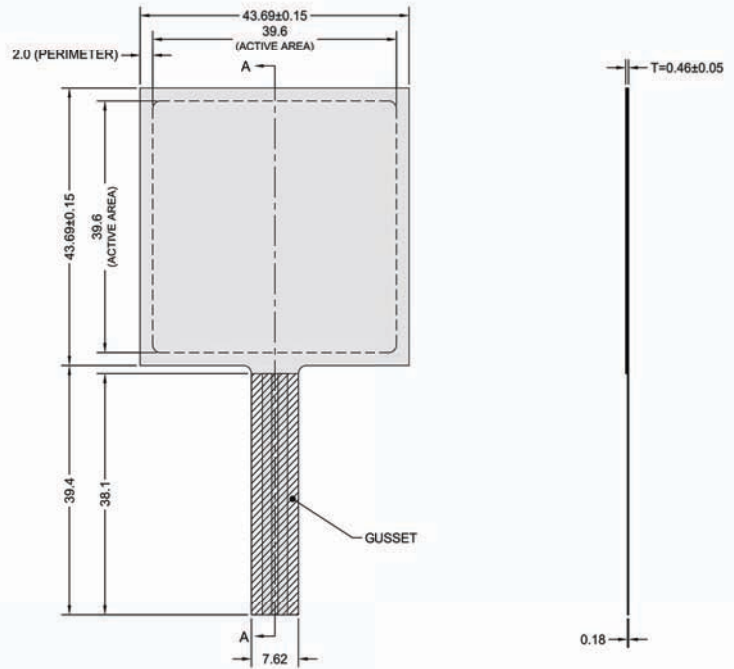

Exploded View

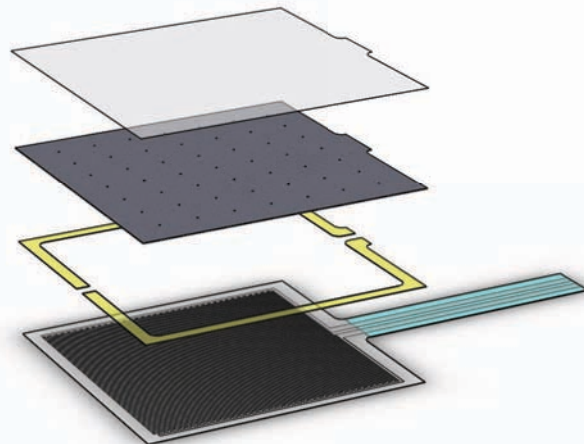

FSR® Model 408

Force Sensing Resistor®

Model 408:

Active Area: 609.6mm x 10.2mm

Nominal Thickness: 0.41mm

Switch Travel: 0.15mm

Available Part Numbers:

PN: 34-00010 Model 408

- No contacts or solder tabs

PN: 34-75319 Model 408

- with female contacts

PN: 34-23845 Model 408

- with female contacts and housing

PN: 30-61710 Model 408

- with solder tabs

Sensor Mechanical Data

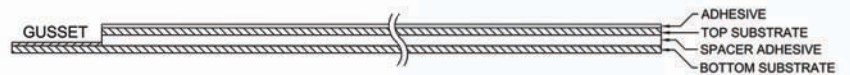
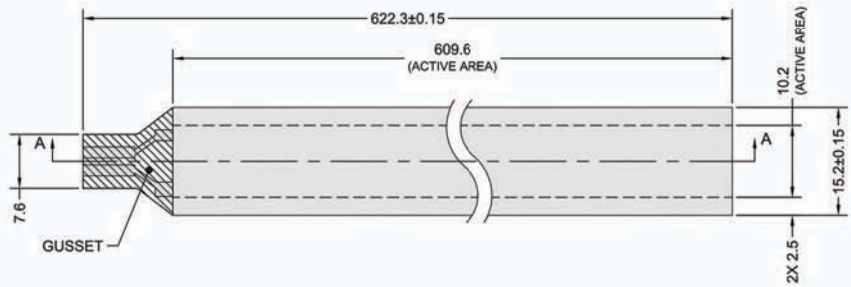

SECTION A-A
LAYER STACK-UP

Exploded View

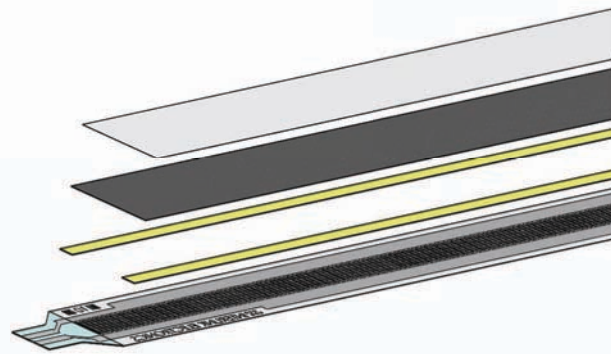

Contact Us

United States Corporate Office

Interlink Electronics, Inc.
546 Flynn Road
Camarillo, CA 93012, USA
Phone: +1-805-484-8855
Fax: +1-805-484-9457
www.interlinkelectronics.com
Sales and Support:
sales@interlinkelectronics.com

Japan

Japan Sales Office
Phone: +81-45-263-6500
Fax: +81-45-263-6501
www.interlinkelec.co.jp