

CONTENTS :

PAGE1 - CONTENTS

PAGE2 - CAMERA

REVISION HISTORY:

R0 - 20/04/2022 - Initial prototype

R1 - 26/09/2022 - PVT - removed SOT23 crypto chip

		© Raspberry Pi 2022 www.raspberrypi.org	
Raspberry Pi Camera Module 3		Drawn By Simon Martin	
Size A3	Ref RPI-CAM-V3AF_R1	Rev R1	
Date: Tuesday, June 20, 2023		Sheet 1 of 2	

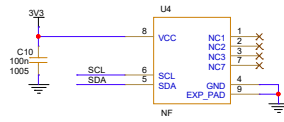
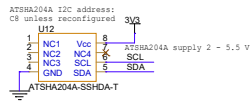
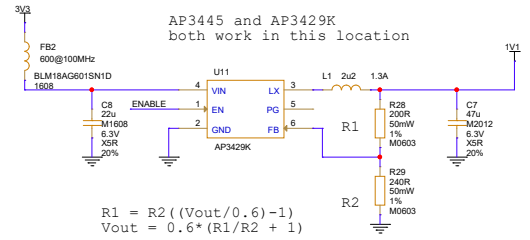
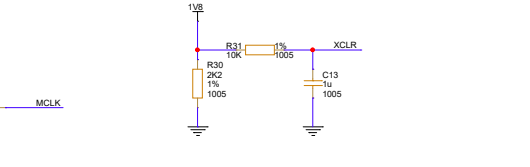
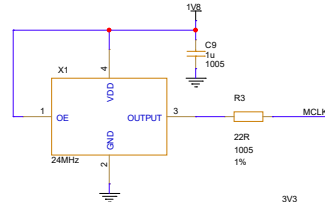
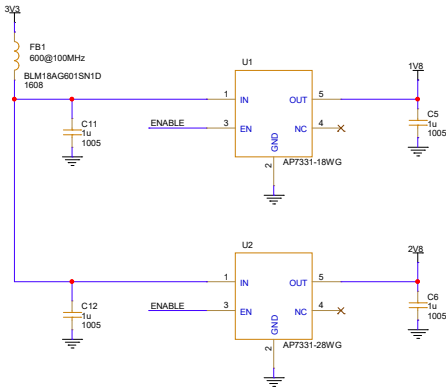
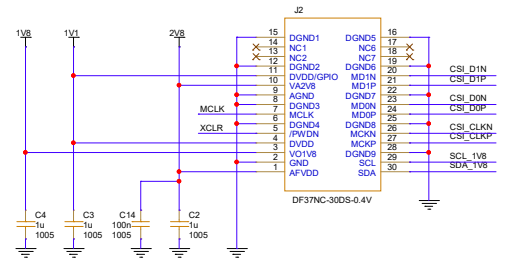
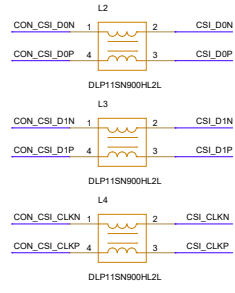
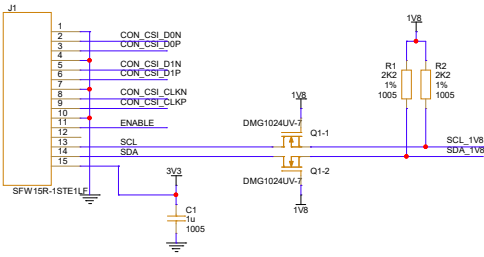

 **Raspberry Pi** © Raspberry Pi 2022
www.raspberrypi.org

File		Drawn By	
Raspberry Pi Camera Module 3		Simon Martin	
Size	Ref		Rev
A3	RPI-CAM-V3AF_R1		R1
Date:	Tuesday, June 20, 2023	Sheet	2 of 2